



# Grid

## In This Section:

- Horizontal Cover Style
- Vertical Cover Style
- Full Spacer Style
- Half Spacer Style





# Grid

## Safety Warning

When using Lovejoy products, you must follow these instructions and take the following precautions. Failure to do so may cause the power transmission product to break and parts to be thrown with sufficient force to cause severe injury or death.

Refer to this Lovejoy Catalog for proper selection, sizing, horsepower, torque range, and speed range of power transmission products, including elastomeric elements for couplings. Follow the installation instructions included with the product, and in the individual product catalogs for proper installation of power transmission products. Do not exceed catalog ratings.

During start up and operation of power transmission product, avoid sudden shock loads. Coupling assembly should operate quietly and smoothly. If coupling assembly vibrates or makes beating sound, shut down immediately, and recheck alignment. Shortly after initial operation and periodically thereafter, where applicable, inspect coupling assembly for: alignment, wear of elastomeric element, bolt torques, and flexing elements for signs of fatigue. Do not operate coupling assembly if alignment is improper, or where applicable, if elastomeric element is damaged, or worn to less than 75% of its original thickness.

Do not use any of these power transmission products for elevators, man lifts, or other devices that carry people. If the power transmission product fails, the lift device could fall resulting in severe injury or death.

For all power transmission products, you must install suitable guards in accordance with OSHA and American Society of Mechanical Engineers Standards. Do not start power transmission product before suitable guards are in place. Failure to properly guard these products may result in severe injury or death from personnel contacting moving parts or from parts being thrown from assembly in the event the power transmission product fails.

If you have any questions, contact the Lovejoy Engineering Department at 1-630-852-0500.



# Grid

## Table of Contents

	Running Page No.	Section Page No.
Overview.....	216	GD-4
Selection Process.....	217	GD-5
Application Service Factors > Selection Data .....	219	GD-7
Grid Coupling Selection Worksheet.....	221	GD-9
Standard Coupling > Performance Data .....	222	GD-10
Standard Coupling > Dimensional Data .....	223	GD-11
Spacer Style > Performance / Dimensional Data .....	224	GD-12
Spacer Style > Spacer Hub Selection .....	225	GD-13
Misalignment Capability > Item Selection.....	226	GD-14
Industry Standard Interchange Chart > Item Selection .....	227	GD-15
Grid Coupling Hubs – Inch Bore / Keyway > Item Selection .....	228	GD-16
Grid Coupling Hubs – Metric Bore / Keyway > Item Selection .....	229	GD-17
Grid Coupling – Taper Lock Hubs > Item Selection.....	230	GD-18
Grid Coupling – Component Part Numbers > Item Selection.....	231	GD-19

## The Power of Torsional Dampening

Lovejoy is pleased to be able to provide quality grid couplings covering a large number of industry standard sizes and lengths. The Lovejoy grid style coupling has proven itself in performance and popularity over a wide range of applications.

Lovejoy's grid style coupling design has demonstrated its ability to dampen vibration by as much as 30% and can cushion shock loads that could cause damage to both the driving and driven equipment. The tapered grid spring design absorbs impact energy by spreading the energy out over the full length of the grid spring thus reducing the magnitude of the torque spikes.

The Lovejoy design uses a curved hub tooth profile which creates a progressive contact with the flexible grid spring as the application torque increases. This feature provides a more effective and efficient transmission of power in properly aligned couplings.

Lovejoy's versatile design of industry standard hubs and grid springs for both horizontal and vertical cover styles allow Lovejoy couplings to be interchangeable with other industry standard grid couplings and components.

Proper grid coupling installation and maintenance can add to a longer coupling life. Grid spring replacement is simple and can be performed at a fraction of the cost and time of a complete coupling.

GD

### Features

- High tensile, shot-peened alloy steel grid springs and precision machined hubs ensure superior coupling performance and long life.
- Lovejoy's grid couplings with tapered grids are designed to be interchangeable with other industry standard grid couplings with both horizontal and vertical grid covers.
- Lovejoy grid couplings are designed for ease of installation and maintenance reducing labor and downtime costs.
- The torsional flexibility and resilience of Lovejoy grid couplings helps reduce vibration and cushions shock and impact loads.
- Cover fasteners can be provided in either Inch or Metric sizes.
- Excellent for use in applications where the equipment is close coupled or spaced apart requiring a spacer style coupling arrangement.
- Stock spacer designs are available or requests for custom spacer lengths can be addressed by Lovejoy engineering.



#### Horizontal Split Cover Design

- Ideal for limited space
- Allows easy access to the grid spring
- Well suited for reversing applications
- Lightweight die-cast aluminum grid cover



#### Vertical Split Cover Design

- Ideal for higher operating speeds
- Allows easy access to the grid spring
- Cover is manufactured from stamped steel for strength



#### Full Spacer Design – Horizontal Cover

- Drop-out design ideal for pump applications and servicing
- Stock sizes 1020 thru 1090
- Lightweight die-cast aluminum grid cover



#### Half Spacer Design – Horizontal Cover

- Offers additional BSE dimensions
- Lightweight die-cast aluminum grid cover



### WARNING

You must refer to page GD-2 (page 214) for Important Safety Instructions and Precautions for the selection and use of these products. Failure to follow the instructions and precautions could lead to severe injury or death.

## Grid Coupling Selection Process

The following information is necessary when making a Grid coupling selection:

- Description of motor or engine, the horse power (or KW), and RPM at slowest coupling speed while under load
- Description of the driven equipment
- Shaft and keyway sizes and the type of fit for driver and driven equipment (clearance or interference)\*\*
- Shaft separation (BSE)
- Physical space limitations (see Application Worksheet)
- Determine what the environmental conditions will be, such as temperature, corrosive conditions, interference from surrounding structures, etc.

\*\* By default, sizes 1020 – 1090 will be clearance fit, sizes 1100 – 1200 will be interference fit.

\*\* Lovejoy machines all bores and keyways to meet the dimensional and tolerance specifications per ANSI/AGMA 9002-B04 for inch bores, or ISO 286-2 for metric bores.

Typical grid couplings consist of two grid hubs, a grid spring, and a cover assembly. When the shaft separation requires a spacer style coupling, the coupling will consist of two shaft hubs, two spacer hubs, a grid spring, and a horizontal cover assembly.

The following charts are available to assist in making the best possible grid coupling selection:

- Coupling Selection Worksheet, Page GD-9
- Grid Standard Interchange Chart, Page GD-15
- Application Service Factors, Pages GD-7 and GD-8
- General Service Factors, Page GD-6 (bottom)
- Performance and Dimensional Data for Standard Grid Couplings, Page GD-10 thru GD-11
- Performance and Dimensional Data for Spacer Grid Couplings, Page GD-12
- Grid Coupling Part Numbers for Standard Components, Page GD-16 thru GD-19

### Formulas Used To Calculate Torque:

$$\text{Application Torque (in-lbs)} = \left( \frac{\text{horse power} \times 63025}{\text{RPM}} \right)$$

$$\text{Application Torque (Nm)} = \left( \frac{\text{horse power} \times 9550}{\text{RPM}} \right)$$

$$\text{Selection Torque} = \text{Application Torque} \times \text{Service Factor}$$

### High Peak Loads and Brake Applications

For applications where high peak loads or high braking torques might be present, the following additional information will be necessary:

- System peak torque and frequency
- Duty cycle
- Brake torque rating

The selection torque formula is similar to the formula shown above except that the application torque should be doubled prior to applying the service factor.

$$\text{Application Torque (in-lbs)} = \left( \frac{\text{horse power} \times 63025}{\text{RPM}} \right)$$

$$\text{Application Torque (Nm)} = \left( \frac{\text{horse power} \times 9550}{\text{RPM}} \right)$$

$$\text{Selection Torque} = 2 \times \text{Application Torque} \times \text{Service Factor}$$

Please feel free to contact Lovejoy Application Engineering or Technical Support for assistance with additional grid coupling questions.

## Steps In Selecting A Grid Coupling

**Step 1:** Determine the application torque using the formula shown above.

**Step 2:** Select the Service Factor from the charts on pages GD-7 and GD-8. For applications not displayed use the chart shown to the right. Determine the Selection Torque using the formula shown above.

**Step 3:** Using the selection torque as calculated, refer to the Performance Chart on page GD-10 to determine the minimum size grid coupling that will accommodate the torque.

**Step 4:** Compare the maximum bore for the size selected and ensure the required bore sizes do not exceed the maximum allowable. If the required bore size is larger, step up to the next size coupling and check to see if the bore sizes will fit.

**Step 5:** Using the selected coupling size, compare the bore and keyway sizes with the charts located on pages GD-16 thru GD-17 for UPC part numbers.

**Step 6:** Contact your local industrial supplier with the part numbers to place your order.

See the Selection Example process on the next page.

**Selection Example**

**Application Description**

A company would like to use a grid coupling to connect a standard AC electric motor to a rotary lobe compressor. The electric motor is rated for 60 horsepower running at 1,760 RPM. The shaft size on the electric motor (driver) is 2-1/8 inches with a standard 1/2" square key. The shaft size on the compressor (driven) is 48 millimeters with a standard 14mm key. Both the motor and compressor shaft are 3 inches long and the gap (BSE) between the shaft ends is 1/8 inch.

The following steps provide an excellent selection process that will work for most standard grid coupling selections. For assistance in this selection process, feel free to contact Lovejoy Application Engineering or Technical Support.

**Step 1:** Using the information provided by the customer, determine the application torque:

$$\text{Application Torque (in-lbs)} = \left( \frac{\text{horse power} \times 63025}{\text{RPM}} \right)$$

for this example:

$$\text{Application Torque (in-lbs)} = \left( \frac{60 \times 63025}{1,760} \right) = 2,149 \text{ in-lbs}$$

**Step 2:** Select the application service factor from the chart on pages GD-7 and GD-8 to determine which value best corresponds to an electric motor driven rotary lobe style compressor. In the charts find the application category 'Compressors', 'Rotary lobe and vane', and under the column for 'Electric Motors', is the service factor number 1.25.

If the service factor did not appear on the service factor charts for the defined application, a generic value could be selected from the chart located on the right side of this page.

**Step 3:** Calculate the Selection Torque for the application:

$$\text{Selection Torque} = \text{Application Torque} \times \text{Service Factor}$$

$$\text{Selection Torque} = 2,149 \text{ in-lbs} \times 1.25 = 2,687 \text{ in-lbs}$$

**Step 4:** Reference the Grid Coupling Performance and Dimensional data on pages GD-10 and GD-11. Use the Selection Torque to make an initial selection based on the nominal torque allowed for the coupling size. The first coupling size that can accommodate 2,687 in-lbs or torque is the size 1050 grid coupling with a nominal torque rating of 3,850 in-lbs.

**Step 5:** Note, that the electric motor's 2-1/8 inch shaft diameter exceeds the maximum allowable bore size for a size 1050 coupling which is 1-7/8 inches. Using the same chart, scan the column for maximum bore sizes and find the first coupling size larger than the 1050 that will accommodate the 2-1/8 inch bore size. The size 1060 coupling will accommodate the 2-1/8 inch bore. The horizontal cover can be selected since the application speed of 1,760 RPM does not exceed the coupling's maximum speed of 4,350 RPM.

**Step 6:** Prior to finalizing the 1060 selection, it is always a good idea to review all of the coupling details to ensure the correct coupling has been selected. The following are the comparisons usually made.

	1060 Coupling	Application	Acceptable?
Torque:	6,050 in-lbs	2,687 in-lbs	yes
Bore Size:	2-1/8" max	2-1/8"	yes
BSE	0.13"	1/8"	yes
Speed	4,350 RPM	1,760 RPM	yes
Mount length	5.13" OAL	6-1/8"	yes

Check the Grid Series Misalignment Chart to ensure the application meets the misalignment requirements. If the items above are acceptable and the application misalignment falls within the allowable range of the 1060 grid coupling, the 1060 grid coupling appears to be the correct coupling for this application.

**Step 7:** Using the UPC Selection tables on Pages GD-16 thru GD-19, find the required hubs for the corresponding coupling size and the required Cover and Grid Assembly.

1060 Hub Bore 2-1/8"	see page GD-16, use 05491
1060 Hub Bore 48mm	see page GD-17, use 05815
1060 Horizontal Cover and Grid assembly with inch hardware	see page GD-18, use 05353

Prefix all grid coupling part numbers with 697904

**General Service Factors**

Typical Applications for Electric Motor or Turbine Driven Equipment	Typical Service Factor
Constant Torque such as Centrifugal Pumps, Blowers, and Compressors.	1.0
Continuous Duty with some torque variations including Printing Presses, Extruders, Forced Draft Fans.	1.5
Light shock loads from Briquetting Machine, Rubber Calendar, or Crane and Hoist.	2.0
Moderate shock loading as expected from a Car Dumper, Reciprocating Feeder, or Vibrating Screen.	2.5
Heavy Shock load with some negative torques from Crushers, Manipulators, and Braking Drum.	3.0
For applications like Reciprocating Compressors with frequent torque reversals which do not necessarily cause reverse rotations, contact Lovejoy Technical Support.	

**Application Service Factors**

**Chart 1**

	Service Factors					Service Factors					Service Factors			
	Electric Motor w/ Standard Torque	Reciprocating Engines-4/5 Cylinder	Reciprocating Engines-6 or more Cyl			Electric Motor w/ Standard Torque	Reciprocating Engines-4/5 Cylinder	Reciprocating Engines-6 or more Cyl			Electric Motor w/ Standard Torque	Reciprocating Engines-4/5 Cylinder	Reciprocating Engines-6 or more Cyl	
<b>Aggregate Processing, Cement, Mining Kilns; Tube, Rod and Ball Mills</b>					Coilers (Up or Down) Cold Mills only, Cooling Beds, Mill Tables Hot Bed or					Couch, Cylinder, Dryer, Pulp Grinder, Fourdrinier, Press, Suction Roll.....	1.75	2.75	2.25	
Dryer, Rotary, Hammermill or Hog, Tumbling Mill or Barrel, Direct or on L.S. Shaft of Reducer, with Final Drive of Single Helical or Herringbone Gears...	1.75	2.75	2.25	Transfer, Non-Reversing .....	1.50	2.50	2.00	Barker Auxiliary, Hydraulic, Mechanical, Barking Drum L.S. Shaft of Reducer with Final Drive-Helical or Herringbone Gear, Cutter, Felt Whipper, Jordan, Log Haul .....	2.00	3.00	2.50			
Grizzly, Direct or on L.S. Shaft of Reducer, with Final Drive of Machined Spur Gears.....	2.00	3.00	2.50	Reel Drives, Slitters, Steel Mill only, Wire Drawing Machinery..	1.75	2.75	2.25	Barking Drum L.S. Shaft of Reducer with Final Drive-Machined Spur Gear, Chipper..	2.50	*	*			
Crushers, Ore or Stone .....	2.50	*	*	Coilers (Up or Down) Hot Mills only, Coke Plants Door Opener, Drawbench, Furnace Pushers, Hot and Cold Saws, Ingot Cars, Mill Tables Runout, Non-Reversing, Non-Plugging, Screwdown, Seamless Tube Mills -Thrust Block, Tube Conveyor Rolls, Reeler, Kick Out, Soaking Pit Cover Drives - Travel, Straighteners,				Barking Drum L.S. Shaft of Reducer with Final Drive-Cast Tooth Spur Gear .....	3.00	*	*			
<b>Brewing and Distilling</b>				Unscramblers.....	2.00	3.00	2.50	<b>Rubber Industry</b>						
Bottle and Can Filling Machines, Brew Kettle.....	1.00	2.00	1.50	Coke Plants Pusher Ram Drive, .....	2.50	*	*	Tire/Tube Press Opener (Peak Torque).....	1.00	2.00	1.50			
Cookers, Continuous Duty, Mash Tub .....	1.25	2.25	1.75	Coke Plants Pusher or Larry Car Traction Drive, Feed Rolls-Blooming Mills, Manipulators, Mill Tables Roughing Breakdown Mills, Runout, Reversing, Seamless Tube Mills Piercer, Sideguards .....	3.00	*	*	Extruder, Mixing Mill, Refiner or Sheeter (Five or More in Line), Tuber, Strainer, Pelletizer, Warming Mill (Three or More in Line) .....	1.75	2.75	2.25			
Lauter Tub.....	1.50	2.50	2.00	Cold Mills, Hot Mills, Merchant Mills, Rod Mills, Skelp Mills.....	Refer To Lovejoy			Calender, Mixing Mill, Refiner or Sheeter (Three/Four in Line), Warming Mill (One/Two in Line) .....	2.00	3.00	2.50			
Scale Hopper, Frequent Peaks ...	1.75	2.75	2.25	<b>Oil Industry</b>				Cracker, Plasticator, Mixing Mill, Refiner or Sheeter (One/Two in line), Intensive or Banbury Mixer, Tire Building Machine, Washer.....	2.50	*	*			
<b>Clay Working Industry</b>				Chiller.....	1.25	2.25	1.75	<b>Sewage Disposal Equipment</b>						
Brick Press, Briquette Machine, Clay Working Machine, Plug Mill.....	1.75	2.75	2.25	Paraffin Filter Press .....	1.50	2.50	2.00	Bar Screen, Chemical Feeders, Collectors, Dewatering Screen, Grit Collector .....	1.00	2.00	1.50			
<b>Dredges</b>				Oilwell Pumping (not over 150% Peak Torque), Rotary Kiln.....	2.00	3.00	2.50	<b>Sugar Industry</b>						
Conveyors.....	1.25	2.25	1.75	<b>Paper Mills</b>				Mill Stands, Turbine Driven with all Helical or Herringbone Gears .....	1.50	2.50	2.00			
Maneuvering Winch, Pumps (Uniform Load), Utility Winch....	1.50	2.50	2.00	Bleachers, Coaters, Stock Pumps, Centrifugal Constant Speed.....	1.00	2.00	2.50	Cane Carrier & Leveler, Electric Drive or Steam Engine Drive with Helical Herringbone, or Spur Gears with any Prime Mover.....	1.75	2.75	2.25			
Cable Reel, Screen Drive, Stacker .....	1.75	2.75	2.25	Converting Machine, Felt Stretcher, Stock Pumps, Centrifugal Frequent Speed Changes Under Load .....	1.25	2.25	1.75	Cane Knife & Crusher.....	2.00	3.00	2.50			
Cutter Head, Jig Drive .....	2.00	3.00	2.50	Line Shaft, Reel, Rewinder, Winder, Stock Chest, Washer, Thickener .....	1.50	2.50	2.00							
<b>Food Industry</b>				Beater, Pulper, Calender,										
Bottling, Can Filling Machine .....	1.00	2.00	1.50											
Cereal Cooker.....	1.25	2.25	1.75											
Beet Slicer, Dough Mixer, Meat Grinder .....	1.75	2.75	2.25											
<b>Lumber</b>														
Rolls, Non-Reversing, Sawdust Conveyor.....	1.25	2.25	1.75											
Band Resaw, Sorting Table .....	1.50	2.50	2.00											
Circular Resaw, Cut-off, Planer, Slab Conveyor, Trimmer .....	1.75	2.75	2.25											
Edger, Head Rig, Hog, Log Haul, Rolls, Reversing .....	2.00	3.00	2.50											
Gang Saw (Reciprocating).....	Refer To Lovejoy													
<b>Metal Rolling Mills<sup>1</sup></b>														
Soaking Pit Cover Drives - Lift ....	1.00	2.00	1.50											

Notes: ■ 1 indicates: For high peak load applications, please refer to selection process on page GD-5.  
 ■ \* indicates: That Lovejoy Application Engineering should be consulted with specific requirements.  
 ■ Caution: Applications involving reciprocating engines and reciprocating driven devices are subject to critical rotational speeds which may damage the coupling and/or connected equipment. Contact Lovejoy Application Engineering with specific requirements.

**Application Service Factors**

**Chart 1, Continued**

	Electric Motor w/ Standard Torque	Reciprocating Engines-4/5 Cylinder	Reciprocating Engines-6 or more Cyl		Electric Motor w/ Standard Torque	Reciprocating Engines-4/5 Cylinder	Reciprocating Engines-6 or more Cyl		Electric Motor w/ Standard Torque	Reciprocating Engines-4/5 Cylinder	Reciprocating Engines-6 or more Cyl
<b>Textile Industry</b>				<b>Cranes, Hoist<sup>1, 2</sup></b>				Machine, Forming Mills.....	2.00	3.00	2.50
Batcher, Dyeing Machinery,				Slope.....	1.50	2.50	2.00	<b>Mixers (see Agitators)</b>			
Mangle, Napper, Soaper.....	1.25	2.25	1.75	Main or Skip Hoist, Bridge,				Muller .....	1.50	2.50	2.00
Calender, Card Machine, Cloth				Travel, Trolley <sup>2</sup> .....	1.75	2.75	2.25	Concrete .....	1.75	2.75	2.25
Finishing Machine, Dry Can,				<b>Dynamometer</b> .....	1.00	2.00	1.50	<b>Printing Press</b> .....	1.50	2.50	2.00
Loom, Spinner, Tenter Frame,				<b>Elevators<sup>2</sup></b>				<b>Pug Mill</b> .....	1.75	2.75	2.25
Winder.....	1.50	2.50	2.00	Bucket, Centrifugal, Discharge,				<b>Pulverizers</b>			
Knitting Machine.....	Refer To Lovejoy			Gravity Discharge .....	1.25	2.25	1.75	Roller.....	1.50	2.50	2.00
				Freight or Passenger.....	NOT APPROVED			Hammermill, Hog.....	1.75	2.75	2.25
<b>Applications</b>				<b>Escalators</b> .....	NOT APPROVED			<b>Pumps</b>			
<b>Aerator</b> .....	2.00	3.00	2.50	<b>Exciter, Generator</b> .....	1.00	2.00	1.50	Centrifugal Constant Speed .....	1.00	2.00	1.50
<b>Agitators</b>				<b>Extruder, Plastic</b> .....	1.50	2.50	2.00	Centrifugal Frequent Speed			
Vertical/Horizontal Screw, Pro-				<b>Fans</b>				Changes under Load, Descaling,			
peller, Paddle .....	1.00	2.00	1.50	Centrifugal, Forced Draft Motor				w/ Accumulators, Gear, Rotary,			
<b>Barge Haul Puller</b> .....	1.50	2.50	2.00	Driven thru Fluid or Electric Slip				Vane .....	1.25	2.25	1.75
<b>Blowers</b>				Clutch.....	1.00	2.00	1.50	Reciprocating, 3 or more			
Centrifugal.....	1.00	2.00	1.50	Induced Draft with Damper Con-				Cylinders .....	1.50	2.50	2.00
Lobe, Vane.....	1.25	2.25	1.75	trol or Blade Cleaner.....	1.25	2.25	1.75	Reciprocating, 2 Cyl. Double			
<b>Car Dumpers</b> .....	2.50	*	*	Forced Draft-Across the Line				Acting .....	1.75	2.75	2.25
<b>Car Pullers</b> .....	1.50	2.50	2.00	start, Gas Recirculating .....	1.50	2.50	2.00	Reciprocating, 2 Cyl. Single			
<b>Clarifier, Classifier</b> .....	1.00	2.00	1.50	Cooling Tower, Induced Draft				Acting .....	2.00	3.00	2.50
<b>Compressors</b>				without Controls .....	2.00	3.00	2.50	Reciprocating, 1 Cyl. Single/ Double Acting.....	3.00	*	*
Centrifugal, Rotary, Screw.....	1.00	2.00	1.50	<b>Feeders</b>				<b>Screens</b>			
Rotary, Lobe or Vane .....	1.25	2.25	1.75	Apron, Belt, Disc, Screw.....	1.00	2.00	1.50	Air Washing, Water .....	1.00	2.00	1.50
Reciprocating with Flywheel and				Reciprocating.....	2.50	*	*	Rotary Coal, Sand .....	1.50	2.50	2.00
Gear between Compressor and				<b>Generators</b>				Grizzly .....	2.00	3.00	2.50
Prime Mover 4 or More Cyl.				Even Load.....	1.00	2.00	1.50	Vibrating .....	2.50	*	*
Single/Double Acting.....	1.75	2.75	2.25	Hoist or Railway Service.....	1.50	2.50	2.00	<b>Ski Tows, Lifts</b> .....	NOT APPROVED		
Reciprocating with flywheel				Welder Load .....	2.00	3.00	2.50	<b>Steering Gear</b> .....	1.00	2.00	1.50
and Gear between Compressor				<b>Hammermill</b> .....	1.75	2.75	2.25	<b>Stoker</b> .....	1.00	2.00	1.50
and Prime Mover Cyl. Double				<b>Laundrywasher or Tumbler</b> .....	2.00	3.00	2.50	<b>Tumbling Barrel</b> .....	1.75	2.75	2.25
Acting .....	2.00	3.00	2.50	<b>Line Shafts</b>				<b>Winch, Maneuvering</b>			
Reciprocating with Flywheel and				Any Processing Machinery.....	1.50	2.50	2.00	Dredge, Marine.....	1.50	2.50	2.00
Gear between Compressor and				<b>Machine Tools</b>				<b>Windlass</b> .....	1.50	2.50	2.00
Prime Mover 1/2 Cyl. Single/ Double Acting and 3 cyl.				Auxiliary, Traverse Drive.....	1.00	2.00	1.50	<b>Woodworking Machinery</b> .....	1.00	2.00	1.50
Single Acting .....	3.00	*	*	Main Drive.....	1.50	2.50	2.00	<b>Work Lift Platforms</b> .....	NOT APPROVED		
Reciprocating Direct Connected, Without Flywheels.....	Refer To			Bending Roll, Notching Press, Punch Press, Planer, Plate							
Lovejoy				Reversing.....	1.75	2.75	2.25				
Conveyors <sup>2</sup>				<b>Manlifts</b> .....	NOT APPROVED						
Apron, Assembly, Belt, Chain,				<b>Metal Forming Machines</b>							
Flight, Screw .....	1.00	2.00	1.50	Slitters .....	1.00	2.00	1.50				
Bucket.....	1.25	2.25	1.75	Wire Winder, Coilers, Uncoilers... Wire Drawing, Flattening .....	1.50	2.50	2.00				
Live Roll, Shaker,				Draw Bench Carriage, Main Drive, Extruder, Forming	1.75	2.75	2.25				
Reciprocating.....	3.00	*	*								

Notes: ■ 1 indicates: For high peak load applications, please refer to selection process on page GD-5.  
 ■ 2 indicates: If people are transported Lovejoy does not recommend and will not warranty the use of the coupling.  
 ■ \* indicates: That Lovejoy Application Engineering should be consulted with specific requirements.  
 ■ Caution: Applications involving reciprocating engines and reciprocating driven devices are subject to critical rotational speeds which may damage the coupling and/or connected equipment. Contact Lovejoy Application Engineering with specific requirements.



**Grid Coupling Selection Worksheet**

Customer Name: \_\_\_\_\_ Contact Name: \_\_\_\_\_  
 Phone Number: \_\_\_\_\_ Email Address: \_\_\_\_\_

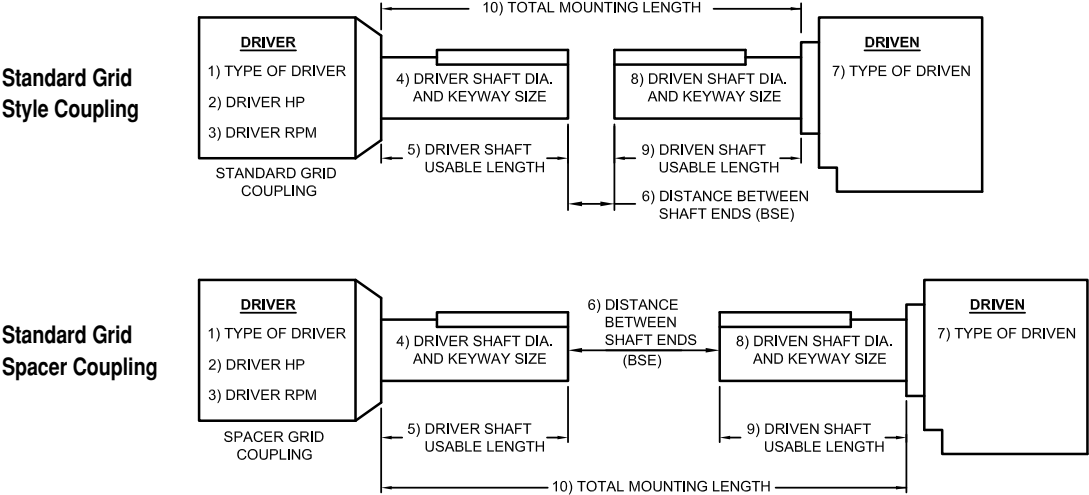

1. Type of Driver (Electric Motor, Combustion Engine, Gearbox, etc.) :  
 For combustion engines, define type  
 Gasoline, Diesel, Natural Gas, etc.: \_\_\_\_\_ Number of cylinders: \_\_\_\_\_
2. Driver Horse Power : \_\_\_\_\_ 3. Driver or Gearbox output RPM: \_\_\_\_\_  
 Retrieve the application Service Factor from Page GD-7 and GD-8 : \_\_\_\_\_ then  
 calculate the Selection Torque using the following formula:  

$$\text{Torque (in-lbs)} = \frac{\text{HP} \times 63025}{\text{RPM}} \times \text{Service Factor} = \text{Selection Torque} = \text{_____ in-lbs}$$
4. Driver Shaft Diameter : \_\_\_\_\_ Keyway size : KW Width \_\_\_\_\_ KW Height \_\_\_\_\_  
 By default, sizes 1020 thru 1090 have Clearance fits; Sizes 1100 thru 1200 have Interference Fits  
 If requesting other than default, please specify Clearance Fit, Interference Fit, Metric (P7, H7, etc)
5. Driver Usable Shaft Length : \_\_\_\_\_ (Measure from the end of the shaft to any obstruction)
6. Distance between shaft ends (BSE) : \_\_\_\_\_ (Stock BSE values can be found on page GD-14)
7. Type of Driven Equipment: \_\_\_\_\_
8. Driven Shaft Diameter : \_\_\_\_\_ Keyway size : KW Width \_\_\_\_\_ KW Height \_\_\_\_\_  
 By default, sizes 1020 thru 1090 have Clearance fits; Sizes 1100 thru 1200 have Interference Fits  
 If requesting other than default, please specify Clearance Fit, Interference Fit, Metric (P7, H7, etc)
9. Driven Usable Shaft Length : \_\_\_\_\_ (Measure from the end of the shaft to any obstruction)
10. Total Mounting Length : \_\_\_\_\_ (Advise of any obstructions, walls, beams, guards, pipes, etc.)
11. For taper bores or splines, please contact Lovejoy Application Engineering or Product Manager.

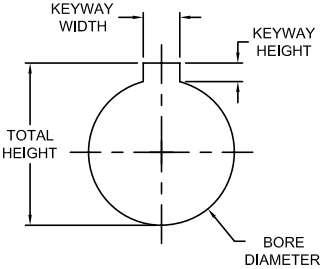

**For additional bore and keyway information, see the Engineering Data Section of the Power Transmission Products Catalog**



**Lovejoy, Inc.**  
**World Headquarters**  
 2655 Wisconsin Avenue  
 Downers Grove, IL 60515

**Send this form to:**  
 appleng@lovejoy-inc.com  
 or fax to: 800-446-0878

**Standard Grid Style Couplings  
 Horizontal and Vertical Cover**

The Lovejoy Grid coupling is an ideal coupling for applications where excellent performance is desired and additional requirements for vibration dampening may exist. The Horizontal Split Cover design is recommended in applications where there may be some constraints on the diameter of the coupling. The vertical design is recommended for applications where higher speed is one of the requirements.

**Features:**

- Designed for ease of maintenance and grid spring replacement
- High tensile grid springs ensure superior coupling performance and longer coupling life
- Split covers allow for easy access to grid springs
- Interchangeable with industry standard grid couplings



Horizontal Cover Style



Vertical Cover Style

**Grid Coupling Performance Data**

Size	Nominal Torque <sup>1</sup>		Maximum Speed		ID1 - ID2				SL <sup>2</sup>	T	Weight Solid		Moment of Inertia	
					Min Bore		Max Bore		Set Screw				Solid Hubs	
	in-lbs	Nm	Horizontal RPM	Vertical RPM	in	mm	in	mm	Location in	Size in	lbs	kg	Horizontal WR <sup>2</sup> lb-in <sup>2</sup>	Vertical WR <sup>2</sup> lb-in <sup>2</sup>
1020	460	52	4,500	6,000	0.500	12	1.125	28	0.50	#8-32	4.3	2.0	4.83	5.32
1030	1,320	149	4,500	6,000	0.500	12	1.375	35	0.31	#8-32	5.7	2.6	7.61	7.99
1040	2,200	249	4,500	6,000	0.500	12	1.625	42	0.44	#10-24	7.4	3.4	11.19	11.99
1050	3,850	435	4,500	6,000	0.500	12	1.875	48	0.62	#10-24	12.0	5.4	24.85	25.76
1060	6,050	983	4,350	6,000	0.750	19	2.125	54	0.44	#10-24	16.0	7.3	40.66	41.16
1070	8,800	994	4,125	5,500	0.750	19	2.500	64	0.88	1/4-20	23.0	10.4	63.18	61.68
1080	18,150	2 051	3,600	4,750	1.062	27	3.000	76	0.94	1/4-20	39.0	17.7	154.00	148.00
1090	33,000	3 728	3,600	4,000	1.062	27	3.500	89	1.03	5/16-18	56.0	25.4	269.00	272.00
1100	55,550	6 276	2,400	3,250	1.625	41	4.000	102	—	—	93.0	42.2	609.00	608.00
1110	82,500	9 321	2,250	3,000	1.625	41	4.500	117	—	—	120.0	54.4	923.00	930.00
1120	121,000	13 671	2,025	2,700	2.375	60	5.000	127	—	—	180.0	81.2	1,755.00	1,611.00
1130	176,000	19 884	1,800	2,400	2.625	67	6.000	152	—	—	270.0	121.0	3,375.00	3,568.00
1140	253,000	28 584	1,650	2,200	2.625	67	7.250	184	—	—	394.0	177.8	6,306.00	6,431.00
1150	352,000	39 769	1,500	—	4.250	108	8.000	200	—	—	523.0	237.2	—	—
1160	495,000	55 925	1,350	—	4.750	121	9.000	228	—	—	720.0	326.5	—	—
1170	660,000	74 567	1,225	—	5.250	134	10.000	254	—	—	1,022.5	463.7	—	—
1180	915,200	103 399	1,100	—	6.000	153	11.000	280	—	—	1,341.7	608.5	—	—
1190	1,210,000	136 706	1,050	—	6.000	153	12.000	305	—	—	1,710.0	775.5	—	—
1200	1,650,000	186 417	900	—	7.000	178	13.000	330	—	—	2,331.0	1057.1	—	—

Notes: ■ 1 Indicates: Peak torque is typically twice the Nominal Torque value.  
 ■ 2 Indicates: Sizes 1020 thru 1090 are bored with clearance fit with 2 set screws at 90°, sizes 1100 and larger are bored with interference fit and no set screw.

Grid Coupling with Horizontal Style Cover

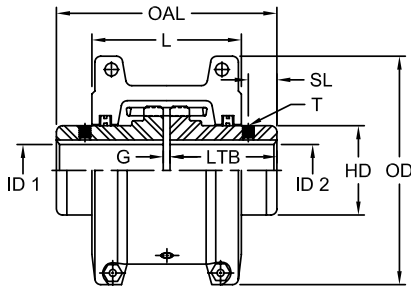

Sizes 1020 - 1140

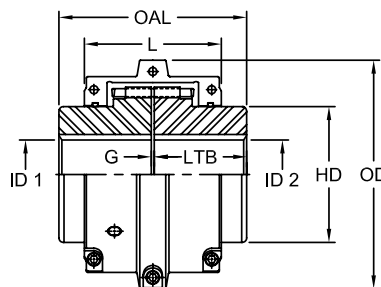

Sizes 1150 - 1200

Grid Coupling with Vertical Style Cover

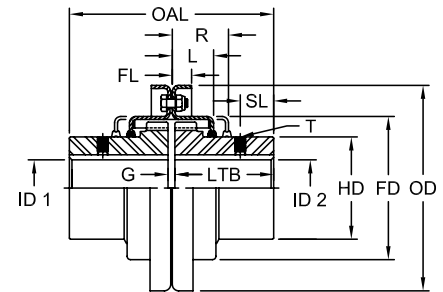

Sizes 1020 - 1090

**Grid Coupling Dimensional Data**

Size	OAL		R	L		FL	G 1		LTB		OD				FD		HD	
	in	mm		Horz Cover	Vert Cover		in	mm	in	mm	Horz Cover	Vert Cover	in	mm	in	mm	in	mm
1020	3.88	98.5	1.88	2.62	0.96	0.38	0.118	3.00	1.87	47.5	4.00	101.6	4.38	111.3	2.50	63.5	1.56	39.7
1030	3.88	98.5	1.88	2.69	1.00	0.38	0.118	3.00	1.87	47.5	4.33	110.0	4.75	120.7	2.88	73.0	1.94	49.2
1040	4.12	104.7	2.00	2.75	1.03	0.38	0.118	3.00	2.00	50.8	4.63	117.6	5.06	128.5	3.25	82.6	2.25	57.2
1050	4.88	123.8	2.38	3.18	1.24	0.47	0.118	3.00	2.37	60.3	5.43	138.0	5.81	147.6	3.88	98.4	2.63	66.7
1060	5.12	130.0	2.50	3.68	1.27	0.50	0.118	3.00	2.50	63.5	5.93	150.5	6.38	162.1	4.38	111.1	3.00	76.2
1070	6.12	155.5	2.63	3.80	1.33	0.50	0.118	3.00	3.00	76.2	6.37	161.8	6.81	173.0	4.88	123.8	3.44	87.3
1080	7.12	180.8	3.50	4.55	1.74	0.50	0.118	3.00	3.50	88.9	7.64	194.0	7.13	181.1	5.00	127.0	4.13	104.9
1090	7.88	200.0	3.75	4.80	1.86	0.50	0.118	3.00	3.87	98.4	8.39	213.0	7.88	200.2	5.88	149.2	4.87	123.7
1100	9.69	246.1	4.75	6.12	2.38	0.63	0.177	4.50	4.75	120.6	9.84	250.0	9.69	246.1	7.75	196.9	5.59	142.0
1110	10.19	258.7	4.88	6.36	2.50	0.63	0.177	4.50	5.00	127.0	10.63	270.0	11.25	285.8	8.50	215.9	6.31	160.3
1120	12.00	304.8	5.63	7.54	2.94	0.68	0.236	6.00	5.87	149.2	12.13	308.0	12.56	319.0	9.63	244.5	7.06	179.4
1130	13.00	330.2	5.75	7.68	3.00	0.82	0.236	6.00	6.37	161.9	13.62	346.0	14.88	378.0	11.13	282.6	8.56	217.5
1140	14.63	371.6	6.13	7.91	3.13	0.82	0.236	6.00	7.20	182.9	15.12	384.0	16.38	416.1	12.63	320.7	10.00	254.0
1150	14.65	372.1	—	10.69	—	—	0.236	6.00	7.20	182.9	17.84	453.1	—	—	—	—	10.60	269.2
1160	15.85	402.6	—	10.96	—	—	0.236	6.00	7.80	198.1	19.74	501.4	—	—	—	—	12.00	304.8
1170	17.25	437.1	—	12.10	—	—	0.236	6.00	8.50	215.9	22.30	566.4	—	—	—	—	14.00	355.6
1180	19.05	483.9	—	12.64	—	—	0.236	6.00	9.40	238.8	24.80	629.9	—	—	—	—	15.50	393.7
1190	20.65	524.5	—	12.80	—	—	0.236	6.00	10.20	259.1	26.60	675.6	—	—	—	—	17.20	436.9
1200	22.25	565.1	—	14.00	—	—	0.236	6.00	10.98	279.0	29.80	756.9	—	—	—	—	19.60	497.8

Note: ■ 1 indicates: For sizes 1020 thru 1080, the gap tolerance for dimension G is + .050" / - .050" (+ 1.5 mm / - 1.5 mm).  
 For sizes 1090 thru 1120, the gap tolerance for dimension G is + .177" / - .118" (+ 4.5 mm / - 3 mm).  
 For sizes 1120 thru 1200, the gap tolerance for dimension G is + .236" / - .177" (+ 6 mm / - 4.5 mm).

**Standard Grid Spacer and Half Spacer Style Couplings**  
**Horizontal Cover**

The Lovejoy Grid Spacer coupling is an ideal coupling for applications where there is a requirement for some vibration dampening in installations that are not close coupled. This means some amount of gap, or BSE exists between the driver and driven equipment shafts.

All Lovejoy Grid Spacer Couplings are supplied with Horizontal Split Covers. The split cover design allows for quick access to the grid spring for ease of maintenance or grid spring replacement. The Horizontal Split Cover is also ideal for applications where there may be some constraints on the diameter of the coupling.

**Features:**

- Designed for ease of maintenance and grid spring replacement
- High tensile grid springs ensure superior coupling performance and longer coupling life
- Split covers allow for easy access to grid springs
- Interchangeable with industry standard grid couplings



Full Spacer Style



Half Spacer Style

GD

**Grid Series Spacer Coupling Performance and Dimensional Data**

Size	Nominal Torque <sup>1</sup>		Maximum Speed RPM	ID1 - ID2			G in	G1 in	LTB		FD in	HD in	OD in	SL	T
	in-lbs	Nm		Min Bore in/mm	Max Bore in mm	Std Hub in mm			Set Screw						
									Location in	Size in					
1020	460	48	3,600	Solid	1.38	35	0.19	0.03	1.87	47	3.38	2.06	4.00	0.50	#8-32
1030	1,320	136	3,600	Solid	1.63	41	0.19	0.03	1.87	47	3.69	2.34	4.38	0.31	#8-32
1040	2,200	226	3,600	Solid	2.13	54	0.19	0.03	2.00	51	4.44	3.09	4.62	0.44	#10-24
1050	3,850	395	3,600	Solid	2.38	60	0.19	0.03	2.37	60	4.94	3.44	5.44	0.62	#10-24
1060	6,050	621	3,600	Solid	2.88	73	0.19	0.06	2.50	64	5.69	4.06	5.94	0.44	#10-24
1070	8,800	904	3,600	Solid	3.13	79	0.19	0.06	3.00	76	6.00	4.31	6.38	0.88	1/4-20
1080	18,150	1 864	3,600	Solid	3.50	89	0.19	0.06	3.50	89	7.00	4.81	7.62	0.94	1/4-20
1090	33,000	3 390	3,600	Solid	4.00	102	0.19	0.06	3.87	98	8.25	5.62	8.38	1.03	5/16-18

Note: ■ 1 Indicates: Peak torque is typically twice the Nominal Torque value.

To calculate the OAL (Over All Length) for Full Spacer Style (Spacer Hubs both ends) use the following formula: $OAL = (2 \times LTB) + (2 \times S) + (2 \times G1) + G$
To calculate the OAL (Over All Length) for Half Spacer Style (Spacer Hubs one end only) use the following formula: $OAL = LTB + LTB2 + S + G1 + G$

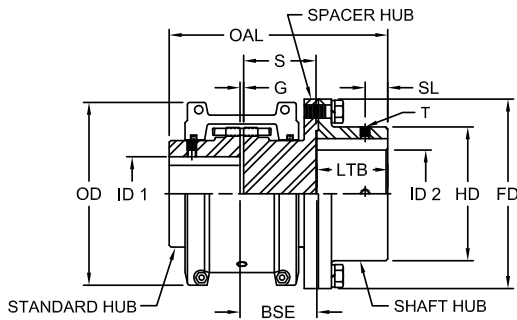

**Half Spacer Style Grid Coupling**

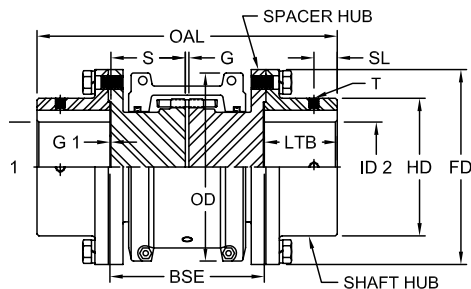

**Full Spacer Style Grid Coupling**

Each column has a header showing the desired shaft separation (BSE). By extending the coupling size over to the desired column for the shaft separation, the box lists the two hub sizes required to achieve the BSE.

**Grid Series Half Spacer Dimensional Data**

Size	Spacer Hubs	BSE - Application Shaft Separation				
		1.781	2.219	2.531	3.500	3.656
1-side only		Spacer Hub Lengths S-Dimension				
1020	Std Hub	Std	Std	Std	—	—
	Hub 2	1.625	2.062	2.375	—	—
1030	Std Hub	Std	Std	Std	Std	Std
	Hub 2	1.625	2.062	2.375	3.344	3.500
1040	Std Hub	Std	Std	Std	Std	Std
	Hub 2	1.625	2.062	2.375	3.344	3.500
1050	Std Hub	—	—	Std	—	Std
	Hub 2	—	—	2.375	—	3.500
1060	Std Hub	—	—	Std	—	Std
	Hub 2	—	—	2.344	—	3.469
1070	Std Hub	—	—	Std	—	Std
	Hub 2	—	—	2.344	—	3.469
1080	Std Hub	—	—	—	—	Std
	Hub 2	—	—	—	—	3.469
1090	Std Hub	—	—	—	—	Std
	Hub 2	—	—	—	—	3.469

GD

**Grid Series Full Spacer Dimensional Data**

Size	Spacer Hubs	BSE - Application Shaft Separation														
		3.500	3.980	4.250	4.375	4.688	5.000	5.219	5.375	5.656	5.813	5.969	6.125	6.938	7.094	7.250
Both Hubs		Spacer Hub Lengths S - Dimension (See drawing above)														
1020	Hub 1	1.625	1.625	1.625	2.062	2.062	2.375	—	—	—	—	—	—	—	—	—
	Hub 2	1.625	2.062	2.375	2.062	2.375	2.375	—	—	—	—	—	—	—	—	—
1030	Hub 1	1.625	1.625	1.625	2.062	2.062	2.375	—	1.625	—	2.062	2.375	2.375	—	—	3.500
	Hub 2	1.625	2.062	2.375	2.062	2.375	2.375	—	3.500	—	3.500	3.344	3.500	—	—	3.500
1040	Hub 1	1.625	1.625	1.625	2.062	2.062	2.375	1.625	1.625	2.062	2.062	2.375	2.375	3.344	3.344	3.500
	Hub 2	1.625	2.062	2.375	2.062	2.375	2.375	3.344	3.500	3.344	3.500	3.344	3.500	3.344	3.500	3.500
1050	Hub 1	—	—	—	2.062	2.062	2.375	—	—	2.062	2.062	—	2.375	3.344	3.344	3.500
	Hub 2	—	—	—	2.062	2.375	2.375	—	—	3.344	3.500	—	3.500	3.344	3.500	3.500
1060	Hub 1	—	—	—	—	—	2.344	—	—	—	—	—	—	—	—	3.469
	Hub 2	—	—	—	—	—	2.344	—	—	—	—	—	3.469	—	—	3.469
1070	Hub 1	—	—	—	—	—	2.344	—	—	—	—	—	—	—	—	3.469
	Hub 2	—	—	—	—	—	2.344	—	—	—	—	—	3.469	—	—	3.469
1080	Hub 1	—	—	—	—	—	—	—	—	—	—	—	—	—	—	3.469
	Hub 2	—	—	—	—	—	—	—	—	—	—	—	—	—	—	3.469
1090	Hub 1	—	—	—	—	—	—	—	—	—	—	—	—	—	—	3.469
	Hub 2	—	—	—	—	—	—	—	—	—	—	—	—	—	—	3.469

**Grid Series Misalignment Capacity (Standard and Spacer Type)**

Size	P	X - Y	P	X-Y	G
	Maximum Misalignment				Nominal BSE - Gap
	Installation		Operational		
	Parallel in	Angular 1 in	Parallel in	Angular 1 in	+/- 10% in
1020	0.006	0.002	0.012	0.009	0.118
1030	0.006	0.003	0.012	0.011	0.118
1040	0.006	0.003	0.012	0.013	0.118
1050	0.008	0.004	0.016	0.015	0.118
1060	0.008	0.004	0.016	0.018	0.118
1070	0.008	0.005	0.016	0.020	0.118
1080	0.008	0.006	0.016	0.024	0.118
1090	0.008	0.007	0.016	0.028	0.118
1100	0.010	0.008	0.020	0.032	0.177
1110	0.010	0.009	0.020	0.035	0.177
1120	0.011	0.010	0.022	0.040	0.236
1130	0.011	0.012	0.022	0.047	0.236
1140	0.011	0.013	0.022	0.053	0.236
1150	0.012	0.015	0.024	0.061	0.236
1160	0.012	0.017	0.024	0.070	0.236
1170	0.012	0.020	0.024	0.079	0.236
1180	0.015	0.022	0.030	0.089	0.236
1190	0.015	0.024	0.030	0.096	0.236
1200	0.015	0.027	0.030	0.107	0.236

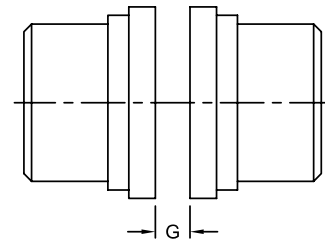

Normal Gap

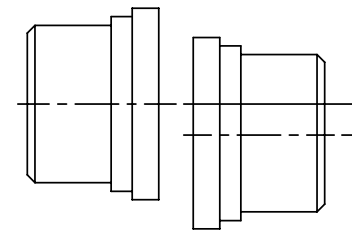

Parallel Misalignment

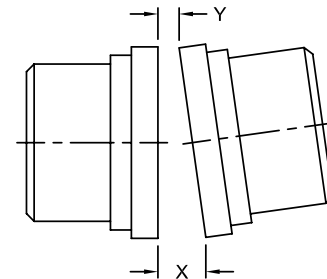

Angular Misalignment

Note: ■ 1 Indicates: Allowable angular misalignment at installation is 1/16°. Allowable angular misalignment during operation is 1/4°.

**Misalignment Capability:**

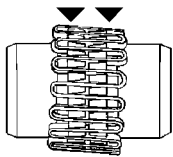

**Parallel:** The movement of the grid in the hub grooves accommodates parallel misalignment and still permits full functioning of the grid-groove action in damping out shock and vibration.

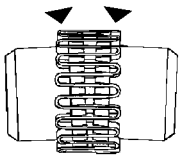

**Angular:** Under angular misalignment, the grid-groove design permits a rocking and sliding action of the grid and hubs without any loss of power through the resilient grid.

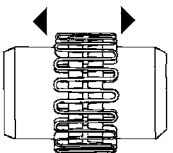

**Axial:** End float is permitted for both driving and driven members because the grid slides freely in the grooves.



# Industry Standard Interchange Chart Item Selection

## Industry Standard Interchange

Lovejoy Grid couplings are interchangeable with industry standard grid couplings supplied by other major coupling manufacturers. The chart below provides part numbers necessary to make the crossover from these other major manufacturers.

### Industry Standard Grid Coupling Interchange Chart

Lovejoy® Size	Horizontal — Split Cover				Vertical — Split Cover			
	Falk® Steelflex®	Morse/Browning® Grid-Flex®	Dodge® Grid-Lign®	Kop-Flex® Kop-Grid®	Falk® Steelflex®	Morse/Browning® Grid-Flex®	Dodge® Grid-Lign®	Kop-Flex® Kop-Grid®
1020	1020T10	GF2020H	1020T10	1020H	1020T20	GF2020V	1020T20	1020V
1030	1030T10	GF2030H	1030T10	1030H	1030T20	GF2030V	1030T20	1030V
1040	1040T10	GF2040H	1040T10	1040H	1040T20	GF2040V	1040T20	1040V
1050	1050T10	GF2050H	1050T10	1050H	1050T20	GF2050V	1050T20	1050V
1060	1060T10	GF2060H	1060T10	1060H	1060T20	GF2060V	1060T20	1060V
1070	1070T10	GF2070H	1070T10	1070H	1070T20	GF2070V	1070T20	1070V
1080	1080T10	GF2080H	1080T10	1080H	1080T20	GF2080V	1080T20	1080V
1090	1090T10	GF2090H	1090T10	1090H	1090T20	GF2090V	1090T20	1090V
1100	1100T10	GF2100H	1100T10	1100H	1100T20	GF2100V	1100T20	1100V
1110	1110T10	GF2110H	1110T10	1110H	1110T20	GF2110V	1110T20	1110V
1120	1120T10	GF2120H	1120T10	1120H	1120T20	GF2120V	1120T20	1120V
1130	1130T10	GF2130H	1130T10	1130H	1130T20	GF2130V	1130T20	1130V
1140	1140T10	GF2140H	1140T10	1140H	1140T20	GF2140V	1140T20	1140V
1150	1150T10	—	—	—	—	—	—	—
1160	1160T10	—	—	—	—	—	—	—
1170	1170T10	—	—	—	—	—	—	—
1180	1180T10	—	—	—	—	—	—	—
1190	1190T10	—	—	—	—	—	—	—
1200	1200T10	—	—	—	—	—	—	—

GD



# Grid Coupling Hubs – Inch Bore / Keyway Item Selection

**Grid Coupling Hubs - Inch Bore and Keyway UPC Number Selection Table**

Bore	Keyway	1020	1030	1040	1050	1060	1070	1080	1090	1100	1110	1120	1130	1140
<b>SOLID</b>		05231	05232	05233	05234	05235	05236	05237	05238	05239	05240	05241	05242	05243
1/2	1/8 x 1/16	05458	—	—	—	—	—	—	—	—	—	—	—	—
5/8	3/16 x 3/32	05459	05464	—	—	—	—	—	—	—	—	—	—	—
3/4	3/16 x 3/32	05460	05465	06140	—	—	—	—	—	—	—	—	—	—
7/8	3/16 x 3/32	05461	05466	05471	06141	06142	99245	—	—	—	—	—	—	—
15/16	1/4 x 1/8	06100	06101	06103	06106	16752	—	—	—	—	—	—	—	—
1	1/4 x 1/8	05462	05467	05472	06107	06112	90793	—	—	—	—	—	—	—
1-1/8	1/4 x 1/8	05463	05468	05473	05478	06113	06144	07364	—	—	—	—	—	—
1-3/16	1/4 x 1/8	—	06102	06104	06108	06114	—	—	—	—	—	—	—	—
1-1/4	1/4 x 1/8	—	05469	05474	05479	06115	06145	06148	—	—	—	—	—	—
1-3/8	5/16 x 5/32	—	05470	05475	05480	05485	06119	06149	—	—	—	—	—	—
1-7/16	3/8 x 3/16	—	—	06105	06109	06116	06120	08124	—	—	—	—	—	—
1-1/2	3/8 x 3/16	—	—	05476	05481	05486	06121	91199	—	—	—	—	—	—
1-5/8	3/8 x 3/16	—	—	05477	05482	05487	05492	06150	—	—	—	—	—	—
1-11/16	3/8 x 3/16	—	—	—	06110	06117	06122	97351	—	—	—	—	—	—
1-3/4	3/8 x 3/16	—	—	—	05483	05488	05493	06124	94087	—	—	—	—	—
1-13/16	1/2 x 1/4	—	—	—	06111	06118	06123	06125	—	—	—	—	—	—
1-7/8	1/2 x 1/4	—	—	—	05484	05489	05494	06126	06154	—	—	—	—	—
1-15/16	1/2 x 1/4	—	—	—	—	06143	06146	06151	16852	—	—	—	—	—
2	1/2 x 1/4	—	—	—	—	05490	05495	05500	06155	—	—	—	—	—
2-1/8	1/2 x 1/4	—	—	—	—	05491	05496	05501	06127	—	—	—	—	—
2-3/16	1/2 x 1/4	—	—	—	—	—	06147	06152	06156	—	—	—	—	—
2-1/4	1/2 x 1/4	—	—	—	—	—	05497	05502	06128	11767	—	—	—	—
2-3/8	5/8 x 5/16	—	—	—	—	—	05498	05503	06129	09399	—	—	—	—
2-1/2	5/8 x 5/16	—	—	—	—	—	05499	05504	05509	05519	—	—	—	—
2-5/8	5/8 x 5/16	—	—	—	—	—	—	05505	05510	05520	—	—	—	—
2-3/4	5/8 x 5/16	—	—	—	—	—	—	05506	05511	05521	—	—	—	—
2-7/8	3/4 x 3/8	—	—	—	—	—	—	05507	05512	05522	—	—	—	—
2-15/16	3/4 x 3/8	—	—	—	—	—	—	06153	04386	—	—	—	—	—
3	3/4 x 3/8	—	—	—	—	—	—	05508	05513	05523	05532	05542	—	—
3-1/8	3/4 x 3/8	—	—	—	—	—	—	—	05514	05524	05533	05543	—	—
3-1/4	3/4 x 3/8	—	—	—	—	—	—	—	05515	05525	05534	05544	—	—
3-3/8	7/8 x 7/16	—	—	—	—	—	—	—	05516	05526	05535	05545	—	—
3-7/16	7/8 x 7/16	—	—	—	—	—	—	—	06158	95492	—	—	—	—
3-1/2	7/8 x 7/16	—	—	—	—	—	—	—	05517	05527	05536	05546	05553	—
3-5/8	7/8 x 7/16	—	—	—	—	—	—	—	—	05528	05537	05547	05554	—
3-3/4	7/8 x 7/16	—	—	—	—	—	—	—	—	05529	05538	05548	05555	—
3-7/8	1 x 1/2	—	—	—	—	—	—	—	—	05530	05539	05549	05556	05562
4	1 x 1/2	—	—	—	—	—	—	—	—	05531	05540	05550	05557	05563
4-1/2	1 x 1/2	—	—	—	—	—	—	—	—	—	05541	05551	05558	05564
5	1 1/4 x 5/8	—	—	—	—	—	—	—	—	—	—	05552	05559	05565
5-1/2	1 1/4 x 5/8	—	—	—	—	—	—	—	—	—	—	—	05560	05566
6	1 1/2 x 3/4	—	—	—	—	—	—	—	—	—	—	—	05561	05567
6-1/2	1 1/2 x 3/4	—	—	—	—	—	—	—	—	—	—	—	—	05568
7	1 1/2 x 3/4	—	—	—	—	—	—	—	—	—	—	—	—	05569

- Notes:
- Size 1020 thru 1090 hubs are provided with clearance fit bores and 2 set screws at 90°.
  - Size 1100 thru 1200 hubs are provided with interference fit bores and no set screws.
  - Lovejoy machines Inch bores and keyways to meet tolerances define in the ANSI/AGMA 9002-B04 Standard.
  - When referencing the Lovejoy UPC number from this table, include 697904 as a prefix to the number shown.





# Grid Coupling Hubs – Metric Bore / Keyway Item Selection

**Grid Coupling Hubs - Metric Bore and Keyway UPC Number Selection Table**

Bore	Keyway	1020	1030	1040	1050	1060	1070	1080	1090
14	5 x 2.3	05780	—	—	—	—	—	—	—
15	5 x 2.3	05781	—	—	—	—	—	—	—
16	5 x 2.3	05782	07703	—	—	—	—	—	—
19	6 x 2.8	05783	05788	—	—	—	—	—	—
20	6 x 2.8	05784	05789	90454	—	—	—	—	—
22	6 x 2.8	05785	05790	93740	—	—	—	—	—
24	8 x 3.3	05786	05791	05797	19975	—	—	—	—
25	8 x 3.3	05787	05792	05798	16296	—	—	—	—
28	8 x 3.3	—	05793	05799	05805	—	—	—	—
30	8 x 3.3	—	05794	05800	05806	—	—	—	—
32	10 x 3.3	—	05795	05801	05807	11865	—	—	—
35	10 x 3.3	—	05796	05802	05808	05812	05817	—	—
38	10 x 3.3	—	—	05803	05809	05813	05818	05823	—
42	12 x 3.3	—	—	05804	05810	05814	05819	05824	05830
48	14 x 3.8	—	—	—	05811	05815	05820	05825	05831
55	16 x 4.3	—	—	—	—	05816	05821	05826	05832
60	18 x 4.4	—	—	—	—	—	05822	05827	05833
70	20 x 4.9	—	—	—	—	—	—	05828	05834
80	22 x 5.4	—	—	—	—	—	—	05829	05835
85	22 x 5.4	—	—	—	—	—	—	—	05836
95	22 x 5.4	—	—	—	—	—	—	—	05837

- Notes:
- Size 1020 thru 1090 hubs are provided with clearance fit bores and 2 set screws at 90°.
  - Lovejoy machines Metric bores and keyways to meet tolerances defined in the ISO 286-2 Standard.
  - When referencing the Lovejoy UPC number in this table, include 697904 as a prefix to the number shown.



# Grid Coupling – Taper Lock Hubs Item Selection

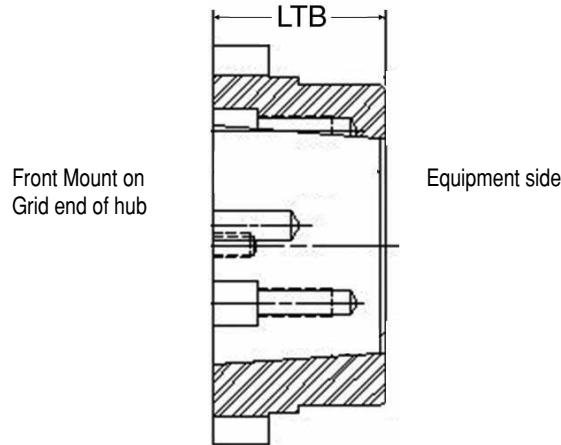

**Taper Lock Bushing Hub Torque Ratings and UPC Number Selection Table**

Grid Coupling Size	Taper-Lock Bushing	Max Bore <sup>1</sup> Bushing in	Max Torque Bushing in-lbs	Rated Torque Coupling in-lbs	LTB		Hub UPC Numbers	
					in	mm	UNC <sup>2</sup> Thread	BSW <sup>2</sup> Thread
1030	1108	1.125	1,300	1,320	1.625	41.3	06841	06851
1040	1108	1.125	1,300	2,200	1.625	41.3	06842	06852
1050	1215	1.250	3,550	3,850	1.875	47.6	06843	06853
1060	1615	1.625	4,300	6,050	2.125	54.0	06844	06854
1070	2012	2.000	7,150	8,800	2.125	54.0	06845	06855
1080	2525	2.500	11,300	18,150	2.625	66.7	06846	06856
1090	3030	3.000	24,000	33,000	3.110	79.0	06847	06857
1100	3030	3.000	24,000	55,550	3.490	88.6	06848	06858
1110	3535	3.500	44,800	82,500	3.625	92.0	06849	06859
1120	4040	4.000	77,300	121,000	4.375	111.1	06850	06860
1130	4545	4.500	110,000	176,000	4.625	—	18296	—

- Notes:
- 1 Indicates: The maximum bore is supplied with a standard ANSI/AGMA 9002-B04 or ISO 286-2 keyway.
  - 2 Indicates: Taper Lock Bushing mounting screws can be either inch (UNC) or metric (BSW) and care should be taken to select the proper hub part number.
  - Taper Lock Bushings are a product of Baldor Dodge and are not included with Lovejoy coupling hubs.
  - Maximum bore size and torque capacities are per Dodge specifications and Lovejoy is not responsible for the accuracy of any of the values listed relative to bore size and torque capacity.
  - When referencing the Lovejoy UPC number in this table, indicate 697904 as prefix to number shown.



# Grid Coupling – Component Part Numbers Item Selection

## Tapered Component UPC Number Selection Table

Sizes →	1020	1030	1040	1050	1060	1070	1080	1090	1100	1110	1120	1130	1140
Grid Only	05244	05245	05246	05247	05248	05249	05250	05251	05252	05253	05254	05255	05256
<b>Horizontal Design:</b>													
Cover/Grid Assembly-Metric	05366	05367	05368	05369	05370	05371	05372	05373	05374	05375	05376	05377	05378
Cover/Grid Assembly-Inch	05349	05350	05351	05352	05353	05354	05355	05356	05357	05358	05359	05360	05361
Cover Set-Metric	05290	05291	05292	05293	05294	05295	05296	05297	05298	05299	05300	05301	05302
Cover Set-Inch	05273	05274	05275	05276	05277	05278	05279	05280	05281	05282	05283	05284	05285
Seal Kit	05176	05177	05178	05179	05180	05181	05182	05183	05184	05185	05186	05187	05188
Cover Hardware-Metric	05210	05210	05210	05211	05211	05212	05212	05212	05213	05213	05214	05214	05214
Cover Hardware-Inch	05433	05433	05433	05434	05434	05435	05435	05435	05436	05436	05437	05437	05437
<b>Vertical Design:</b>													
Cover/Grid Assembly-Metric	05400	05401	05402	05403	05404	05405	05406	05407	05408	05409	05410	05411	05412
Cover/Grid Assembly-Inch	05383	05384	05385	05386	05387	05388	05389	05390	05391	05392	05393	05394	05395
Cover Set-Metric	05328	05329	05330	05331	05332	05333	05334	05335	05336	05337	05338	05339	05340
Cover Set-Inch	05307	05308	05309	05310	05311	05312	05313	05314	05315	05316	05317	05318	05319
Seal Kit	05189	05190	05191	05192	05193	05194	05195	05196	05197	05198	05199	05200	05201
Cover Hardware-Metric	05215	05216	05216	05217	05217	05217	05218	05218	05219	05219	05220	05221	05222
Cover Hardware-Inch	05442	05443	05443	05444	05444	05444	05445	05445	05446	05446	05447	05448	05449

- Notes:
- The "Cover/Grid Assembly" includes ALL components of the coupling except the hubs and spacers.
  - The terms "Inch" and "Metric" refer to the hardware (bolts, etc.).
  - The "Cover Set" contains the parts of the Cover/Grid Assembly without the grid spring.
  - The "Seal Kit" contains the rubber seals, gasket(s), and lube plugs.
  - "Cover Hardware" includes the fasteners that hold the cover together.
  - Grease packets are included with all Cover Sets and Cover/Grid Assemblies thru coupling size 1090.
  - When referencing the Lovejoy UPC number in this table, include 697904 as a prefix to the number shown.

## Straight Component UPC Number Selection Table

Sizes →	1150	1160	1170	1180	1190	1200
<b>Horizontal Design:</b>						
Hub 73mm RSB	05587	—	—	—	—	—
Hub 100mm RSB	—	05589	05591	—	—	—
Hub 125mm RSB	—	—	—	05593	—	—
Hub 152mm RSB	—	—	—	—	99508	—
Hub 178mm RSB	—	—	—	—	—	99257
Grid Only	05257	05258	05329	05260	99254	99255
Cover/Grid Assembly-Metric	05379	05380	05381	05382	99270	10953
Cover/Grid Assembly-Inch	05362	05363	05364	05365	10555	10559
Cover Set-Metric	05303	05304	05305	05306	99271	10951
Cover Set-Inch	05286	05287	05288	05289	10556	10560
Seal Kit	05425	05426	05427	05428	10557	10561
Cover Hardware-Metric	05429	05429	05430	05430	—	—
Cover Hardware-Inch	05438	05438	05439	05439	10558	10562

- Notes:
- The "Cover/Grid Assembly" includes ALL components of the coupling except the hubs and spacers.
  - The terms "Inch" and "Metric" refer to the hardware (bolts, etc.).
  - The "Cover Set" contains the parts of the Cover/Grid Assembly without the grid spring.
  - The "Seal Kit" contains the rubber seals, gasket(s), and lube plugs.
  - "Cover Hardware" includes the fasteners that hold the cover together.
  - When referencing the Lovejoy UPC number in this table, include 697904 as a prefix to the number shown.