

TIMKEN



TIMKEN® THRUST BEARING CATALOG



THRUST BEARING CATALOG INDEX

| | |
|--|----|
| TIMKEN OVERVIEW | 2 |
| PRODUCTS AND SERVICES | 5 |
| HOW TO USE THIS CATALOG | 9 |
| SHELF LIFE AND STORAGE | 10 |
| WARNINGS AND CAUTIONS | 12 |
| ENGINEERING | 13 |
| Thrust Bearing Types | 14 |
| Bearing Reactions | 20 |
| Bearing Ratings | 22 |
| System Life and Weighted Average Load and Life | 28 |
| Bearing Tolerances, Metric and Inch Systems | 29 |
| Mounting Design, Fitting Practice and Setting | 37 |
| Bearing Operation | 51 |
| Lubrication | 55 |
| PRODUCT DATA TABLES | 65 |
| Nomenclature | 66 |
| Angular Contact Thrust Ball Bearings | 69 |
| Thrust Cylindrical Roller Bearings | 75 |
| Thrust Spherical Roller Bearings | 85 |
| Thrust Tapered Roller Bearings | 93 |



GROW STRONGER WITH TIMKEN

Every day, people around the world count on the strength of Timken. Our expertise in metallurgy, friction management and mechanical power transmission helps them accelerate improvements in productivity and uptime.

We supply products and services that can help keep your operations moving forward, whether you need drive train kits for commercial vehicles, durable housings for bearings in dirty environments, couplings that avoid metal-to-metal contact between motors and gearboxes, repair services for bearings and gearboxes, roller chain for dry, abrasive and high-moisture applications, or other products and services for your applications.

When you choose Timken, you receive more than high-quality products and services: you gain a worldwide team of highly trained and experienced Timken people committed to working collaboratively with you to improve your business.

Globally, our 17,000 people provide reliable answers for a wide range of operations in manufacturing, mining, medical equipment, aerospace, transportation, oil and gas – and other diverse industries.



INCREASE YOUR EQUIPMENT UPTIME

In addition to high-quality bearings and mechanical power transmission components, we provide valuable integrated products and services. For example, we offer repair services and monitoring equipment that can alert you to problems before they impact your uptime.

Additionally, we offer a broad selection of seals, premium lubricants, lubricators, couplings and chain to keep your operations moving smoothly.

Our 12 technology centers in the United States, Europe and Asia help pioneer tomorrow's innovations with extensive basic and applied scientific research programs. Through internal development and strategic acquisition of innovative companies, we continue to expand our portfolio of highly engineered bearings, power transmission products and advanced services.



INDUSTRIAL INNOVATOR

Today, manufacturing and processing equipment handle heavier loads, faster speeds and greater expectations than ever before. As finished-product quality requirements increase, producers continue to place a very high premium on equipment uptime and performance.

Timken has more than a century of experience developing bearings and related solutions that help equipment run more efficiently in a wide range of applications. As the leader in friction-management and power-transmission solutions for industrial markets, Timken helps operators improve their equipment's performance and uptime. We accomplish this by providing custom solutions – from bearings that stand-up to the harshest environments to condition monitoring that minimizes maintenance costs and improves plant productivity.

INNOVATION AND CUSTOMER SUPPORT

Timken operates technology centers around the world dedicated to developing innovative concepts and products that help you operate more efficiently. Our technical leadership and customer support reach far beyond our products. Timken customers have access to sales and service engineering support at their plants, and options for additional support from application engineers who specialize in a variety of industrial applications.



CORE CAPABILITIES

Timken has evolved from its early roots as a bearing producer to a supplier offering much more, including friction-management and power-transmission solutions that add value throughout the complete life cycle of a system. Our material

enhancements improve bearing life and can protect against debris and corrosion – two challenges encountered frequently in various industrial applications. Our precision manufacturing capabilities and commitment to quality ensure global consistency in design and manufacturing at every Timken facility. A global distribution network provides our customers with easy access to Timken products and services throughout the world.

We leverage these core capabilities as we work with original equipment manufacturers (OEM) and designers to integrate our technologies into equipment so that end users can enjoy the performance benefits of Timken products from the first day of operation. OEMs depend on Timken for our engineering expertise, manufacturing capabilities and emphasis on reliable performance.



PRODUCTS AND SERVICES

We offer equipment builders and operators one of the most extensive friction-management product and service portfolios in the industry.

We also strictly adhere to the Timken Quality Management System in every plant worldwide, so each bearing product meets the same high quality standards – no matter where in the world it is manufactured.

BEARINGS

Timken provides a broad range of bearing designs and configurations for use in steelmaking vessels, caster segments, work rolls, backup rolls, screwdown systems, mill drives, pinion stands, coilers, table rolls, and auxiliary equipment. Bearing types include:

- **Tapered roller bearings** – Tapered roller bearings are uniquely designed to manage both thrust and radial loads and are available in single- and multi-row designs with a wide range of assembly options. Our extensive offering of tapered roller bearing combinations provides equipment builders and operators simple, reliable and less costly design solutions.
- **Cylindrical roller bearings** – This design generally offers the highest possible radial load capacity for a given size compared to other roller bearing types. Single-row and double-row cylindrical roller bearings are ideal for many mill stand, gear drive and other auxiliary equipment applications, while four-row cylindrical roller bearings are used in roll neck applications. Timken offers both single and multi-row cylindrical roller bearing. Custom designs are available upon request for specific applications.
- **Spherical roller bearings** – Spherical roller bearings offer high radial and moderate thrust capacity together with maximum static and dynamic misalignment capability. Timken® spherical roller bearings provide high-static load

capacity and advanced geometry that reduces friction and heat generation. These bearings are available in a range of dimensional stability configurations to suit elevated operating temperatures.

- **Thrust roller bearings** – Thrust roller bearings for rolling mill applications are available in cylindrical, spherical and tapered designs. Thrust bearings are ideal for applications experiencing heavy axial loads, such as mill stands, screw-down systems and piercing mills.



- **Ball bearings** - Ball bearings are used extensively in auxiliary applications that have light loads and/or high-speed conditions. Timken offers a range of radial, thrust and angular contact ball bearings in both metric and inch sizes. Please contact your Timken engineer for detailed information on these product ranges.
- **Housed units** - Timken® spherical roller bearing solid-block housed units process a unique cast-steel design that handles demanding conditions in metal industry applications. These solid-block housed units come in several styles and five advanced locking configurations. Timken spherical roller bearing solid-block housed units are designed for challenging circumstances. A full line of primary seals, covers and housings is available to find the right roller housed unit to fit your application. In case of high thrust loads, in excess of the spherical roller bearing carrying capabilities, the Timken® Type E is your recommended solution. Through our unique product design, we have optimized the core components so their performance is elevated to a level we consider the next generation of roller housed units. Application testing has shown that our Type E bearing yields a design life that is 55 percent higher than current industry leading designs which utilize standard Timken bearings. Timken also provides a broad range of SNT metric plummer blocks and the SAF inch pillow block line which include a wide range of sizes, housing designs, seals and accessories. The standard line of Timken split-block housings is constructed of cast iron and designed to protect bearings.

HIGH-PERFORMANCE BEARING SOLUTIONS

Timken provides a variety of high-performance bearing solutions, including Timken® AquaSpexx®, DuraSpexx® and thin dense chrome bearings for corrosion protection. Our debris-resistant bearings are ideal for contaminated and/or marginal lubrication conditions.

We also provide customized bearing solutions such as special race profiles to meet special application requirements.

In addition to component geometry and metallurgy, we find many ways to enhance bearing performance by applying unique surface finishes and special coatings on rollers, raceways and other functional surfaces. Engineered surfaces and topographical modifications reduce surface roughness to lower levels rather than what can be achieved through conventional grinding and honing methods. We also offer proprietary coatings that can create a surface up to four times harder than steel with twice the elasticity. For more information on Timken high-performance bearings and engineered surfaces, contact a Timken sales representative.



POWER TRANSMISSION COMPONENTS AND SYSTEMS

Timken offers an expanding range of power transmission components including seals, couplings and engineered chain.

Extreme temperatures and high contamination levels can disable your equipment and significantly lower productivity. Timken develops seals using advanced material and process solutions that help protect machinery and minimize plant downtime. We offer a comprehensive line of large-bore oil and grease seals, and metallic and non-metallic bearing isolators.

Timken® Quick-Flex® couplings are highly durable, yet need minimal maintenance. They are easy to install and require no lubrication. The couplings are designed to connect motors and gearboxes with other moving equipment with capacity to transmit the same or more torque than a gear coupling in the same dimensions. The Quick-Flex coupling's innovative design utilizes an advanced elastomeric element to transmit the torque and therefore eliminates any interference between coupling hubs which can damage equipment.

Timken manufactures precision roller chains that are designed to meet demanding steel industry applications. We build chains to precise specifications for strength and maximum wear life. The offering includes a complete line of roller chains, attachment chains and engineered conveyor chains.

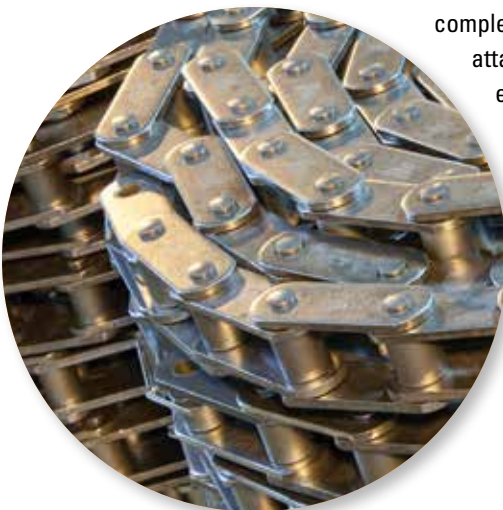

LUBRICATION

Timken® lubricants reduce friction, prevent wear and protect bearing surfaces from corrosion. We offer a wide selection of lubricants, including Timken® Mill Grease, which we formulated to perform in the difficult roll neck bearing environment. Timken® single- and multi-point lubricators and lubrication delivery devices help maintenance professionals simplify their lubrication practices, saving time and money.



CONDITION MONITORING

Powerful diagnostic tools from Timken are designed to detect potential bearing failure before it occurs. A variety of handheld devices and online options – including our ultra-accurate Online Intelligence System – lets you monitor bearing condition, lubrication quality and machine vibration (either periodically or continuously) for increased productivity, safety and peace of mind.



MAINTENANCE TOOLS

Timken® maintenance tools may extend bearing life by facilitating proper installation, removal and service. They also help simplify maintenance practices. We provide induction heaters, impact fitting tools, and hydraulic and mechanical pullers.

SERVICES

Used bearings and related components often can be returned to their original specifications with less time and costs than purchasing new. We offer complete remanufacture and reconditioning services for many components, including bearings, chocks, housings, rolls and more.

Our gearbox repair services are globally recognized for power transmission solutions in heavy industrial markets, repairing virtually any large gearbox make or model, with on-site emergency breakdown service available if needed.

Timken offers a full range of maintenance and reconditioning services through our remanufacturing and repair operations. Using these services can lead to improved plant efficiency and reduced overall production costs.

TRAINING

We offer industry-specific training programs designed for plant professionals, as well as on-site customized training to meet your specific needs. Our training programs are available at select locations around the world and cover every phase of bearing performance. Class time is balanced with extensive hands-on training and tours of Timken facilities.



HOW TO USE THIS CATALOG

We designed this catalog to help you find the Timken bearings best suited to your equipment needs and specifications.

The product tables list many of the bearing types that are specifically used in thrust positions. For other bearing types, please refer to the respective Timken product catalog reference.

Timken offers an extensive range of bearings and accessories in both imperial and metric sizes. For your convenience, size ranges are indicated in millimeters and inches. Contact your Timken engineer to learn more about our complete line for the special needs of your application.

This publication contains dimensions, tolerances and load ratings, as well as engineering sections describing mounting and fitting practices for shafts and housings, internal clearances, materials and other bearing features. It provides valuable assistance in the initial consideration of the type and characteristics of the bearings that may best suit your particular needs.

ISO and ANSI/ABMA, as used in this publication, refer to the International Organization for Standardization and the American National Standards Institute/American Bearing Manufacturers Association.



SHELF LIFE AND STORAGE OF GREASE-LUBRICATED BEARINGS AND COMPONENTS

To help you get the most value from our products, Timken provides guidelines for the shelf life of grease-lubricated ball and roller bearings, components and assemblies. Shelf life information is based on Timken and industry test data and experience.

SHELF LIFE

Shelf life should be distinguished from lubricated bearing/component design life as follows:

Shelf life of the grease-lubricated bearing/component represents the period of time prior to use or installation.

The shelf life is a portion of the anticipated aggregate design life. It is impossible to accurately predict design life due to variations in lubricant bleed rates, oil migration, operating conditions, installation conditions, temperature, humidity and extended storage.

Shelf life values, available from Timken, represent a maximum limit and assume adherence to the storage and handling guidelines suggested in this catalog or by a Timken associate. Deviation from the Timken storage and handling guidelines may reduce shelf life. Any specification or operating practice that defines a shorter shelf life should be used.

Timken cannot anticipate the performance of the grease lubricant after the bearing or component is installed or placed in service.

TIMKEN IS NOT RESPONSIBLE FOR THE SHELF LIFE OF ANY BEARING/COMPONENT LUBRICATED BY ANOTHER PARTY.

European REACH Compliance

Timken lubricants, greases and similar products sold in standalone containers or delivery systems are subject to the European REACH (Registration, Evaluation, Authorization and Restriction of CHemicals) directive. For import into the European Union, Timken can sell and provide only those lubricants and greases that are registered with ECHA (European CHemical Agency). For further information, please contact your Timken engineer.

STORAGE

Timken suggests the following storage guidelines for our finished products (bearings, components and assemblies, referred to as "products"):

- Unless directed otherwise by Timken, products should be kept in their original packaging until they are ready to be placed into service.
- Do not remove or alter any labels or stencil markings on the packaging.
- Products should be stored in such a way that the packaging is not pierced, crushed or otherwise damaged.
- After a product is removed from its packaging, it should be placed into service as soon as possible.



- When removing a product that is not individually packaged from a bulk pack container, the container should be resealed immediately after the product is removed.
- Do not use product that has exceeded its shelf life as defined in the Timken shelf life guidelines statement.
- The storage area temperature should be maintained between 0° C (32° F) and 40° C (104° F); temperature fluctuations should be minimized.
- The relative humidity should be maintained below 60 percent and the surfaces should be dry.
- The storage area should be kept free from airborne contaminants such as, but not limited to, dust, dirt, harmful vapors, etc.
- The storage area should be isolated from undue vibration.
- Extreme conditions of any kind should be avoided.

Due to the fact that Timken is not familiar with your particular storage conditions, we strongly suggest following these guidelines. However, you may be required by circumstances or applicable government requirements to adhere to stricter storage requirements.

Most bearing components typically ship protected with a corrosion-preventive compound that is not a lubricant. These components may be used in oil-lubricated applications without removal of the corrosion-preventive compound. When using some specialized grease lubrications, we advise you to remove the corrosion-preventive compound before packing the bearing components with suitable grease.

 **WARNING**

Failure to observe the following warnings could create a risk of death or serious injury.

Never spin a bearing with compressed air.
The components may be forcefully expelled.
Proper maintenance and handling practices are critical.
Always follow installation instructions and maintain proper lubrication.

NOTE

*Never use steam or hot water when cleaning the bearings because these methods can create rust or corrosion.
Never expose any surface of a bearing to the flame of a torch.
Do not heat bearing beyond 149° C (300° F)*

**WARNING**

Failure to observe the following warnings could create a risk of death or serious injury.

Proper maintenance and handling practices are critical. Always follow installation instructions and maintain proper lubrication.

Overheated bearings can ignite explosive atmospheres. Special care must be taken to properly select, install, maintain, and lubricate housed unit bearings that are used in or near atmospheres that may contain explosive levels of combustible gases or accumulations of dust such as from grain, coal, or other combustible materials.

If hammer and bar are used for installation or removal of a part, use a mild steel bar (e.g., 1010 or 1020 grade). Mild steel bars are less likely to cause release of high-speed fragments from the hammer, bar or the part being removed.

Warnings for this product line are in this catalog and posted on <http://www.timken.com/warnings>.

NOTE

Do not attempt to disassemble unitized bearings. Components may become damaged and affect the performance and service life of the bearing.

Do not mix components of matched assemblies. Mixing components can reduce the service life of the bearing.

NOT TO BE USED AS A DESIGN MANUAL.

This is not a manual for the selection of bearings for new applications. Whenever it is necessary to select

Timken bearings for new applications consult the Timken Engineering Manual (order no. 10424) or get in touch with the nearest office of The Timken Company.

DISCLAIMER

This catalog is provided solely to give you analysis tools and data to assist you in your product selection. Product performance is affected by many factors beyond the control of Timken.

Therefore, the suitability and feasibility of all product selection must be validated by you.

Timken products are sold subject to Timken's terms and conditions of sale, which include its limited warranty and remedy, which terms may be found at <http://www.timken.com/termsandconditionsofsale>. Please consult with your Timken engineer for more information and assistance.

Every reasonable effort has been made to ensure the accuracy of the information in this writing, but no liability is accepted for errors, omissions or for any other reason.

COMPLIANCE

To view the complete engineering catalog, please visit www.timken.com. To order the catalog, please contact your Timken engineer and request a copy of the Timken Engineering Manual (order number 10424).

European REACH compliance Timken-branded lubricants, greases and similar products sold in stand-alone containers or delivery systems are subject to the European REACH (Registration, Evaluation, Authorization and Restriction of CHemicals) directive. For import into the European Union, Timken can sell and provide only those lubricants and greases that are registered with ECHA (European CHemical Agency). For further information, please contact your Timken engineer.

The Timken Company products shown in this catalog may be directly, or indirectly subject to a number of regulatory standards and directives originating from authorities in the USA, European Union, and around the world, including: REACH (EC 1907/2006, RoHS (2011/65/EU), ATEX (94/9/EC), 'CE' MARKING (93/68/EEC), CONFLICT MINERALS (Section 1502 of the Dodd-Frank Wall Street Reform and Consumer Protection Act).

For any questions or concerns regarding the compliance or applicability of Timken products to these, or other unspecified standards, please contact your Timken sales engineer or customer services representative.

Updates are made periodically to this catalog. Visit www.timken.com for the most recent version of the Timken Thrust Bearing Catalog.

ENGINEERING

This engineering section is not intended to be comprehensive, but does serve as a useful guide in thrust bearing selection. To view the complete engineering catalog, please visit www.timken.com. To order the catalog, please contact your Timken engineer and request a copy of the Timken Engineering Manual (order no.10424).

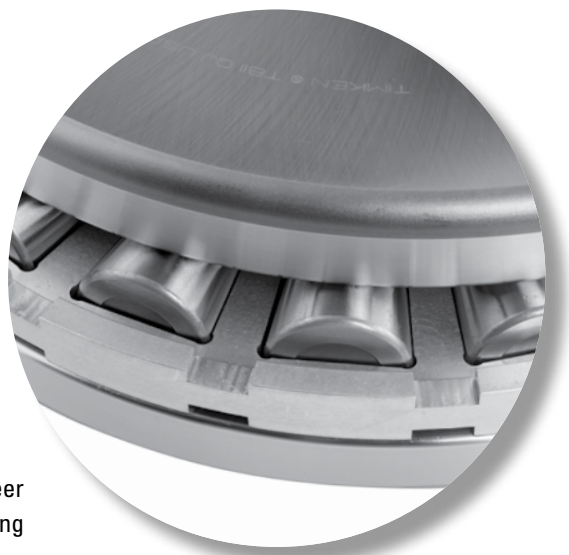

The following topics are covered within this engineering section:

| | |
|--|----|
| Thrust Bearing Types | 14 |
| Bearing Reactions | 20 |
| Bearing Ratings | 22 |
| System Life and Weighted Average Load and Life | 28 |
| Bearing Tolerances, Metric and Inch Systems | 29 |
| Mounting Design, Fitting Practice and Setting | 37 |
| Bearing Operation | 51 |
| Lubrication | 55 |



To view more Timken catalogs, go to www.timken.com/catalogs for interactive versions, or to download a catalog app for your smart phone or mobile device scan the QR code or go to timkencatalogs.squawqr.com.

THRUST BEARING TYPES

Standard types of thrust bearings manufactured by Timken include:

TVL – Single-row angular contact thrust ball bearing.

DTVL – Double-row (two direction) angular contact thrust ball bearing.

TP – Thrust cylindrical roller bearing.

TPS – Self-aligning thrust cylindrical roller bearing.

TSR – Thrust spherical roller bearing.

TTHD – Heavy-duty thrust tapered roller bearing with two tapered raceways. Variants include:

- **TTHDSX** – where one tapered raceway has a convex outer surface for static alignment (SX).
- **TTHDSV** – where one tapered raceway has a concave outer surface for static alignment (SV).

TTHDFL – Heavy-duty thrust tapered roller bearing having one flat and one tapered raceway. Variants include:

- **TTHDFLSA** – where the flat raceway is made of two self-aligning washers (SA).
- **TTHDFLSX** – where the tapered raceway has a convex outer surface for static alignment (SX).
- **TTHDFLSV** – where the tapered raceway has a concave outer surface for static alignment (SV).

TTSP – Steering pivot thrust tapered roller bearing, off-apex design.

TTC – Steering pivot thrust tapered roller bearing, full complement (cageless).

TTD – Double-acting thrust tapered roller bearing.

TXR – Crossed roller bearing.

Each type is designed to take thrust loads. Types TVL, DTVL, TSR and TXR can accommodate radial loads as well. All types reflect advanced design concepts, with large rolling elements for maximum capacity. For some thrust roller bearings, controlled-contour rollers are used to ensure uniform, full-length contact between rollers and raceways resulting in maximum capacity.

Thrust bearings should operate under continuous load for satisfactory performance.

ANGULAR CONTACT THRUST BALL BEARINGS

Thrust ball bearings are used for lighter loads and higher speeds than thrust roller bearings.

TVL

Type TVL is a separable angular contact ball bearing primarily designed for unidirectional thrust loads. The angular contact design, however, will accommodate combined radial and thrust loads since the loads are transmitted angularly through the balls.

The bearing has two hardened and ground steel rings with ball grooves and a one-piece brass cage that spaces the ball complement. The larger ring is called the outer ring, and the smaller the inner ring. Timken standard tolerances for type TVL bearings are equivalent to ABEC 1 where applicable, but higher grades of precision are available.

Usually the inner ring is the rotating member and is shaft mounted. The outer ring is normally stationary and should be mounted with O.D. clearance to allow the bearing to assume its proper operating position. If combined loads exist, the outer ring must be radially located in the housing.

Type TVL bearings should always be operated under thrust load. Normally, this presents no problem as the bearing is usually applied on vertical shafts in oil field rotary tables and machine tool indexing tables. If constant thrust load is not present, it should be imposed by springs or other built-in devices.

Low friction, cool running and quiet operation are advantages of TVL bearings, which may be operated at relatively high speeds. TVL bearings also are less sensitive to misalignment than other types of rigid thrust bearings.

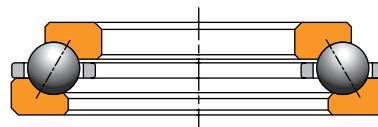

Fig. 1. Type TVL.

DTVL

Type DTVL is similar in design to TVL except that the DTVL has an additional ring and ball complement permitting it to carry moderate thrust in one direction and light thrust in the other direction.



Fig. 2. Type DTVL.

THRUST CYLINDRICAL ROLLER BEARINGS

Thrust cylindrical roller bearings are designed to operate under heavy thrust loads at moderate speeds. Standard versions of these bearings can be operated at peripheral bearing O.D. speeds up to approximately 15 m/s (3000 fpm). Higher operating speeds can be attained with the incorporation of special design features. Consult your Timken engineer for these applications.

For applications where thrust loads are high, lubricants with extreme-pressure (EP) additives should be used. The preferred inlet location for the lubricant is at the bearing bore as centrifugal force will cause the lubricant to distribute radially toward the rollers.

Two types of thrust cylindrical roller bearings, TP and TPS, are available.

TP

Type TP thrust cylindrical roller bearings have two hardened and ground raceways and a window-type steel cage which retains one or more profiled rollers per pocket. When multiple rollers are used in each pocket, they are different lengths and are placed in staggered position relative to rollers in adjacent pockets to create overlapping roller paths. This minimizes wear of the raceways and therefore increases bearing life.

Because of the simplicity of their design, type TP bearings are economical. Shaft and housing seats must be square to the axis of rotation to prevent initial misalignment problems.



Fig. 3. Type TP.

TPS

Type TPS bearings have a lower race comprised of two rings, with the contacting faces spherically ground to provide an aligning feature. As a result, the TPS bearing is self-adjusting to static misalignment. Its use is not, however, suggested for operating conditions where alignment is continuously changing (dynamic misalignment).



Fig. 4. Type TPS.

THRUST SPHERICAL ROLLER BEARINGS

Thrust spherical roller bearings are designed with spherically contoured rollers arranged in a steep angular configuration to achieve a high-thrust capacity with low friction and continuous roller alignment. In addition to thrust loads, they can accommodate moderate radial loads. Maximum allowable bearing O.D. speeds are typically in the 25-30 m/s (5000-6000 fpm) range, depending on size and operating temperature. They represent a combination of radial and thrust bearings, designed to operate even if shaft and housing are, or become, misaligned under load. Thrust spherical roller bearings are preferred when conditions include heavy loads, difficulties in establishing or maintaining housing alignment or when shaft deflection can be expected.

Shaft deflections and housing distortions caused by shock or heavy loads (which lead to misalignment) are compensated for by the internal self-alignment of the bearing elements during operation. Elevated edge stress on rollers, a condition that limits service life on other types of bearings, does not develop in thrust spherical roller bearings.

The thrust spherical roller bearing achieves high-thrust capacity and allows axial misalignment between the inner ring and the outer ring of up to $\pm 2.5^\circ$. Timken thrust spherical roller bearings are now offered exclusively with maximum capacity E-type cage construction (EM-finger type machined bronze cage, EJ-window type steel cage). Those having a bore size less than 320 mm (12.598 in.) are typically offered as TSR-EJ designs, while those with larger bores are typically designated as TSR-EM.

The inherent compensation for misalignment, provided by the spherical roller bearings, offers the designer the opportunity to use weldments for housing frames instead of complex castings. This eliminates high-cost machining operations. When castings are preferred, bore alignment is less critical if spherical roller bearings are specified. Should extreme conditions of loading and/or speed under misalignment be anticipated, contact your Timken engineer before ordering.

TSR-EJ

TSR-EJ bearings use window-type steel cages that wrap around an extension on the inner race to provide a retention means for the cage and rollers. This construction unitizes the cage and roller assembly with the inner ring, and hence simplifies bearing mounting and handling.

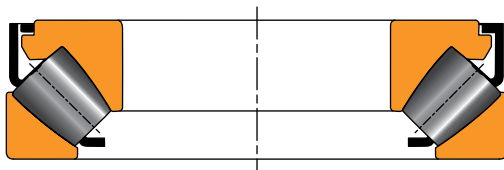

Fig. 5. Type TSR-EJ.

TSR-EM

TSR-EM bearings use finger-type brass cages. The brass cage design provides improved lubrication characteristics over a steel cage and in some cases allows for an additional roller, resulting in higher dynamic load rating. TSR-EM bearings have a roller retention ring, also known as the cage band, mounted and secured to the inner ring to retain the rollers.



Fig. 6. Type TSR-EM.

THRUST TAPERED ROLLER BEARINGS

Thrust tapered roller bearings come in various types and within each type, there are typically several variations. The variation is denoted by a suffix in the bearing type as noted below.

| | |
|-----------|--------------------------------------|
| D | Double acting |
| HD | Heavy duty |
| FL | Flat or freelateral |
| K | Keyway |
| SA | Spherical alignment |
| SV | Spherical concave ring outer profile |
| SX | Spherical convex ring outer profile |
| W | Oil slots |

TTHD, TTHDSX AND TTHDSV

Type TTHD heavy-duty thrust tapered roller bearings have an identical pair of hardened and ground steel rings with tapered raceways, controlled-contour tapered rollers and typically a cage to equally space the rollers. The raceways of both rings and the tapered rollers have a common apex at the bearing center, providing true rolling motion. As a result, maximum speed ratings for TTHD bearings are higher than those of most other thrust bearing types. Type TTHD bearings also can be supplied with a full complement of rollers for low-speed, heavily loaded applications. Full-complement designs offer the highest capacity at somewhat reduced speed capability. Applications for full-complement bearings should be reviewed by your Timken engineer for help in selection of the proper bearing.

TTHD bearings are well-suited for applications where high thrust and/or heavy shock loads are applied and radial positioning is critical. Typical applications for TTHD bearings include crane hooks, oil well swivels, pulp refiners, extruders and piercing mill thrust blocks.

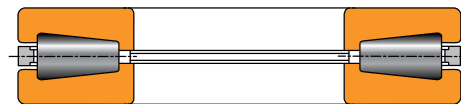

Fig. 7. Type TTHD.

Type TTHDSX and TTHDSV thrust tapered roller bearings have tapered raceways and a full complement of rollers. They are commonly known as screw down bearings in the metals industry. Outer raceways for TTHDSX and TTHDSV bearings have convex and concave outer surfaces, respectively, for the purpose of set-up alignment. They do not have a conventional bore, but are provided with center inserts for attachment purposes as well as lifting.

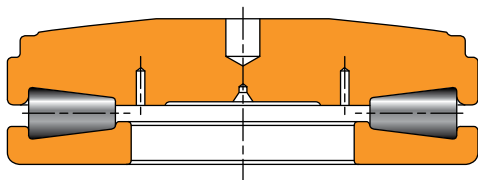

Fig. 8. Type TTHDSX.

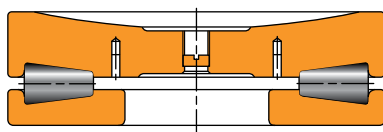

Fig. 9. Type TTHDSV.

TTHDFL, TTHDFLSA, TTHDFLSX AND TTHDFLSV

Types TTHDFL, TTHDFLSA, TTHDFLSX and TTHDFLSV heavy-duty thrust bearings have one tapered raceway, one flat raceway and controlled-contour rollers to optimize stress distribution over the contact surface. These designs combine features offering the highest possible capacity of any thrust bearing of their size and providing superior static thrust capacity. The designs were originally developed for metal scw down rolling mill (breaker block) applications. They also are used in heavily loaded extruders, cone crushers and other applications where a wide range of operating conditions are found.

Type TTHDFL bearings typically use brass cages for smaller sizes and pin-type cages for larger sizes. The pin-type cage includes hardened pins which are inserted through the rollers, allowing closer roller spacing to maximize capacity. Smaller sizes typically use pocket-type machined brass cages. Both the brass and pin-type cages are designed to permit a full flow of lubricant to all critical surfaces, providing cooler operation.



Fig. 10. Type TTHDFL.

Type TTHDFLSA bearings are similar to TTHDFL, except that the bottom race assembly is comprised of two rings, with the contacting faces spherically ground. As a result, the TTHDFLSA bearing is self-adjusting to static misalignment. It should not be used for operating conditions where alignment is continuously changing (dynamic misalignment).

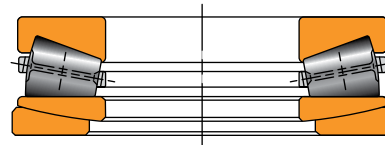

Fig. 11. Type TTHDFLSA.

Types TTHDFLSX and TTHDFLSV are full-complement designs having one raceway with either a convex or concave outer surface for the purpose of static alignment. They are commonly known as screw down bearings in the metals industry. They do not have a conventional bore, but are provided with center inserts for lifting and assembly. The full-complement design offers the highest capacity, but a reduced speed capability compared to other thrust bearings having a flat raceway.

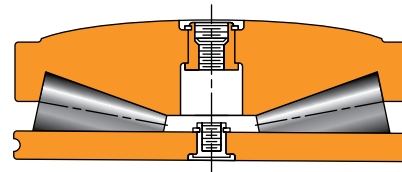

Fig. 12. Type TTHDFLSX.

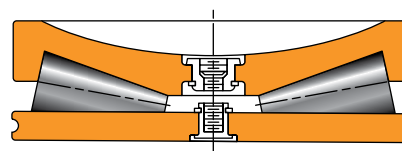

Fig. 13. Type TTHDFLSV.

TTSP, TTSPS AND TTSP L

Types TTSP, TTSPS and TTSP L thrust bearings consist of two tapered races, rollers, cage and outside retainer. The retainer holds the assembly together for shipping and installation. The raceways are off-apex, which means they do not provide true rolling motion. These thrust bearing types are used extensively in oscillating steering pivot applications.

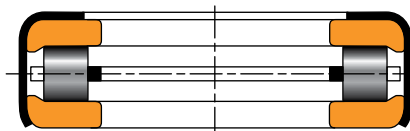

Fig. 14.
Type TTSP.

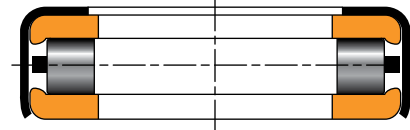

Fig. 15.
Type TTSPS.

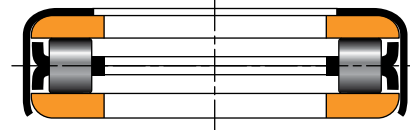

Fig. 16.
Type TTSP L.

TTC, TTCS AND TTCL

Types TTC, TTCS and TTCL are cageless thrust bearings that consist of two tapered thrust raceways, a full complement of tapered rollers and an outside retainer. The outside retainer holds the assembly together for shipping and installation. These types are specifically designed for slow speed and oscillating applications and are identical with the exception of retainer construction.



Fig. 17. Type TTC.

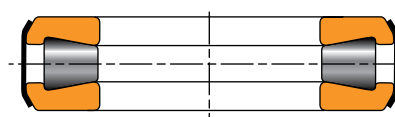

Fig. 18. Type TTCS.

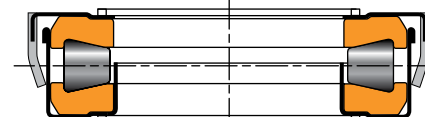

Fig. 19. Type TTCL.

TTD

Type TTD bearings are double-acting thrust tapered roller bearings that can take thrust loads in both axial directions. The inner ring is one piece having two separate raceways, one on each of the outer surfaces. These raceways can be either flat or tapered. For a flat inner raceway, the mating outer ring raceway is tapered and for a tapered inner raceway, the outer ring is flat. The outer rings and cage roller assembly are separable and are not interchangeable. Variations of the TTD bearing include the following features:

TTDW with oil slots.

TTDWK with oil slots and keyway.

TTDK keyway (see variants in figs. 21-22).

TTDFL with flat outer ring raceway.

TTDFLK with flat inner ring raceway and keyway.

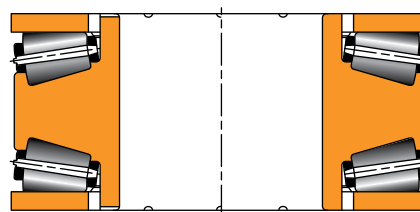

Fig. 20. Type TTDW.

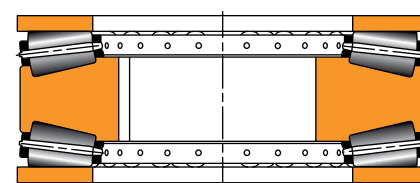

Fig. 21. Type TTDK 1.

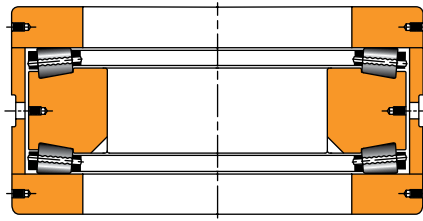

Fig. 22. Type TTDK 2.

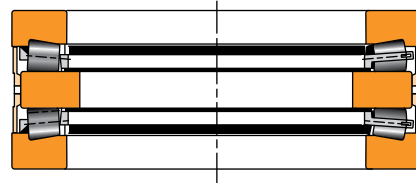

Fig. 23. Type TTDFLK.

TXR – CROSSED ROLLER BEARINGS

A crossed roller bearing is two sets of bearing rings and rollers brought together at right angles with alternate rollers facing opposite directions. TXR bearings have a section height not much greater than that of a TS bearing. The steep angle, tapered geometry of the bearing results in a total effective bearing spread many times greater than the width of the bearing itself. This type of bearing offers a high resistance to overturning moments.

The normal design of the bearing is type TXRD0, which has a double outer ring and two inner rings, with rollers spaced by polymer cages. Another design, Type TXRDI, has a double inner-ring and two outer rings. Crossed roller bearings are manufactured in precision classes. The crossed roller bearing is ideal for machine tool applications such as vertical boring mills, grinding machines, and other similar applications.



Fig. 24. Type TXR crossed roller bearings.

BEARING REACTIONS

DYNAMIC EQUIVALENT THRUST LOAD (P_a)

To calculate the fatigue life of a thrust bearing, it is necessary to calculate a dynamic equivalent thrust load, designated as P_a . The dynamic equivalent thrust load is defined as the single thrust load that, if applied to the bearing, will result in the same life as the combined radial and thrust loading under which the bearing operates. For thrust ball, thrust spherical and thrust tapered roller bearings, the existence of radial loads introduces complex load calculations that must be carefully considered. If the radial load (F_r) is zero, the dynamic equivalent thrust load will be equal to the applied thrust load (F_a).

THRUST BALL, CYLINDRICAL AND TAPERED ROLLER BEARINGS

Thrust cylindrical roller bearings, as well as most thrust ball and thrust tapered roller bearings, are designed to carry thrust load only. The dynamic equivalent thrust load is equal to the applied thrust load (F_a) for these pure thrust applications. For thrust ball and thrust tapered roller bearing applications where radial load is applied, load calculations become much more complex. Please consult your Timken engineer for a review of bearing selection and application.

ANGULAR CONTACT THRUST BALL BEARINGS

For angular contact thrust ball bearings, the dynamic equivalent thrust load is determined by:

$$P_a = X F_r + Y F_a$$

For standard TVL and DTVL bearings having a 50° contact angle, $X = 0.76$ and $Y = 1.00$. Minimum F_a/F_r ratio to maintain proper operation for these applications is 1.56.

THRUST SPHERICAL ROLLER BEARINGS

Thrust spherical roller bearing dynamic loads are determined by:

$$P_a = 1.2F_r + F_a$$

Radial load (F_r) of a thrust spherical roller bearing is proportional to the applied axial load (F_a) such that $F_r \leq 0.55 F_a$. The steep roller angle induces a thrust load ($F_{ai} = 1.2F_r$) when a radial load is applied. This thrust load must be resisted by another thrust bearing on the shaft or by an axial load greater than F_{ai} .

STATIC AXIAL EQUIVALENT LOADS

To compare the load on a non-rotating bearing with the basic static capacity, it is necessary to determine the static equivalent load. In the case of thrust bearings, the static equivalent thrust load is used. The static axial equivalent load is defined as the pure thrust load that produces the same contact pressure in the center of the most heavily stressed rolling element as the actual combined load. The static axial equivalent load is dependent on the bearing type selected. For bearings such as thrust cylindrical roller bearings and most thrust tapered roller bearings that are designed to accommodate thrust loading only, the static axial equivalent load is equal to the applied load. For thrust tapered roller bearings where a radial load or moment is applied, please consult your Timken engineer.

THRUST BALL, CYLINDRICAL AND TAPERED ROLLER BEARINGS

Thrust cylindrical roller bearings, as well as most thrust ball and thrust tapered roller bearings, are designed to carry thrust load only. The static axial equivalent load is equal to the applied thrust load for these pure thrust applications. For thrust ball and thrust tapered roller bearing applications where radial load is applied, load calculations become much more complex. Please consult your Timken engineer for these applications.

ANGULAR CONTACT THRUST BALL BEARINGS

Angular contact thrust ball bearings use the same equation for equivalent static and dynamic loading.

$$P_{oa} = X_o F_r + Y_o F_a$$

For standard TVL and DVL bearings having a 50° contact angle, $X = 0.76$ and $Y = 1.00$.

THRUST SPHERICAL ROLLER BEARINGS

The following equation is used for thrust spherical roller bearings:

$$P_{oa} = F_a + 2.7 F_r$$

MINIMUM BEARING LOAD

THRUST SPHERICAL ROLLER BEARINGS

Centrifugal force in thrust spherical roller bearings tends to propel the rollers outward. The bearing geometry converts this force to induced thrust component, which must be overcome by an axial load. This induced thrust (F_{ac}) is given by:

$$F_{ac} = K_c n^2 \times 10^{-5} \text{ (lbf per RPM)}$$

K_c = centrifugal force constant found in product tables pages 87-91

The minimum required working thrust load on a thrust spherical roller bearing ($F_{a \text{ min}}$) is then computed by:

$$F_{a \text{ min}} = 1.2 F_r + F_{ac} \geq C_{0a}/1000 \text{ (lbf)}$$

In addition to meeting the above calculated value, the minimum required working thrust load ($F_{a \text{ min}}$) should be equal to or greater than 0.1 percent of the static thrust load rating (C_{0a}).

BEARING RATINGS

There are two fundamental load ratings for bearings, a dynamic load rating and a static load rating. The dynamic load rating is used to estimate the life of a rotating bearing. Static load ratings are used to determine the maximum permissible load that can be applied to a non-rotating bearing.

DYNAMIC LOAD RATING

Published dynamic load ratings for Timken bearings are typically based on a rated life of one million revolutions. This rating, designated as C , is defined as the radial load under which a population of bearings will achieve an L_{10} life of one million revolutions. For Timken tapered roller bearings, the dynamic load rating is more commonly based on a rated life of 90 million revolutions, with the designation of C_{90} . This rating is the radial load under which a population of bearings will achieve an L_{10} life of 90 million revolutions. For tapered roller bearings, the dynamic thrust rating also is published and is designated as C_{a90} . The C_{a90} rating is the thrust load under which a population of bearings will achieve an L_{10} life of 90 million revolutions. The dynamic load rating of a bearing is a function of material cleanliness as well as the internal bearing geometry, which includes raceway angles, contact length between rolling elements and raceways, and the number and size of rolling elements.

STATIC LOAD RATING

The basic static radial load rating and thrust load rating for Timken bearings are based on a maximum contact stress within a non-rotating bearing of 4000 MPa (580 ksi) for roller bearings and 4200 MPa (609 ksi) for ball bearings, at the center of contact on the most heavily loaded rolling element.

The 4000 MPa (580 ksi) or 4200 MPa (609 ksi) stress levels may cause visible light Brinell marks on the bearing raceways. This degree of marking will not have a measurable effect on fatigue life when the bearing is subsequently rotating under a lower application load. If sound, vibration or torque is critical, or if a pronounced shock load is present, a lower load limit should be applied. For more information on selecting a bearing for static

load conditions, consult your Timken engineer.

BEARING LIFE

Many different performance criteria exist that dictate how a bearing should be selected. These include bearing fatigue life, rotational precision, power requirements, temperature limits, speed capabilities, sound, etc. This section deals primarily with bearing life as related to material-associated fatigue. Bearing life is defined as the length of time, or number of revolutions, until a fatigue spall of 6 mm² (0.01 in.²) develops. Since fatigue is a statistical phenomenon, the life of an individual bearing is impossible to predetermine precisely. Bearings that may appear to be identical can exhibit considerable life scatter when tested under identical conditions. Thus it is necessary to base life predictions on a statistical evaluation of a large number of bearings operating under similar conditions. The Weibull distribution function is the accepted standard for predicting the life of a population of bearings at any given reliability level.

RATING LIFE

Rating life, (L_{10}), is the life that 90 percent of a group of apparently identical bearings will complete or exceed before a fatigue spall develops. The L_{10} life also is associated with 90 percent reliability for a single bearing under a certain load.

BEARING LIFE EQUATIONS

Traditionally, the L_{10} life has been calculated as follows for bearings under radial or combined loading, where the dynamic equivalent radial load, P_r , has been determined and the dynamic load rating is based on one million cycles:

$$L_{10} = \left(\frac{C}{P_r} \right)^e (1 \times 10^6) \text{ revolutions}$$

$$\text{or } L_{10} = \left(\frac{C}{P_r} \right)^e \left(\frac{1 \times 10^6}{60n} \right) \text{ hours}$$

For thrust bearings, the above equations change to the following:

$$L_{10} = \left(\frac{C_a}{P_a} \right)^e (1 \times 10^6) \text{ revolutions}$$

$$\text{or } L_{10} = \left(\frac{C_a}{P_a} \right)^e \left(\frac{1 \times 10^6}{60n} \right) \text{ hours}$$

$e = 3$ for ball bearings

$= 10/3$ for tapered, cylindrical and spherical roller bearings

Tapered roller bearings typically use a dynamic load rating based on 90 million cycles, denoted as C_{90} , changing the equations as follows:

$$L_{10} = \left(\frac{C_{90}}{P_r} \right)^{10/3} (90 \times 10^6) \text{ revolutions}$$

or $L_{10} = \left(\frac{C_{90}}{P_r} \right)^{10/3} \left(\frac{90 \times 10^6}{60n} \right) \text{ hours}$

and $L_{10} = \left(\frac{C_{a90}}{P_a} \right)^{10/3} (90 \times 10^6) \text{ revolutions}$

or $L_{10} = \left(\frac{C_{a90}}{P_a} \right)^{10/3} \frac{90 \times 10^6}{60n} \text{ hours}$

The traditional form of the equations based on dynamic load ratings of one million cycles is most common and will, therefore, be used throughout the rest of this section. The dynamic equivalent load equations and the life adjustment factors defined in subsequent sections are applicable to all forms of the life equation.

With increased emphasis on the relationship between the reference conditions and the actual environment in which the bearing operates in the machine, the traditional life equations have been expanded to include certain additional variables or factors that affect bearing performance. The approach whereby these factors are considered in the bearing analysis and selection has been termed Bearing Systems Analysis (BSA). For thrust bearings, these factors are currently only applied to thrust tapered and thrust spherical roller bearings. The ABMA expanded bearing life equation is:

$$L_{na} = a_1 a_2 a_3 L_{10}$$

The Timken expanded bearing life equation is:

$$L_{na} = a_1 a_2 a_{3d} a_{3l} a_{3m} a_{3p} \left(\frac{C}{P_r} \right)^e (1 \times 10^6) \text{ revolutions}$$

Where $e = 3$ for ball bearings
 $= 10/3$ for tapered, cylindrical and spherical roller bearings

RELIABILITY LIFE FACTOR (a_1)

Reliability, in the context of bearing life for a group of apparently identical bearings operating under the same conditions, is the percentage of the group that is expected to attain or exceed a specified life. The reliability of an individual bearing is the probability that the bearing will attain or exceed a specified life.

The reliability life adjustment factor is:

$$a_1 = 4.26 \left(\ln \frac{100}{R} \right)^{2/3} + 0.05$$

\ln = natural logarithm (base e)

To adjust the calculated L_{10} life for reliability, multiply by the a_1 factor. If 90 (90 percent reliability) is substituted for R in the above equation, $a_1 = 1$. For $R = 99$ (99 percent reliability), $a_1 = 0.25$. The table below lists the reliability factors for commonly used reliability values.

TABLE 1. RELIABILITY FACTORS

| R (percent) | L_n | a_1 |
|-------------|-----------|-------|
| 90 | L_{10} | 1.00 |
| 95 | L_5 | 0.64 |
| 96 | L_4 | 0.55 |
| 97 | L_3 | 0.47 |
| 98 | L_2 | 0.37 |
| 99 | L_1 | 0.25 |
| 99.5 | $L_{0.5}$ | 0.175 |
| 99.9 | $L_{0.1}$ | 0.093 |

NOTE: The equation for reliability adjustment assumes there is a short minimum life below which the probability of bearing damage is minimal (e.g., zero probability of bearing damage producing a short life). Extensive bearing fatigue life testing has shown the minimum life, below which the probability of bearing damage is negligible, to be larger than predicted using the above adjustment factor. For a more accurate prediction of bearing lives at high levels of reliability, consult your Timken engineer.

MATERIAL LIFE FACTOR (a_2)

The life adjustment factor for bearing material, a_2 , for standard Timken bearings manufactured from bearing quality steel is 1.0. Bearings also are manufactured from premium steels, containing fewer and smaller inclusion impurities than standard steels and providing the benefit of extending bearing fatigue life (e.g., DuraSpexx® bearing). Application of the material life factor requires that fatigue life is limited by nonmetallic inclusions, that contact stresses are approximately less than 2400 MPa (350 ksi), and adequate lubrication is provided. It is important to note that improvements in material cannot offset poor lubrication in an operating bearing system. Consult your Timken engineer for applicability of the material factor.

DEBRIS LIFE FACTOR (a_{3d})

Debris within a lubrication system reduces the life of a roller bearing by creating indentations on the contacting surfaces, leading to stress risers. The Timken life rating equations were developed based on test data obtained with 40 μm oil filtration, and measured ISO cleanliness levels of approximately 15/12, which is typical of cleanliness levels found in normal industrial machinery. When more or less debris is present within the system, the fatigue life predictions can be adjusted according to the measured or expected ISO lubricant cleanliness level to more accurately reflect the expected bearing performance.

A more accurate option for predicting bearing life in a debris environment is to perform a Debris Signature Analysis™. The Debris Signature Analysis is a process for determining the effects of the actual debris present in your system on the bearing performance. The typical way in which this occurs is through measurements of dented/bruised surfaces on actual bearings run in a given application. This type of analysis can be beneficial because different types of debris cause differing levels of performance degradation. Soft, ductile particles can cause differing levels of performance degradation than hard, brittle particles. Hard, ductile particles are typically most detrimental to bearing life. Brittle particles can break down, thus not affecting performance to as large of a degree as hard, ductile particles. For more information on Debris Signature Analysis or the availability of debris-resistant bearings for your application, consult your Timken engineer.

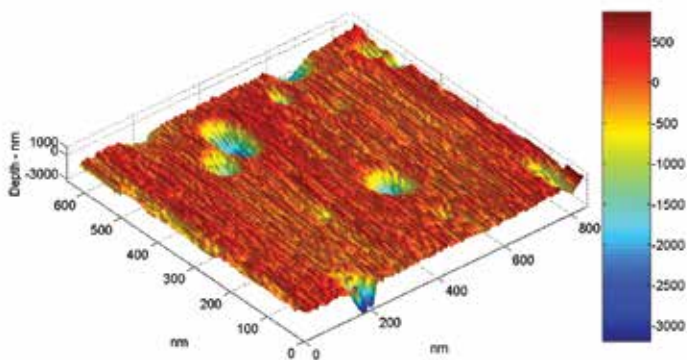

Fig. 25. Surface map of a bearing raceway with debris denting.

LUBRICATION LIFE FACTOR (a_{3l})

The influence of lubrication film on bearing performance is related to the reduction or prevention of asperity (metal-metal) contact between the bearing surfaces. Extensive testing has been done at our technology centers to quantify the effects of the lubrication-related parameters on bearing life. It has been found that the roller and raceway surface finish, relative to lubricant film thickness, has the most notable effect on improving bearing performance. Factors such as bearing geometry, material, loads and load zones also play an important role in bearing performance.

The following equation provides a method to calculate the lubrication factor for a more accurate prediction of the influence of lubrication on bearing life (L_{10a}):

$$a_{3l} = C_g C_l C_s C_v C_{gr}$$

The a_{3l} maximum is 2.88 for all bearings. The a_{3l} minimum is 0.200 for case-carburized bearings and 0.126 for through-hardened bearings. A lubricant contamination factor is not included in the lubrication factor because Timken endurance tests are typically run with a 40 μm filter to provide a realistic level of lubricant cleanness for most applications.

Geometry factor (C_g)

C_g is given for most part numbers that are available in the bearing catalogs on www.timken.com. The geometry factor also includes the material effects and load zone considerations for non-tapered roller bearings, as these also are inherent to the bearing design. However, it should be noted that the primary effect of the load zone is on roller load distributions and contact stresses within the bearing, which are not quantified within the lubrication factor. Refer to the previous section Load Zone Life Factor (a_{3k}) for more information.

The geometry factor (C_g) is not applicable to our DuraSpexx™ product. For more information on our DuraSpexx product, consult your Timken engineer.

Load factor (C_l)

The C_l factor can be obtained from fig. 26. Note that the factor is different based on the type of bearing utilized. P_r is the equivalent load applied to the bearing in Newtons and is determined in the Dynamic Equivalent Bearing Loads (P_r) section.

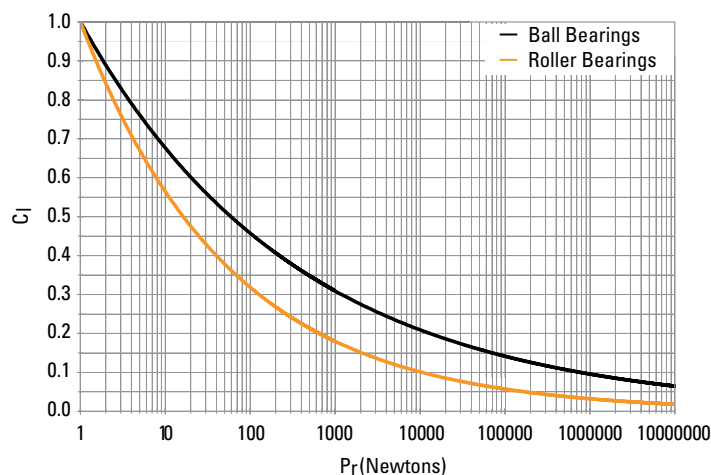

Fig. 26. Load factor (C_l) vs. dynamic equivalent bearing load (P_r).

Speed factor (C_s)

C_s can be determined from fig. 27, where rev/min (RPM) is the rotational speed of the inner ring relative to the outer ring.

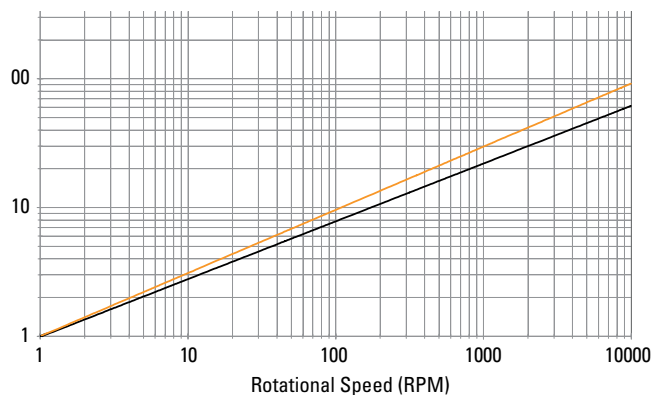

Fig. 27. Speed factor (C_s) vs. rotational speed.

Viscosity factor (C_v)

The lubricant kinematic viscosity (centistokes [cSt]) is taken at the operating temperature of the bearing. The operating viscosity can be estimated by fig. 28. The viscosity factor (C_v) can then be determined from figs. 28 and 29 shown here.

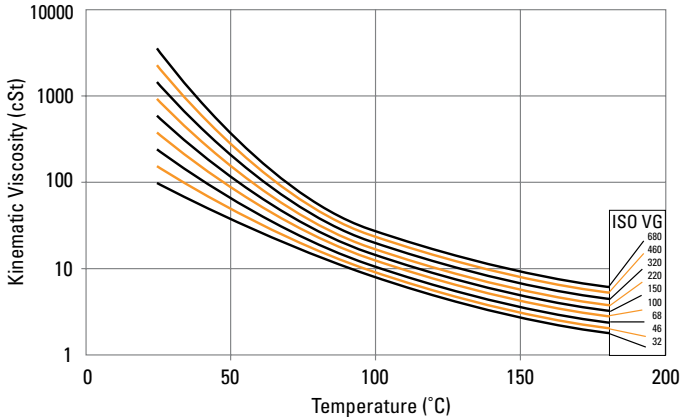

Fig. 28. Temperature vs. kinematic viscosity.

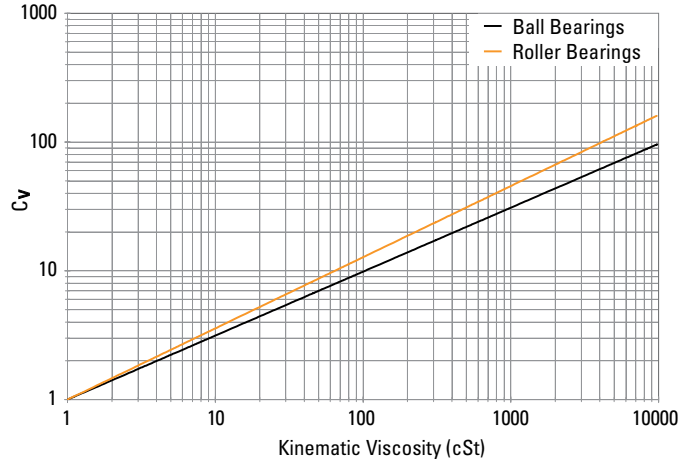

Fig. 29. Viscosity factor (C_v) vs. kinematic viscosity.

LOW-LOAD LIFE FACTOR (a_{3p})

Bearing life tests show greatly extended bearing fatigue life performance is achievable when the bearing contact stresses are low and the lubricant film is sufficient to fully separate the micro-scale textures of the contacting surfaces. Mating the test data with sophisticated computer programs for predicting bearing performance, Timken engineers developed a low-load factor to predict the life increase expected when operating under low-bearing loads. Fig. 30 shows the low-load factor (a_{3p}) as a function of the lubricant life factor (a_{3l}) and the ratio of bearing dynamic rating to the bearing equivalent load.

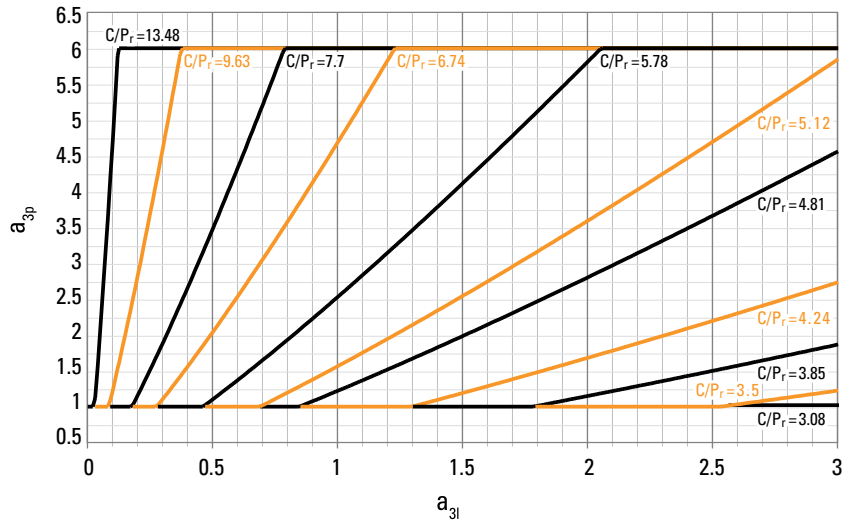

Fig. 30. Low-load life adjustment factor.

GREASE LUBRICATION FACTOR (C_{gr})

Over time, grease degradation causes a reduction in lubricant film thickness. Consequently, a reduction factor (C_{gr}) should be used to adjust for this effect.

$$C_{gr} = 0.79$$

MISALIGNMENT LIFE FACTOR (a_{3m})

Accurate alignment of the shaft relative to the housing is critical for bearing performance. As misalignment increases under moderate to heavy loads, high contact stresses can be generated at the edges of contact between the raceway and rolling element. Special profiling of the raceway or rolling element can, in most cases, offset the effects of misalignment as shown in fig. 31. This figure shows the roller-to-inner ring contact stress of a tapered roller bearing under a misaligned condition with and without special profiling. The profiling significantly reduces the edge stress, resulting in improved bearing performance. The misalignment factor takes into account the effects of profiling on bearing life.

The misalignment factor for thrust spherical roller bearings is 1.0 due to their self-aligning capabilities. The allowable misalignment of a thrust spherical roller bearing is ± 2.5 degrees. Life will be reduced if these limits are exceeded. For misalignment factors for other thrust bearing types, contact your Timken engineer.

Performance of all Timken bearings under various levels of misalignment and radial and axial load can be predicted using sophisticated computer programs. Using these programs, Timken engineers can design special bearing-contact profiles to accommodate the conditions of radial load, axial load and/or bearing misalignment in your application. Consult your Timken engineer for more information.

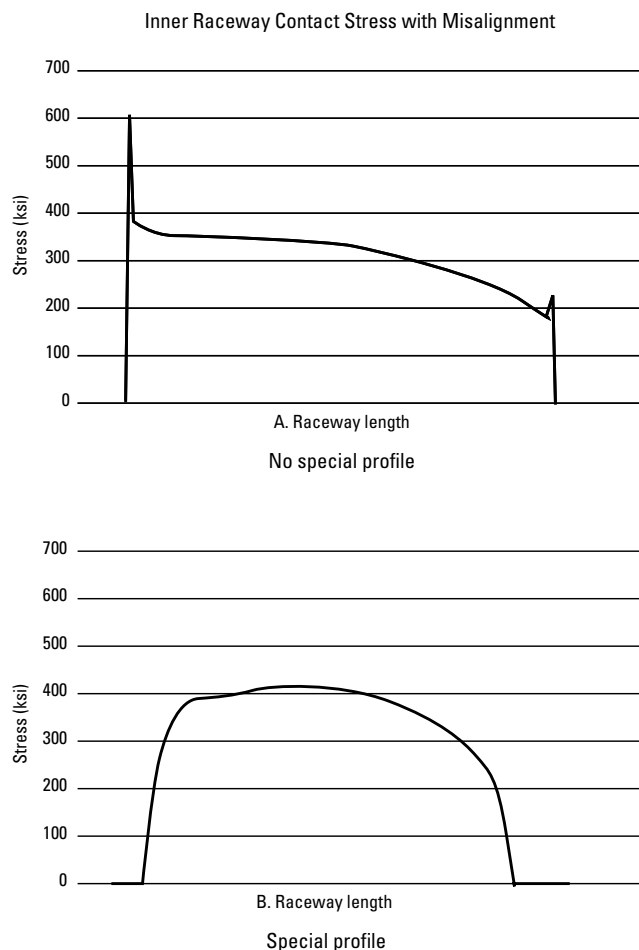

Fig. 31. Tapered roller bearing contact stress under misaligned condition.

SYSTEM LIFE AND WEIGHTED AVERAGE LOAD AND LIFE

SYSTEM LIFE

System reliability is the probability that all of the given bearings in a system will attain or exceed some required life. System reliability is the product of the individual bearing reliabilities in the system:

$$R_{(\text{system})} = R_A R_B R_C \dots R_n$$

In the application, the L_{10} system life for a number of bearings each having different L_{10} life is:

$$L_{10(\text{system})} = [(1/L_{10A})^{3/2} + (1/L_{10B})^{3/2} + \dots (1/L_{10n})^{3/2}]^{-2/3}$$

WEIGHTED AVERAGE LOAD AND LIFE EQUATIONS

In many applications, bearings are subjected to various conditions of loading, and bearing selection is often made on the basis of maximum load and speed. However, under these conditions, a more meaningful analysis may be made by examining the loading cycle to determine the weighted average load.

Bearing selection based on weighted average loading will take into account variations in speed, load and proportion of time during which the variable loads and speeds occur. However, it is still necessary to consider extreme loading conditions to evaluate bearing contact stresses and alignment.

WEIGHTED AVERAGE LOAD

Variable speed, load and proportion time:

$$F_{wt} = [(n_1 t_1 F_1^{10/3} + \dots n_n t_n F_n^{10/3}) / n_a]^{0.3}$$

Uniformly increasing load, constant speed:

$$F_{wt} = [(3/13) (F_{\max}^{13/3} - F_{\min}^{13/3}) / (F_{\max} - F_{\min})]^{0.3}$$

Use of the weighted average load in the bearing life equation does not take into account the effects of different speeds on the lubrication factor a_3 . For load cycles with varying speeds, it is recommended that life calculations be made for each condition and that the life for each condition be plugged into the weighted average life equation.

WEIGHTED AVERAGE LIFE

$$L_{nwt} = 1 / \{ [t_1 / (L_n)_1] + [t_2 / (L_n)_2] + \dots [t_n / (L_n)_n] \}$$

BEARING TOLERANCES, METRIC AND INCH SYSTEMS

Ball and roller bearings are manufactured to a number of specifications, with each having classes that define dimensional tolerances such as inside diameter, outside diameter, width and runout. In addition, bearings are produced in both inch and metric systems with the boundary dimension tolerances being different for these two systems. The major difference between the two systems is that inch bearings have historically been manufactured to positive bore and O.D. tolerances, whereas metric bearings have been manufactured to corresponding standard negative tolerances.

The following table summarizes the different specifications and classes for ball, tapered roller, cylindrical roller and spherical roller bearings. For the purpose of this catalog, ISO specifications are shown for ball, cylindrical roller and spherical roller bearings. Timken specifications are shown for tapered roller bearings. Timken® thrust tapered roller bearings comply with current ABMA inch system standard 23.2. Standard Timken® ball, spherical roller and cylindrical roller thrust bearings maintain normal metric system tolerances according to the current ISO standard 199.

TABLE 2. BEARING SPECIFICATIONS AND CLASSES

| System | Specification | Bearing Type | Standard Bearing Class | | Precision Bearing Class | |
|--------|-------------------------|--|------------------------|--------|-------------------------|--------|
| Metric | Timken | Tapered Roller Bearings | K | N | C | B |
| | ISO/DIN | All Bearing Types | P0 | P6 | P5 | P4 |
| | ABMA | Cylindrical, Spherical Roller Bearings | RBEC 1 | RBEC 3 | RBEC 5 | RBEC 7 |
| | | Ball Bearings | ABEC 1 | ABEC 3 | ABEC 5 | ABEC 7 |
| | | Tapered Roller Bearings (Not XR) | K | N | C | B |
| | Crossed Roller Bearings | – | – | S | P | |
| Inch | Timken | Tapered Roller Bearings | 4 | 2 | 3 | 0 |
| | ABMA | Tapered Roller Bearings | 4 | 2 | 3 | 0 |

The term deviation is defined as the difference between a single ring dimension and the nominal dimension. For metric tolerances, the nominal dimension is at a +0 mm (0 in.) tolerance. The deviation is the tolerance range for the listed parameter. Variation is defined as the difference between the largest and smallest measurements of a given parameter for an individual ring.

Boundary dimension tolerances for Timken thrust bearings are listed in the following tables (pages 30-35). These tolerances are provided for use in selecting bearings for general applications in conjunction with the bearing mounting and fitting practices offered in later sections.

THRUST BALL BEARING TOLERANCES

TABLE 3. THRUST BALL BEARING TOLERANCES – TYPES TVL AND DTVL

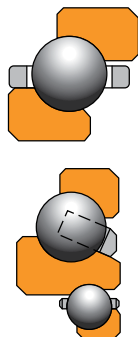

| Bore | | | O.D. | | | Width | | |
|--------------------|---------------------|--------------------------|--------------------|---------------------|--------------------------|---------------|--------|-------------------|
| Bearing Bore | | Tolerance ⁽¹⁾ | Bearing O.D. | | Tolerance ⁽¹⁾ | Bearing Width | | Tolerance Max. |
| Over | Incl. | | Over | Incl. | | Over | Incl. | |
| mm in. | mm in. | mm in. | mm in. | mm in. | mm in. | mm in. | mm in. | mm in. |
| 0.000 0.0000 | 504.825 19.8750 | -0.076 -0.0030 | 0.000 0.0000 | 584.000 23.0000 | -0.076 -0.0030 | All Sizes | | ±0.381 ±0.0150 |
| 504.825 19.8750 | 1524.000 60.0000 | -0.127 -0.0050 | 584.000 23.0000 | 1778.000 70.0000 | -0.127 -0.0050 | | | – |
| | | | | | | | | – |

⁽¹⁾The tolerances in this table conform to ABMA Standard 21.2.

THRUST SPHERICAL ROLLER BEARING TOLERANCES

TABLE 4. THRUST SPHERICAL ROLLER BEARING TOLERANCES

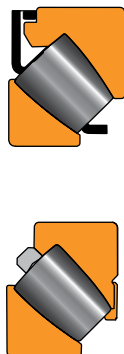

| Bore | | | O.D. | | | Width | | | |
|---------------------|---------------------|--------------------------|---------------------|---------------------|--------------------------|--------------------|--------------------|-------------------|-------------------|
| Bearing Bore | | Tolerance ⁽¹⁾ | Bearing O.D. | | Tolerance ⁽¹⁾ | Bearing Width | | Tolerance | |
| Over | Incl. | | Over | Incl. | | Over | Incl. | Max. | Min. |
| mm in. | mm in. | mm in. | mm in. | mm in. | mm in. | mm in. | mm in. | mm in. | mm in. |
| 80.000 3.1496 | 120.000 4.7244 | -0.020 -0.0008 | 120.000 4.7244 | 150.000 5.9055 | -0.020 -0.0080 | 80.000 3.1496 | 120.000 4.7244 | +0.094 +0.0037 | -0.254 -0.0100 |
| 120.000 4.7244 | 180.000 7.0866 | -0.025 -0.0010 | 150.000 5.9055 | 180.000 7.0866 | -0.025 -0.0010 | 120.000 4.7244 | 180.000 7.0866 | +0.109 +0.0043 | -0.300 -0.0118 |
| 180.000 7.0866 | 250.000 9.8425 | -0.030 -0.0012 | 180.000 7.0866 | 250.000 9.8425 | -0.030 -0.0012 | 180.000 7.0866 | 250.000 9.8425 | +0.130 +0.0051 | -0.366 -0.0144 |
| 250.000 9.8425 | 315.000 12.4016 | -0.036 -0.0014 | 250.000 9.8425 | 315.000 12.4016 | -0.036 -0.0014 | 250.000 9.8425 | 315.000 12.4016 | +0.155 +0.0061 | -0.434 -0.0171 |
| 315.000 12.4016 | 400.000 15.7480 | -0.041 -0.0016 | 315.000 12.4016 | 400.000 15.7480 | -0.041 -0.0016 | 315.000 12.4016 | 400.000 15.7480 | +0.170 +0.0067 | -0.480 -0.0189 |
| 400.000 15.7480 | 500.000 19.6850 | -0.046 -0.0018 | 400.000 15.7480 | 500.000 19.6850 | -0.046 -0.0018 | 400.000 15.7480 | 500.000 19.6850 | +0.185 +0.0073 | -0.526 -0.0207 |
| 500.000 19.6850 | 630.000 24.8031 | -0.051 -0.0020 | 500.000 19.6850 | 630.000 24.8031 | -0.051 -0.0020 | 500.000 19.6850 | and up | +0.203 +0.0080 | -0.584 -0.0230 |
| 630.000 24.8031 | 800.000 31.4961 | -0.076 -0.0030 | 630.000 24.8031 | 800.000 31.4961 | -0.076 -0.0030 | – | – | – | – |
| 800.000 31.4961 | 1000.000 39.3701 | -0.102 -0.0040 | 800.000 31.4961 | 1000.000 39.3701 | -0.102 -0.0040 | – | – | – | – |
| 1000.000 39.3701 | 1250.000 49.2126 | -0.127 -0.0050 | 1000.000 39.3701 | 1250.000 49.2126 | -0.127 -0.0050 | – | – | – | – |
| – | – | – | 1600.000 62.9921 | -0.165 -0.0065 | 0.193 0.0076 | – | – | – | – |
| – | – | – | 2000.000 78.7402 | -0.203 -0.0080 | 0.229 0.009 | – | – | – | – |

⁽¹⁾Tolerance range is from +0 to value listed.

THRUST CYLINDRICAL ROLLER BEARING TOLERANCES

TABLE 5. THRUST CYLINDRICAL ROLLER BEARING TOLERANCES – TYPE TP

| Bore | | | O.D. | | | Width | | |
|--------------|---------|--------------------------|--------------|----------|--------------------------|---------------|---------|----------------|
| Bearing Bore | | Tolerance ⁽¹⁾ | Bearing O.D. | | Tolerance ⁽¹⁾ | Bearing Width | | Tolerance Max. |
| Over | Incl. | | Over | Incl. | | Over | Incl. | |
| mm | mm | mm | mm | mm | mm | mm | mm | mm |
| in. | in. | in. | in. | in. | in. | in. | in. | in. |
| 50.800 | 76.200 | -0.025 | 127.000 | 254.000 | +0.038 | 0.000 | 50.800 | -0.152 |
| 2.0000 | 3.0000 | -0.0010 | 5.0000 | 10.0000 | +0.0015 | 0.0000 | 2.0000 | -0.0060 |
| 76.200 | 88.900 | -0.030 | 254.000 | 457.200 | +0.051 | 50.800 | 76.200 | -0.203 |
| 3.0000 | 3.5000 | -0.0012 | 10.0000 | 18.0000 | +0.0020 | 2.0000 | 3.0000 | -0.0080 |
| 88.900 | 228.600 | -0.038 | 457.200 | 660.400 | +0.640 | 76.200 | 152.400 | -0.254 |
| 3.5000 | 9.0000 | -0.0015 | 18.0000 | 26.0000 | +0.0025 | 3.0000 | 6.0000 | -0.0100 |
| 228.600 | 304.800 | -0.046 | 660.400 | 863.600 | +0.076 | 152.400 | 254.000 | -0.381 |
| 9.0000 | 12.0000 | -0.0018 | 26.0000 | 34.0000 | +0.0030 | 6.0000 | 10.0000 | -0.0150 |
| 304.800 | 457.200 | -0.051 | 863.600 | 1117.600 | +0.102 | 254.000 | 457.200 | -0.508 |
| 12.0000 | 18.0000 | -0.0020 | 34.0000 | 44.0000 | +0.0040 | 10.0000 | 18.0000 | -0.0200 |
| 457.200 | 558.800 | -0.064 | | | | 457.200 | 762.000 | -0.635 |
| 18.0000 | 22.0000 | -0.0025 | | | | 18.0000 | 30.0000 | -0.0250 |
| 558.800 | 762.000 | -0.076 | | | | | | |
| 22.0000 | 30.0000 | -0.0030 | | | | | | |

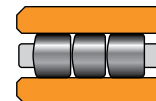

⁽¹⁾The tolerances in this table conform to ABMA Standard 21.2.

TABLE 6. THRUST CYLINDRICAL ROLLER BEARING TOLERANCES – TYPE TPS

| Bore | | | O.D. | | | Width | | |
|--------------|---------|--------------------------|--------------|---------|--------------------------|---------------|---------|----------------|
| Bearing Bore | | Tolerance ⁽¹⁾ | Bearing O.D. | | Tolerance ⁽¹⁾ | Bearing Width | | Tolerance Max. |
| Over | Incl. | | Over | Incl. | | Over | Incl. | |
| mm | mm | mm | mm | mm | mm | mm | mm | mm |
| in. | in. | in. | in. | in. | in. | in. | in. | in. |
| 50.800 | 76.200 | -0.025 | 127.000 | 266.700 | +0.048 | 0.000 | 50.800 | -0.203 |
| 2.0000 | 3.0000 | -0.0010 | 5.0000 | 10.5000 | +0.0019 | 0.0000 | 2.0000 | -0.0080 |
| 76.200 | 88.900 | -0.030 | 266.700 | 323.850 | +0.053 | 50.800 | 76.200 | -0.254 |
| 3.0000 | 3.5000 | -0.0012 | 10.5000 | 12.7500 | +0.0021 | 2.0000 | 3.0000 | -0.0100 |
| 88.900 | 228.600 | -0.038 | 323.850 | 431.800 | +0.058 | 76.200 | 152.400 | -0.381 |
| 3.5000 | 9.0000 | -0.0015 | 12.7500 | 17.0000 | +0.0023 | 3.0000 | 6.0000 | -0.0150 |
| 228.600 | 304.800 | -0.046 | 431.800 | 685.800 | +0.064 | 152.400 | 254.000 | -0.508 |
| 9.0000 | 12.0000 | -0.0018 | 17.0000 | 27.0000 | +0.0025 | 6.0000 | 10.0000 | -0.0200 |
| 304.800 | 457.200 | -0.051 | 685.800 | 889.000 | +0.076 | 254.000 | 457.200 | -0.635 |
| 12.0000 | 18.0000 | -0.0020 | 27.0000 | 35.0000 | +0.0030 | 10.0000 | 18.0000 | -0.0250 |
| 457.200 | 558.800 | -0.064 | | | | 457.200 | 762.000 | -0.762 |
| 18.0000 | 22.0000 | -0.0025 | | | | 18.0000 | 30.0000 | -0.0300 |
| 558.800 | 762.000 | -0.076 | | | | | | |
| 22.0000 | 30.0000 | -0.0030 | | | | | | |

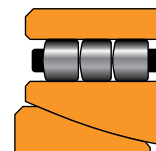

⁽¹⁾The tolerances in this table conform to ABMA Standard 21.2.

THRUST TAPERED ROLLER BEARING TOLERANCES

INCH BEARINGS

Bore tolerances

TABLE 7. THRUST TAPERED ROLLER BEARINGS – BORE TOLERANCES

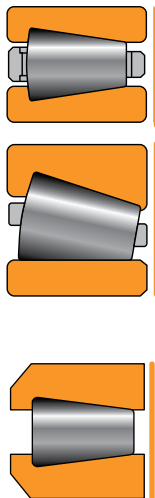

| Bearing Types | Bore | | Tolerance | |
|--|---------------------|---------------------|-------------------|-------------------|
| | Over | Incl. | Max. | Min. |
| | mm in. | mm in. | mm in. | mm in. |
| TTHD TTHDFL TTHDFLSA TTDW TTDK TTHDSX-1 TTHDSX-2 TTHDSV-1 TTHDSV-2 | 0.000 0.0000 | 304.800 12.0000 | +0.025 +0.0010 | +0.000 +0.0000 |
| | 304.800 12.0000 | 609.600 24.0000 | +0.051 +0.0020 | +0.000 +0.0000 |
| | 609.600 24.0000 | 914.400 36.0000 | +0.076 +0.0030 | +0.000 +0.0000 |
| | 914.400 36.0000 | 1219.200 48.0000 | +0.102 +0.0040 | +0.000 +0.0000 |
| | 1219.200 48.0000 | – | +0.127 +0.0050 | +0.000 +0.0000 |
| TTSP TTSPS TTC TTCS TTCL | 0.000 0.0000 | 25.400 1.0000 | +0.076 +0.0030 | -0.076 -0.0030 |
| | 25.400 1.0000 | 76.200 3.0000 | +0.102 +0.0040 | -0.102 -0.0040 |
| | 76.200 3.0000 | – | +0.127 +0.0050 | -0.127 -0.0050 |

INCH BEARINGS

Outside diameter tolerances

TABLE 8. THRUST TAPERED ROLLER BEARINGS – OUTSIDE DIAMETER TOLERANCES

| Bearing Types | O.D. | | Tolerance | |
|--|---------------------|---------------------|-------------------|-------------------|
| | Over | Incl. | Max. | Min. |
| | mm in. | mm in. | mm in. | mm in. |
| TTHD TTHDFL TTHDFLSA TTDW TTDK TTHDSX-1 TTHDSV-1 TTHDSV-2 | 0.000 0.0000 | 304.800 12.0000 | +0.025 +0.0010 | +0.000 +0.0000 |
| | 304.800 12.0000 | 609.600 24.0000 | +0.051 +0.0020 | +0.000 +0.0000 |
| | 609.600 24.0000 | 914.400 36.0000 | +0.076 +0.0030 | +0.000 +0.0000 |
| | 914.400 36.0000 | 1219.200 48.0000 | +0.102 +0.0040 | +0.000 +0.0000 |
| | 1219.200 48.0000 | – | +0.127 +0.0050 | +0.000 +0.0000 |
| TTHDFLSX-1 TTHDFLSX-2 TTHDFLSX-3 TTHDFLSV-1 TTHDFLSV-2 TTHDDV | 0.000 0.0000 | 317.500 12.5000 | +0.000 +0.0000 | -0.025 -0.0010 |
| | 317.500 12.5000 | 647.700 25.5000 | +0.000 +0.0000 | -0.051 -0.0020 |
| TTHDFLSX-1 TTHDFLSX-2 TTHDFLSX-3 TTHDFLSV-1 TTHDFLSV-2 TTHDDV | 0.000 0.0000 | 520.700 20.5000 | +0.000 +0.0000 | -0.127 -0.0050 |
| | 520.700 20.5000 | 647.700 25.5000 | +0.000 +0.0000 | -0.254 -0.0100 |
| TTSP TTSPS TTC TTCS TTCL | 0.000 0.0000 | 127.000 5.0000 | +0.254 +0.0100 | 0.000 0.0000 |
| | 127.000 5.0000 | 203.200 8.0000 | +0.381 +0.0150 | 0.000 0.0000 |
| | 203.200 8.0000 | – | +0.508 +0.2000 | 0.000 0.0000 |

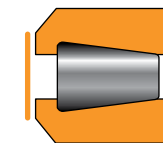
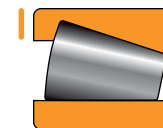
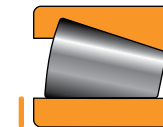
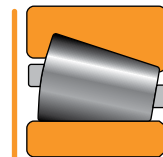
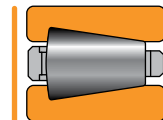

INCH BEARINGS

Width tolerances

TABLE 9. THRUST TAPERED ROLLER BEARING TOLERANCES - WIDTH (INCH)

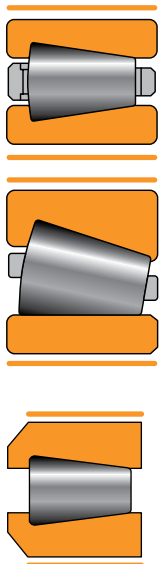

| Bearing Types | Bore | | Tolerance | |
|--|-------------------|-------------------|-------------------|-------------------|
| | Over | Incl. | Max. | Min. |
| | mm in. | mm in. | mm in. | mm in. |
| TTHD TTHDFL TTHDFLSA TTHDSX-1 TTHDSX-2 TTHDSV-1 TTHDSV-2 TTHDFLSX-1 TTHDFLSX-2 TTHDFLSX-3 TTHDFLSV-1 TTHDFLSV-2 TTHDDV | All Sizes | | +0.381 +0.015 | -0.381 -0.015 |
| TTDW TTDK | All Sizes | | +0.762 +0.030 | -0.762 -0.030 |
| TTSP TTSPS TTC TTCS TTCL | 0.000 0.0000 | 76.200 3.0000 | +0.254 +0.0100 | -0.254 -0.0100 |
| | 76.200 3.0000 | 127.000 5.0000 | +0.381 +0.0150 | -0.381 -0.0150 |
| | 127.000 5.0000 | — | +0.508 +0.2000 | -0.508 -0.2000 |

METRIC BEARINGS

TABLE 10. THRUST TAPERED ROLLER BEARINGS – BORE TOLERANCES

| Bearing Types | Bore | | Tolerance | |
|---------------|--------------------|--------------------|-------------------|-------------------|
| | Over | Incl. | Max. | Min. |
| | mm in. | mm in. | mm in. | mm in. |
| TTDFLK | 80.000 3.1496 | 120.000 4.7244 | +0.000 +0.0000 | -0.020 -0.0008 |
| | 120.000 4.7244 | 180.000 7.0866 | +0.000 +0.0000 | -0.025 -0.0010 |
| | 180.000 7.0866 | 250.000 9.8425 | +0.000 +0.0000 | -0.030 -0.0012 |
| | 250.000 9.8425 | 315.000 12.4016 | +0.000 +0.0000 | -0.035 -0.0014 |
| | 315.000 12.4016 | 400.000 15.7480 | +0.000 +0.0000 | -0.040 -0.0016 |
| | 400.000 15.7480 | 500.000 19.6850 | +0.000 +0.0000 | -0.045 -0.0018 |
| | 500.000 19.6850 | 630.000 24.8031 | +0.000 +0.0000 | -0.050 -0.0020 |

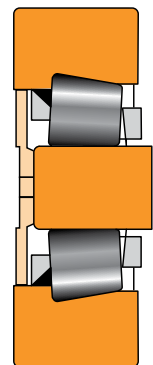
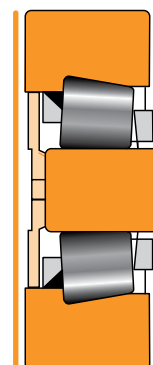

TABLE 11. THRUST TAPERED ROLLER BEARINGS – OUTSIDE DIAMETER TOLERANCES

| Bearing Types | O.D. | | Tolerance | |
|---------------|---------------------|---------------------|-------------------|-------------------|
| | Over | Incl. | Max. | Min. |
| | mm in. | mm in. | mm in. | mm in. |
| TTDFLK | 80.000 3.1496 | 120.000 4.7244 | +0.000 +0.0000 | -0.022 -0.0009 |
| | 120.000 4.7244 | 180.000 7.0866 | +0.000 +0.0000 | -0.025 -0.0010 |
| | 180.000 7.0866 | 250.000 9.8425 | +0.000 +0.0000 | -0.030 -0.0012 |
| | 250.000 9.8425 | 315.000 12.4016 | +0.000 +0.0000 | -0.035 -0.0014 |
| | 315.000 12.4016 | 400.000 15.7480 | +0.000 +0.0000 | -0.040 -0.0016 |
| | 400.000 15.7480 | 500.000 19.6850 | +0.000 +0.0000 | -0.045 -0.0018 |
| | 500.000 19.6850 | 630.000 24.8031 | +0.000 +0.0000 | -0.050 -0.0020 |
| | 630.000 24.8031 | 800.000 31.4961 | +0.000 +0.0000 | -0.075 -0.0030 |
| | 800.000 31.4961 | 1000.000 39.3701 | +0.000 +0.0000 | -0.100 -0.0039 |
| | 1000.000 39.3701 | 1250.000 49.2126 | +0.000 +0.0000 | -0.125 -0.0049 |
| | 1250.000 49.2126 | 1600.000 62.9921 | +0.000 +0.0000 | -0.160 -0.0063 |



Width tolerances

Please contact your Timken engineer for information on the metric thrust bearing width tolerances.

MOUNTING DESIGN, FITTING PRACTICE AND SETTING

To achieve expected bearing performance, it is critical to follow proper mounting design, fitting practices, settings and installation procedures. While there are different practices between thrust tapered roller, cylindrical roller, spherical roller and ball bearings, there are many similarities that apply to all. These similarities are summarized in the sections below, followed by a summary of practices specific to each bearing type.

MOUNTING DESIGN

All bearing types are typically mounted onto a shaft and into a housing where the shaft and housing have surfaces supporting the rings. These surfaces establish the axial location and alignment under all operating conditions. It is essential that a shoulder be square with the bearing ring and of sufficient diameter and axial section to provide adequate backing of the bearing raceway. It also must be of sufficient section to resist axial movement and excessive deflection under loading. Wear resistance at the interface with the bearing rings must be considered.

It is highly recommended that roller bearing shaft seats be ground to a surface finish of $1.6 \mu\text{m}$ ($65 \mu\text{in}$) Ra maximum. Ball bearing seats should be $0.8 \mu\text{m}$ ($32 \mu\text{in}$) for shafts under 2 inches and $1.6 \mu\text{m}$ ($65 \mu\text{in}$) for all other sizes.

When shaft seats are turned, a tighter heavy-duty fit should be selected to ensure interference fit pressure and to prevent rotation. The shaft diameter should be turned to a finish of $3.2 \mu\text{m}$ ($125 \mu\text{in}$) Ra maximum.

Housing inside diameters should be finished to $3.2 \mu\text{m}$ ($125 \mu\text{in}$) Ra maximum.

ANGULAR CONTACT THRUST BALL BEARINGS – TYPES TVL AND DTVL

The TVL is a separable single-row angular contact ball bearing designed for unidirectional axial loads. The angular contact design, however, will accommodate combined radial and axial loads since the loads are transmitted angularly through the balls. The DTVL is similar in design to TVL except that the DTVL has an additional ring and ball complement permitting it to carry moderate forces in both directions.

Both TVL and DTVL are used extensively in rotary table applications in the oil and gas drilling industry. Rotary table operation generates upward and downward axial loads while being supported and positioned by two main thrust bearings, often of the angular contact thrust ball type. The upper or main position takes the predominant downward axial loads. The lower position, which also is known as the hold down bearing, handles the upward axial load and the majority of the radial loading due to gear forces or dynamic imbalance of the rotating components, fixtures and drill pipe.

An example of arrangements of the angular contact thrust ball bearings includes using one size TVL in the main position, and another size in the lower position, as illustrated in fig. 32. Another popular mounting arrangement is to use a single DTVL as a triple-ring combination bearing to handle thrust loads in both directions at the same time (see fig. 33).

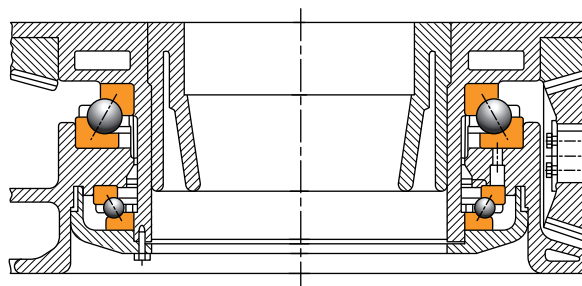

Fig. 32. Large TVL in main position, small TVL in lower position.

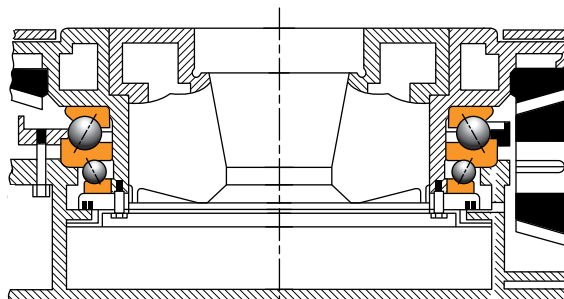

Fig. 33. DTVL mounting to accommodate bi-directional loads.

THRUST CYLINDRICAL ROLLER BEARINGS – TYPES TP AND TPS

Thrust cylindrical roller bearings are generally used in applications where high axial loads are present. Timken TP and TPS thrust cylindrical roller bearings are used in a variety of heavy industrial equipment and challenging thrust applications. Mineral and aggregate crushers and pulverizers are typical examples where thrust cylindrical roller bearings are used in primary thrust support positions to handle the loads applied during the compressive breakdown of aggregate (see fig. 34). Dependent on mounting and axial force applications, these bearings can accommodate moderate overturning moments.

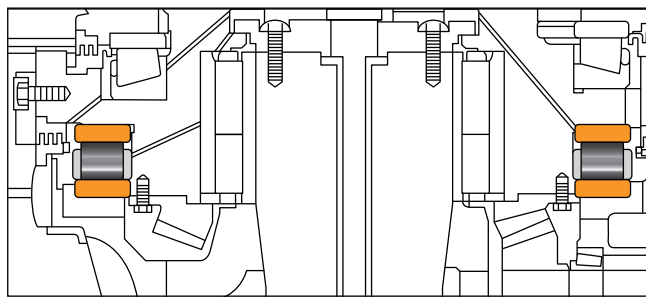

Fig. 34. Typical mounting arrangement of thrust cylindrical roller bearing in crusher application.

Mounting is typically handled by hoisting mechanisms in a shop environment, but may be assembled manually in the field during replacement situations. Mounting of TP and TPS bearings with loose fitting practice on both the shaft and housing is common to allow ease of installation. However, depending on bearing reaction torque, anti-rotation features may be required.

THRUST SPHERICAL ROLLER BEARINGS – TYPE TSR

Thrust spherical roller bearings are used to support axial force in a wide variety of industrial machinery. They can be mounted at axial positions on vertical shafts (e.g. crushers), or mounted horizontally as in long product mill, flat product mill, and cold mill works or intermediate rolls with axial shifting. These assemblies are best suited for applications where accommodation of heavy roll bending and high misalignment is required. Timken thrust spherical roller bearings are capable of handling misalignment between the inner and outer ring of up to 2.5 degrees in either direction.

Bearing outer rings must be mounted with a loose fit to isolate radial loads when used as pure thrust bearings. When used in a shaft position and reacting to radial and axial forces, special housing fitting practice is required. To support axial loads in both directions, thrust spherical roller bearings are often mounted in pairs. In such situations, a spring system maintains the outer races in contact with the rollers on the unloaded row. An axial clearance must be established during mounting using a shim pack between the chock and the cover. Housing components must be designed to accommodate preload springs or precision axial clearance setting.

A cartridge or adapter ring is sometimes used with the inner rings tight fitted on a sleeve and the sleeve loose fitted and keyed on the shaft (see figs. 35 and 36 for typical mountings of EJ and EM styles respectively).

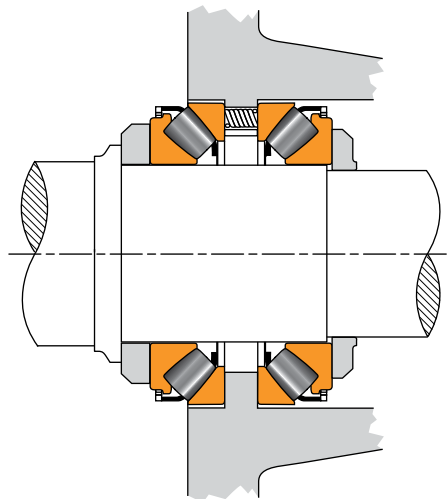

Fig. 35. Back-to-back mounting arrangement of a TSR-EJ bearing set.

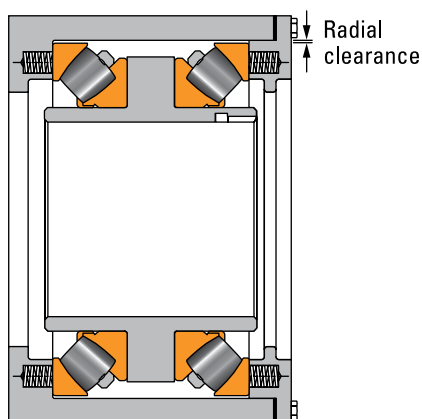

Fig. 36. Face-to-face mounting arrangement of a TSR-EM bearing set.

To maximize axial load support in both directions, thrust spherical roller bearings are often mounted in a tandem face-to-face arrangement (see fig. 36-37). This configuration is common in rollneck applications in the metals industry. In such cases, the inner rings can be clamped in position against each other using inner ring spacers. In applications where surrounding components are mounted in close proximity to the bearing, special care must be taken so that such components do not encroach on the cage or rollers, and so that adequate clearance from the cage and rolling elements is maintained. If there is concern in this regard when mounting thrust spherical roller bearings, contact your Timken representative for support.

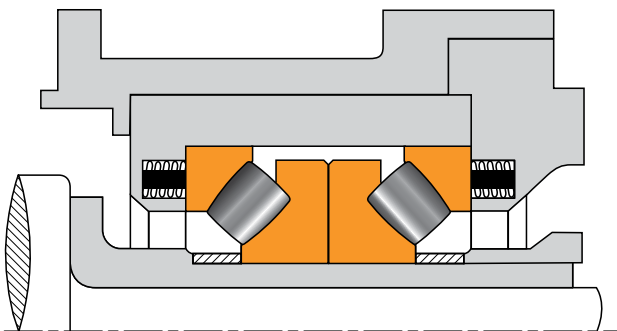

Fig. 37. Typical tandem mount with inner ring spacers.

THRUST TAPERED ROLLER BEARINGS – TYPE TTHD

Thrust tapered roller bearings of type TTHD or TTHDFL are used in a variety of applications such as plastic extruder thrust blocks, oil rig swivels, marine drives and machine tool tables. When mounted, the bearing should be square to the shaft and housing. The backing diameter must be sufficient in the radial direction to support the full length of the rollers, both at the large and small roller ends, and of sufficient axial section to prevent misalignment due to distortion.

In general, the rotating race is mounted with a tight shaft fit, and the stationary race is mounted with a loose housing fit. For TTHDFL, the flat race may be loose fit or tight fit on its outer diameter depending on customer preference.

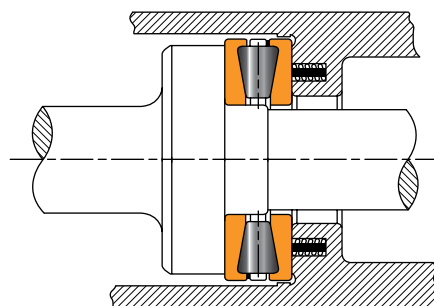

Fig. 38. Typical mounting of a spring-loaded TTHD.

The use of springs is sometimes required on horizontal axis applications where reversing axial loads or shock loads are encountered. Fig. 38 shows a spring-loaded TTHD bearing to keep the housing-supported race in contact with the rolling elements at all times.

THRUST TAPERED ROLLER BEARINGS – SCREWDOWN SYSTEMS – TYPES TTHDSX/SV AND TTHDFLSX/SV

Screwdown bearings of these types are used predominantly in metal mills. The bearings used in screwdown systems include single-row tapered thrust designs that are available in a variety of configurations (see pages 117-126 for further details). The heavy-duty thrust bearing makes the connection between the screwdown and the top roll chock, as shown in fig. 39.

The operating speed of screwdown systems is very low during gap adjustment. Modern mills will either use the electromechanical screwdown system in conjunction with a hydraulic roll force cylinder, or will solely use the hydraulic roll force cylinder. The primary benefit of hydraulic roll force cylinders is their fast response time compared to the electro-mechanical screwdown systems, but the mechanical system gives more precise location with small displacements.

When the mechanical system is used, the screwdown thrust bearing is applied between the main mill screw and top chock. The loads transmitted through these screwdown bearings are extremely high, typically equivalent to half of the mill's separating force, which can be several thousand tons. The operating speed is basically zero as the screw's rotational speed is very slow during adjustment. For this reason, the bearing selection is based on its static capacity (C_0).

Below are a few important considerations to keep in mind when mounting screwdown bearings:

1. **Bearing cartridge:** The bearing is mounted in a cartridge primarily to contain the lubricant needed for the assembly, but also to unitize the entire bearing assembly.
2. **Tapered-bottom race:** If the bottom race is tapered (TTHDSX/SV), then a 3 mm (0.120 in.) radial clearance is suggested relative to the O.D. of the race to ensure that the bottom race will self-align with respect to the upper tapered race. Otherwise, the roller ends will not be properly seated against both the upper and lower large ribs simultaneously. A piloting bushing is pressed into the cartridge and is used for centering the upper race and rollers. The bottom race will be centered by the upper race and roller set.

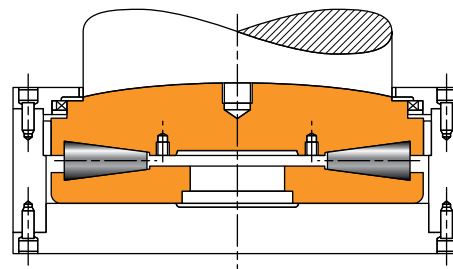

Fig. 39. Typical screwdown support configuration using a TTHDSX thrust bearing.

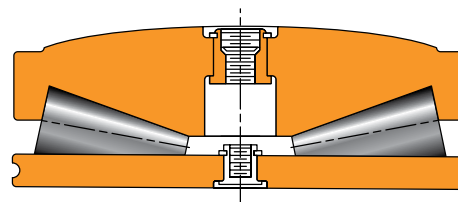

Fig. 40. TTHDFLSX convex upper race design.

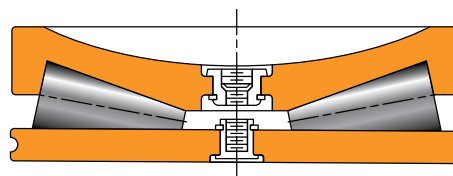

Fig. 41. TTHDFLSV concave upper race design.

3. **Flat-bottom race:** If the bottom race is flat (TTHDFLSX/SV), as in figs. 40-41, then apply close fit as per fitting practice guidelines. The flat race permits radial self-aligning of the rollers and conical raceways.
4. **Sealing:** An oil seal is mounted in the upper plate that is bolted to the cartridge to keep contaminants from entering the bearing assembly.
5. **Lubrication:** Adequate lubrication is maintained by filling the bearing with high-quality EP grease having a viscosity of approximately 450 cSt at 40° C (104° F).

DOUBLE-ACTING HEAVY DUTY THRUST TAPERED ROLLER BEARINGS – TYPES TTDWK AND TTDFLK

The TTDWK or TTDFLK double-acting thrust tapered roller bearing is an excellent choice where extremely high axial loads are anticipated.

Double-acting thrust tapered roller bearings are commonly used in strip mills that generate particularly large thrust forces, as is the case in cross rolling systems.

The TTDWK (fig. 42) bearing includes two flat raceways – one on each side and one tapered double-race thrust ring at the center of the bearing, as well as two sets of rollers that are retained as a unit in a pinned cage.

The TTDFLK (fig. 43), a variant to this TTDWK configuration, uses two tapered raceways (one on each side) and a flat, double-race thrust ring at its center.

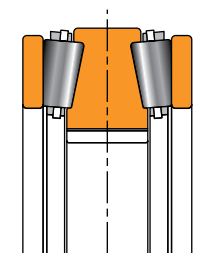

Fig. 42. Typical TTDWK assembly (with flat outer raceways).

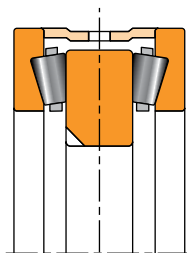

Fig. 43. Typical TTDFLK assembly (with flat double inner raceways).

The TTDWK double-acting thrust bearing is usually mounted in combination with a radial bearing at the fixed position (fig. 44). Such an assembly is fitted in a separate housing that will be mounted on the chock. The outer races are not axially clamped, but adjusted to obtain the required axial clearance, allowing the springs to develop the correct axial force to seat the unloaded row. A keyway is generally provided in the center double-race ring to stop it from rotating on the roll neck.

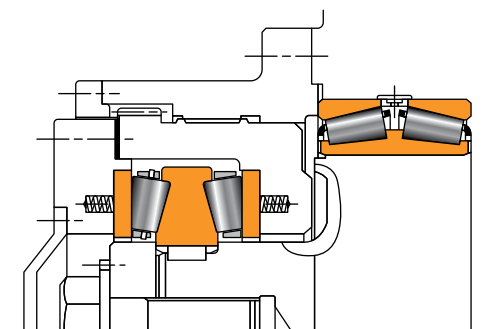

Fig. 44. Typical TTDWK thrust bearing arrangement.

The TTDFLK bearing, on the other hand, is preset and does not require adjustment during mounting. If the bearing is supplied without a spacer, then the same spring arrangement and adjustment as the TTDWK must be used.

The assembly must be axially clamped using metal shims or a compressible gasket, as shown in fig. 45. This bearing can also be ordered without the spacer and then mount it like the TTDWK (fig. 46).

These double-acting bearings (TTDWK and TTDFLK) can only be installed as a unit. Take care to ensure that the flat races are correctly centered when lifting or lowering this bearing into the housing.

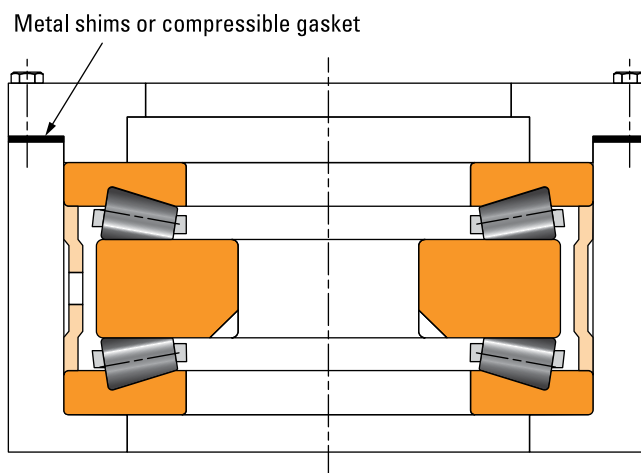

Fig. 45. TTDFLK thrust bearing mounted in housing.

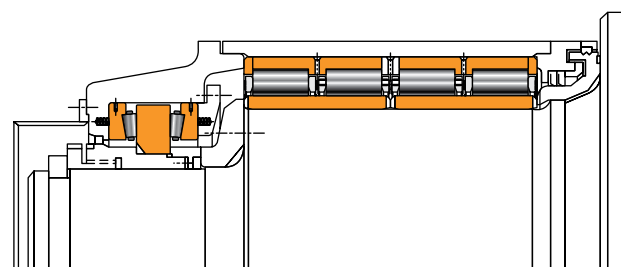

Fig. 46. TTDFLK thrust assembly typical mounting.

CROSSED ROLLER BEARINGS

TXR (DO)

A typical mounting arrangement for the type TXRDO crossed roller bearing is shown in fig. 47.

The arrangement shown is for lubrication by oil circulation in conjunction with an oil level maintained within the bearing. It can, however, be designed for grease lubrication with appropriate sealing arrangements.

The bore of the housing (DH) and the diameter of the spigot (DS) (fig. 48) should be machined to give a mean of the suggested interference fits (pages 48-49).

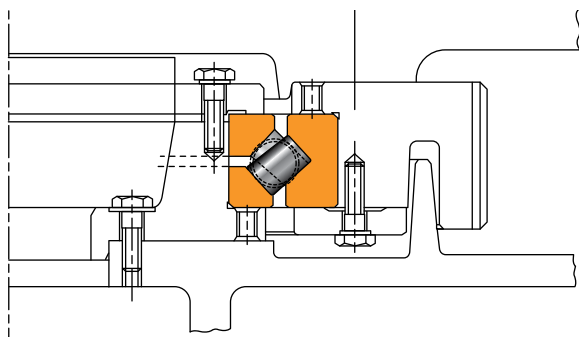

Fig. 47. Typical mounting arrangement of a TXRDO bearing.

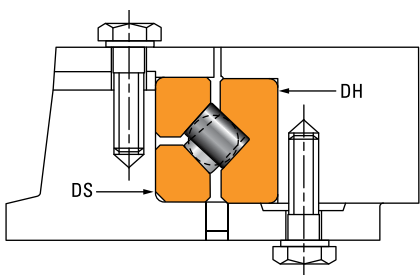

Fig. 48. Fitting and setting of TXR bearing.

The bearing is adjusted externally by segments beneath the top inner-ring clamping plate to get the required preload.

Your Timken engineer should be consulted for more details about the use of crossed roller bearings.

AUXILIARY EQUIPMENT AND OTHER BEARING TYPE MOUNTING PROCEDURES

For industry-standard bearing types, please refer to the following Timken catalogs for mounting procedures – Timken® Tapered Roller Bearing Catalog (order no. 10481), Timken® Cylindrical Roller Bearing Catalog (order no. 10447), Timken® Spherical Roller Bearing Catalog (order no. 10446) and the Timken® Engineering Manual (order no. 10424).

FITTING PRACTICE

As a general guideline, bearing rings mounted on a rotating member should have an interference fit. For some thrust bearing applications, the ring is pinned to the rotating shaft. Loose fits may permit the ring to creep or turn and wear the mating surface and backing shoulder. This wear can result in excessive bearing looseness which can lead to damage of the bearing, shaft or housing. Many thrust bearing applications have outer rings mounted with a clearance to insulate them from radial loads and to allow axial float.

The choice of fitting practices will mainly depend upon the following parameters:

- Precision class of the bearing.
- Rotating or stationary ring.
- Type of layout (single- or double-row bearings).
- Type and direction of load (continuous/alternate rotating, overturning moments).
- Particular running conditions like shocks, vibrations, overloading or high speed.
- Capability for machining the seats (grinding, turning or boring).
- Shaft and housing section and material.
- Mounting and setting conditions.

General fitting practice guidelines for thrust bearings having a bore less than 304.8 mm (12 in.) are:

Rotating race

- Use a tight fit with horizontal shafts; vertical shafts may consider split or loose fit.
- Use a clearance with housing.

Stationary race

- Use a loose fit on shaft and clearance with housing.

For bore sizes greater than 304.8 mm (12 in.), contact your Timken engineer. Detailed fitting practices for various thrust bearing types are listed in the following tables 12-26.

ANGULAR CONTACT THRUST BALL BEARING FITS

Shaft and housing diameters are shown as variance from nominal dimensions.



TABLE 12. SHAFT FITS – ANGULAR CONTACT THRUST BALL BEARINGS – TYPE TVL AND DTVL

| Bearing Bore Nominal | | Shaft Diameter | | | |
|-------------------------|---------------------|---------------------------------|-------------------|--------------------------|-------------------|
| | | Interference Fit ⁽¹⁾ | | Loose Fit ⁽²⁾ | |
| Over | Incl. | Max. | Min. | Max. | Min. |
| mm in. | mm in. | mm in. | mm in. | mm in. | mm in. |
| 0.000 0.0000 | 504.825 19.8750 | +0.076 +0.0030 | +0.000 +0.0000 | -0.152 -0.0060 | -0.076 -0.0030 |
| 504.825 19.8750 | 1524.000 60.0000 | +0.127 +0.0050 | +0.000 +0.0000 | -0.254 -0.0100 | -0.127 -0.0050 |

⁽¹⁾Dowel pin suggested.

⁽²⁾Dowel pin required.

TABLE 13. HOUSING FITS – ANGULAR CONTACT THRUST BALL BEARINGS – TYPE TVL AND DTVL

| Bearing O.D. Nominal | | Housing Diameter | | | |
|-------------------------|---------------------|---------------------------------|-------------------|--------------------------|-----------------|
| | | Interference Fit ⁽¹⁾ | | Loose Fit ⁽²⁾ | |
| Over | Incl. | Max. | Min. | Max. | Min. |
| mm in. | mm in. | mm in. | mm in. | mm in. | mm in. |
| 0.000 0.0000 | 584.000 23.0000 | -0.152 -0.0060 | -0.076 -0.0030 | +0.152 +0.0060 | 0.076 0.0030 |
| 584.000 23.0000 | 1778.000 70.0000 | -0.254 -0.0100 | -0.127 -0.0050 | +0.254 +0.0100 | 0.127 0.0050 |

⁽¹⁾Dowel pin suggested.

⁽²⁾Dowel pin required.

THRUST CYLINDRICAL ROLLER BEARING FITS

Tolerances for housing bore and for shaft diameters shown as variance from nominal bearing dimension.

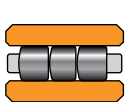

TP

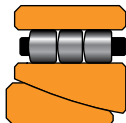

TPS

TABLE 14. SHAFT FITS – THRUST CYLINDRICAL ROLLER BEARING – TYPE TP AND TPS

| Bearing Bore Nominal | | Shaft Diameter | |
|----------------------|--------------------|-------------------|--------------------|
| Over | Incl. | Max. | Min. |
| mm in. | mm in. | mm in. | mm in. |
| 47.625 1.8750 | 53.975 2.1250 | -0.025 -0.0010 | -0.051 -0.0020 |
| 53.975 2.1250 | 63.500 2.5000 | -0.028 -0.0011 | -0.053 -0.0021 |
| 63.500 2.5000 | 76.200 3.0000 | -0.030 -0.0012 | -0.056 -0.0022 |
| 76.200 3.0000 | 88.900 3.5000 | -0.033 -0.0012 | -0.058 -0.0023 |
| 88.900 3.5000 | 177.800 7.0000 | -0.038 -0.0015 | -0.064 -0.0025 |
| 177.800 7.0000 | 228.600 9.0000 | -0.038 -0.0015 | -0.076 -0.0030 |
| 228.600 9.0000 | 304.800 12.0000 | -0.046 -0.0018 | -0.084 -0.00330 |
| 304.800 12.0000 | 381.000 15.0000 | -0.051 -0.0020 | -0.089 -0.0035 |
| 381.000 15.0000 | 482.600 19.0000 | -0.051 -0.0020 | -0.102 -0.0040 |
| 482.600 19.0000 | 584.200 23.0000 | -0.064 -0.0025 | -0.114 -0.0045 |
| 584.200 23.0000 | 762.000 30.0000 | -0.076 -0.0030 | -0.140 -0.0055 |

TABLE 15. HOUSING FITS – THRUST CYLINDRICAL ROLLER BEARING – TYPE TP

| Bearing O.D. Nominal | | Housing Diameter Deviation from D | |
|----------------------|---------------------|-----------------------------------|-------------------|
| Over | Incl. | Max. | Min. |
| mm in. | mm in. | mm in. | mm in. |
| 115.092 4.5312 | 254.000 10.0000 | +0.076 +0.0030 | +0.038 +0.0015 |
| 254.000 10.0000 | 457.200 18.0000 | +0.102 +0.0040 | +0.051 +0.002 |
| 457.200 18.0000 | 558.800 22.0000 | +0.127 +0.0050 | +0.064 +0.0025 |
| 558.800 22.0000 | 660.400 26.0000 | +0.140 +0.0055 | +0.064 +0.0025 |
| 660.400 26.0000 | 711.200 28.0000 | +0.152 +0.0060 | +0.076 +0.0030 |
| 711.200 28.0000 | 863.600 34.0000 | +0.178 +0.0070 | +0.076 +0.0030 |
| 863.600 34.0000 | 965.200 38.0000 | +0.203 +0.0080 | +0.089 +0.0035 |
| 965.200 38.0000 | 1117.600 44.0000 | +0.229 +0.0090 | +0.102 +0.0040 |

TABLE 16. HOUSING FITS – THRUST CYLINDRICAL ROLLER BEARING – TYPE TPS

| Bearing O.D. Nominal | | Housing Diameter Deviation from D | |
|----------------------|---------------------|-----------------------------------|-------------------|
| Over | Incl. | Max. | Min. |
| mm in. | mm in. | mm in. | mm in. |
| 50.800 2.0000 | 60.325 2.3750 | +0.038 +0.0015 | +0.013 +0.0005 |
| 60.325 2.3750 | 82.550 3.2500 | +0.043 +0.0017 | +0.018 +0.0007 |
| 82.550 3.2500 | 93.663 3.6875 | +0.048 +0.0019 | +0.023 +0.0009 |
| 93.663 3.6875 | 101.600 4.0000 | +0.053 +0.0021 | +0.028 +0.0011 |
| 101.600 4.0000 | 115.092 4.5312 | +0.071 +0.0028 | +0.033 +0.0013 |
| 115.092 4.5312 | 254.000 10.0000 | +0.076 +0.0030 | +0.038 +0.0015 |
| 254.000 10.0000 | 457.200 18.0000 | +0.102 +0.0040 | +0.051 +0.0020 |
| 457.200 18.0000 | 558.800 22.0000 | +0.127 +0.0050 | +0.064 +0.0025 |
| 558.800 22.0000 | 660.400 26.0000 | +0.140 +0.0055 | +0.064 +0.0025 |
| 660.400 26.0000 | 711.200 28.0000 | +0.152 +0.0060 | +0.076 +0.0030 |
| 711.200 28.0000 | 863.600 34.0000 | +0.178 +0.0070 | +0.076 +0.0030 |
| 863.600 34.0000 | 965.200 38.0000 | +0.203 +0.0080 | +0.089 +0.0035 |
| 965.200 38.0000 | 1117.600 44.0000 | +0.229 +0.0090 | +0.102 +0.0040 |

THRUST SPHERICAL ROLLER BEARING FITS

Tolerances for housing bore and for shaft diameters are shown as variance from nominal bearing dimension.

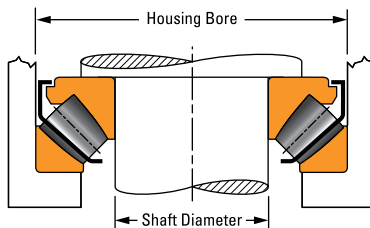

TABLE 17. SHAFT FITS – THRUST SPHERICAL ROLLER BEARINGSS

| Bearing Bore Nominal | | Shaft Diameter | | | |
|-------------------------|--------------------|-------------------|-------------------|-------------------|-------------------|
| | | Stationary Load | | Rotation Load | |
| Over | Incl. | Max. | Min. | Max. | Min. |
| mm in. | mm in. | mm in. | mm in. | mm in. | mm in. |
| 80.000 3.1496 | 120.000 4.7244 | +0.013 +0.0005 | -0.010 -0.0004 | +0.025 +0.0010 | +0.003 +0.0001 |
| 120.000 4.7244 | 180.000 7.0866 | +0.015 +0.0006 | -0.010 -0.0004 | +0.028 +0.0011 | +0.003 +0.0001 |
| 180.000 7.0866 | 200.000 7.8740 | +0.018 +0.0007 | -0.013 -0.0005 | +0.036 +0.0014 | +0.005 +0.0002 |
| 200.000 7.8740 | 240.000 9.4488 | +0.018 +0.0007 | -0.013 -0.0005 | +0.046 +0.0018 | +0.015 +0.0006 |
| 240.000 9.4488 | 315.000 12.4016 | +0.018 +0.0007 | -0.015 -0.0006 | +0.051 +0.0020 | +0.020 +0.0008 |
| 315.000 12.4016 | 400.000 15.7480 | +0.018 +0.0007 | -0.018 -0.0007 | +0.056 +0.0022 | +0.020 +0.0008 |
| 400.000 15.7480 | 500.000 19.6850 | +0.023 +0.0009 | -0.018 -0.0007 | +0.086 +0.0034 | +0.046 +0.0018 |
| 500.000 19.6850 | 630.000 24.8031 | +0.023 +0.0009 | -0.020 -0.0008 | +0.086 +0.0034 | +0.043 +0.0017 |

TABLE 18. HOUSING FITS – THRUST SPHERICAL ROLLER BEARINGS

| Bearing O.D. Nominal | | Housing Bore | | | | | |
|-------------------------|---------------------|--|-------------------|------------------------------|-------------------|------------------------|-------------------|
| | | Springs in Housing Light Radial Load | | Combined Axial & Radial Load | | | |
| Over | Incl. | Max. | Min. | Stationary Outer Ring | | Rotating Outer Ring | |
| mm in. | mm in. | mm in. | mm in. | mm in. | mm in. | mm in. | mm in. |
| 180.000 7.0866 | 250.000 9.8425 | +0.061 +0.0024 | +0.015 +0.0006 | +0.028 +0.0011 | -0.018 -0.0007 | +0.013 +0.0005 | -0.033 -0.0013 |
| 250.000 9.8425 | 315.000 12.4016 | +0.069 +0.0027 | +0.018 +0.0007 | +0.033 +0.0013 | -0.018 -0.0007 | +0.015 +0.0006 | -0.036 -0.0014 |
| 315.000 12.4016 | 400.000 15.7480 | +0.074 +0.0029 | +0.018 +0.0007 | +0.038 +0.0015 | -0.018 -0.0007 | +0.015 +0.0006 | -0.041 -0.0016 |
| 400.000 15.7480 | 500.000 19.6850 | +0.084 +0.0033 | +0.020 +0.0008 | +0.041 +0.0016 | -0.023 -0.0009 | +0.018 +0.0007 | -0.046 -0.0018 |
| 500.000 19.6850 | 630.000 24.8031 | +0.091 +0.0036 | +0.023 +0.0009 | +0.046 +0.0018 | -0.023 -0.0009 | +0.020 +0.0008 | -0.048 -0.0019 |
| 630.000 24.8031 | 800.000 31.4960 | +0.102 +0.0040 | +0.023 +0.0009 | +0.051 +0.0020 | -0.023 -0.0009 | +0.023 +0.0009 | -0.051 -0.0020 |
| 800.000 31.4960 | 1000.000 39.3700 | +0.109 +0.0043 | +0.025 +0.0010 | +0.058 +0.0023 | -0.025 -0.0010 | +0.025 +0.0010 | -0.058 -0.0023 |
| 1000.000 39.3700 | 1250.000 49.2126 | +0.122 +0.0048 | +0.028 +0.0011 | +0.066 +0.0026 | -0.028 -0.0011 | +0.030 +0.0012 | -0.064 -0.0025 |

NOTE

When application calls for thrust loads only, the housing must be relieved by 1.588 mm (0.0625 in.) on diameter so that no radial load is carried on the bearing.

THRUST TAPERED ROLLER BEARING FITS

Tolerances for housing bore and shaft diameters are shown as variance from nominal bearing dimension.

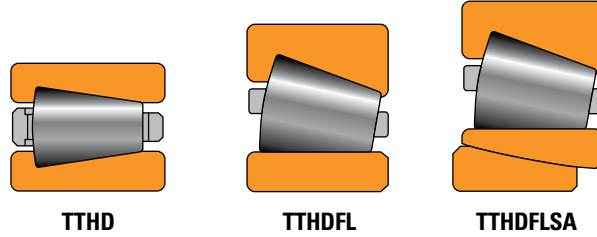

TABLE 19. FITTING GUIDELINES – THRUST TAPERED ROLLER BEARINGS – TYPE TTHD

| Bore | | Rotating Ring | | | | | | Stationary Ring |
|----------|----------|---------------|------------------------------|---------------|-----------|------------------------------|---------------|---|
| Over | Incl. | Tolerance | Class 2 Shaft O.D. Deviation | Resultant Fit | Tolerance | Class 3 Shaft O.D. Deviation | Resultant Fit | Class 2 and 3 |
| mm in. | mm in. | mm in. | mm in. | mm in. | mm in. | mm in. | mm in. | |
| 0.000 | 304.800 | 0.000 | +0.076 | 0.076T | 0.000 | +0.051 | 0.051T | Provide a minimum radial clearance of 2.5 mm (0.1 in.) between ring bore and shaft O.D. - Rotating ring O.D. must have a minimum radial clearance of 2.5 mm (0.1 in.). - TTHD stationary ring O.D. must have a minimum loose fit of 0.25 to 0.37 mm (0.01 to 0.015 in.). - TTHDFL ring when stationary may be loose fit on its O.D. (same as the TTHD) or may be 0.025 to 0.076 mm (0.001 to 0.003 in.) tight. |
| 0.0000 | 12.0000 | +0.025 | +0.050 | 0.025T | +0.013 | +0.038 | 0.025T | |
| | | 0.0000 | +0.0030 | 0.0030T | 0.0000 | +0.0020 | 0.0020T | |
| | | +0.0010 | +0.0020 | 0.0010T | +0.0005 | +0.0015 | 0.0010T | |
| 304.800 | 609.600 | 0.000 | +0.152 | 0.152T | 0.000 | +0.102 | 0.102T | |
| 12.0000 | 24.0000 | +0.051 | +0.102 | 0.051T | +0.025 | +0.076 | 0.051T | |
| | | 0.0000 | +0.0060 | 0.0060T | 0.0000 | +0.0040 | 0.0040T | |
| | | +0.0020 | +0.0040 | 0.0020T | +0.0010 | +0.0030 | 0.0020T | |
| 609.600 | 914.400 | 0.000 | +0.204 | 0.204T | 0.000 | +0.127 | 0.127T | |
| 24.0000 | 36.0000 | +0.076 | +0.127 | 0.051T | +0.038 | +0.089 | 0.051T | |
| | | 0.0000 | +0.0080 | 0.0080T | 0.0000 | +0.0050 | 0.0050T | |
| | | +0.0030 | +0.0050 | 0.0020T | +0.0015 | +0.0035 | 0.0020T | |
| 914.400 | 1219.200 | 0.000 | +0.254 | 0.254T | 0.000 | +0.153 | 0.153T | |
| 36.0000 | 48.0000 | +0.102 | +0.153 | 0.051T | +0.051 | +0.102 | 0.051T | |
| | | 0.0000 | +0.0100 | 0.0100T | 0.0000 | +0.0060 | 0.0060T | |
| | | +0.0040 | +0.0060 | 0.0020T | +0.0020 | +0.0040 | 0.0020T | |
| 1219.200 | | 0.000 | +0.305 | 0.305T | 0.000 | +0.204 | 0.204T | |
| 48.0000 | | +0.127 | +0.178 | 0.051T | +0.076 | +0.127 | 0.051T | |
| | | 0.0000 | +0.0120 | 0.0120T | 0.0000 | +0.0080 | 0.0080T | |
| | | +0.0050 | +0.0070 | 0.0020T | +0.0030 | +0.0050 | 0.0020T | |

TABLE 20. SHAFT FITS – THRUST TAPERED ROLLER BEARINGS TYPE TTHDFL AND TTHDFLSA

| Bearing Bore Nominal | | Shaft Diameter |
|----------------------|----------|---------------------|
| Over | Incl. | Min. ⁽¹⁾ |
| mm in. | mm in. | mm in. |
| 0.000 | 304.800 | -0.051 |
| 0.0000 | 12.0000 | -0.0020 |
| 304.800 | 508.000 | -0.051 |
| 12.0000 | 20.0000 | -0.0020 |
| 508.000 | 711.200 | -0.076 |
| 20.0000 | 28.0000 | -0.0030 |
| 711.200 | 1219.200 | -0.102 |
| 28.0000 | 48.0000 | -0.0040 |
| 1219.200 | 1727.200 | -0.127 |
| 48.0000 | 68.0000 | -0.0050 |

⁽¹⁾Tolerance range is from +0 to value listed.

TABLE 21. HOUSING FITS – THRUST TAPERED ROLLER BEARINGS TYPE TTHDFL AND TTHDFLSA

| Bearing O.D. Nominal | | Housing Bore | |
|----------------------|---------|--------------|---------|
| Over | Incl. | Max. | Min. |
| mm in. | mm in. | mm in. | mm in. |
| 161.925 | 265.113 | +0.060 | +0.025 |
| 6.3750 | 10.4375 | +0.0025 | +0.0010 |
| 265.113 | 317.500 | +0.076 | +0.025 |
| 10.3475 | 12.5000 | +0.0030 | +0.0010 |
| 317.500 | 482.600 | +0.102 | +0.051 |
| 12.5000 | 19.0000 | +0.0040 | +0.0020 |
| 482.600 | 603.250 | +0.113 | +0.051 |
| 19.0000 | 23.7500 | +0.0045 | +0.0020 |
| 603.250 | 711.200 | +0.152 | +0.076 |
| 23.7500 | 28.0000 | +0.0060 | +0.0030 |
| 711.200 | 838.200 | +0.178 | +0.076 |
| 28.0000 | 33.0000 | +0.0070 | +0.0030 |

TABLE 22. SHAFT FITS – THRUST TAPERED ROLLER BEARINGS – TYPE TTD, TTDW, TTDWK, TTDF, TTDFLK

| Bore Range | | Bore Tolerance | Inner Race Seat Deviation | Resultant Fit |
|-----------------|-----------------|----------------|---------------------------|---------------|
| Over | Incl. | | | |
| mm in. | mm in. | mm in. | mm in. | mm in. |
| 0.000 | 76.200 | 0.000 | -51 | 51L |
| 0.0000 | 3.0000 | +0.0000 | -0.0020 | 0.0020L |
| | | +0.0005 | -0.0030 | 0.0035L |
| 76.200 | 101.600 | 0.000 | -76 | 76L |
| 3.0000 | 4.0000 | +0.0000 | -0.0030 | 0.0030L |
| | | +0.0010 | -0.0040 | 0.0050L |
| 101.600 | 127.000 | 0.000 | -102 | 102L |
| 4.0000 | 5.0000 | +0.0000 | -0.0040 | 0.0040L |
| | | +0.0010 | -0.0050 | 0.0060L |
| 127.000 | 152.400 | 0.000 | -127 | 127L |
| 5.0000 | 6.0000 | +0.0000 | -0.0050 | 0.0050L |
| | | +0.0010 | -0.0060 | 0.0070L |
| 152.400 | 203.200 | 0.000 | -152 | 152L |
| 6.0000 | 8.0000 | +0.0000 | -0.0060 | 0.0060L |
| | | +0.0010 | -0.0070 | 0.0080L |
| 203.200 | 304.800 | 0.000 | -178 | 178L |
| 8.0000 | 12.0000 | +0.0000 | -0.0070 | 0.0070L |
| | | +0.0010 | -0.0080 | 0.0090L |
| 304.800 | 609.600 | 0.000 | -203 | 203L |
| 12.0000 | 24.0000 | +0.0000 | -0.0080 | 0.0080L |
| | | +0.0020 | -0.0100 | 0.0120L |
| 609.600 | 914.400 | 0.000 | -254 | 254L |
| 24.0000 | 36.0000 | +0.0000 | -0.0100 | 0.0100L |
| | | +0.0030 | -0.0130 | 0.0160L |
| 914.400 | 1219.200 | 0.000 | -305 | 305L |
| 36.0000 | 48.0000 | +0.0000 | -0.0120 | 0.0120L |
| | | +0.0040 | -0.0160 | 0.0200L |
| 1219.200 | | 0.000 | -305 | 305L |
| 48.0000 | | +0.0000 | -0.0120 | 0.0120L |
| | | +0.0050 | -0.0170 | 0.0220L |

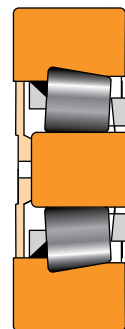

TTDFLK



TTDWK

NOTE

When one ring is piloted by the housing, sufficient clearances must be allowed at the outside diameter of the other ring as well as at the bore of both rings to prevent cross-loading of the rollers. For most applications, this clearance is approximately 1.588 mm (0.0625 in.).

**PRECISION CLASS TXR
TAPERED ROLLER BEARING FITS**

Tolerances for housing bore and shaft diameters are shown as variance from nominal bearing dimension.

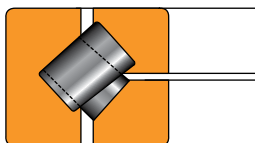

TXR

**TABLE 23. PRECISION CLASS TXR TAPERED ROLLER BEARINGS – SHAFT DIAMETER
TXR CLASSES S AND P (METRIC)**

| Bearing Bore | | Class S | | Class P | |
|----------------|----------------|---------------|---------------|---------------|---------------|
| Range | | Max. | Min. | Max. | Min. |
| Over | Incl. | | | | |
| mm | mm | mm | mm | mm | mm |
| in. | in. | in. | in. | in. | in. |
| – | 50.000 | 0.020T | 0.007T | 0.014T | 0.004T |
| – | 1.9685 | 0.0008T | 0.0003T | 0.0006T | 0.0002T |
| 50.000 | 80.000 | 0.025T | 0.010T | 0.017T | 0.004T |
| 1.9685 | 3.1496 | 0.0010T | 0.0004T | 0.0007T | 0.0002T |
| 80.000 | 120.000 | 0.033T | 0.013T | 0.017T | 0.004T |
| 3.1496 | 4.7244 | 0.0013T | 0.0005T | 0.0007T | 0.0002T |
| 120.000 | 180.000 | 0.052T | 0.027T | 0.017T | 0.004T |
| 4.7244 | 7.0866 | 0.0021T | 0.0011T | 0.0007T | 0.0002T |
| 180.000 | 250.000 | 0.060T | 0.030T | 0.020T | 0.004T |
| 7.0866 | 9.8425 | 0.0024T | 0.0012T | 0.0008T | 0.0002T |
| 250.000 | 315.000 | 0.070T | 0.035T | 0.022T | 0.004T |
| 9.8425 | 12.4016 | 0.0028T | 0.0014T | 0.0009T | 0.0002T |
| 315.000 | 400.000 | 0.077T | 0.037T | 0.024T | 0.004T |
| 12.4016 | 15.7480 | 0.0030T | 0.0015T | 0.0009T | 0.0002T |
| 400.000 | 500.000 | 0.085T | 0.040T | 0.030T | 0.004T |
| 15.7480 | 19.6850 | 0.0034T | 0.0016T | 0.0012T | 0.0002T |

**TABLE 24. PRECISION CLASS TXR TAPERED ROLLER BEARINGS – HOUSING BORE –
TXR CLASSES S AND P (METRIC)**

| Bearing Bore | | Class S | | Class P | |
|----------------|----------------|---------------|---------------|---------------|---------------|
| Range | | Max. | Min. | Max. | Min. |
| Over | Incl. | | | | |
| mm | mm | mm | mm | mm | mm |
| in. | in. | in. | in. | in. | in. |
| – | 50.000 | 0.020T | 0.007T | 0.014T | 0.004T |
| – | 1.9685 | 0.0008T | 0.0003T | 0.0006T | 0.0002T |
| 50.000 | 80.000 | 0.025T | 0.010T | 0.017T | 0.004T |
| 1.9685 | 3.1496 | 0.0010T | 0.0004T | 0.0007T | 0.0002T |
| 80.000 | 120.000 | 0.033T | 0.013T | 0.017T | 0.004T |
| 3.1496 | 4.7244 | 0.0013T | 0.0005T | 0.0007T | 0.0002T |
| 120.000 | 180.000 | 0.052T | 0.027T | 0.017T | 0.004T |
| 4.7244 | 7.0866 | 0.0021T | 0.0011T | 0.0007T | 0.0002T |
| 180.000 | 250.000 | 0.060T | 0.030T | 0.020T | 0.004T |
| 7.0866 | 9.8425 | 0.0024T | 0.0012T | 0.0008T | 0.0002T |
| 250.000 | 315.000 | 0.070T | 0.035T | 0.022T | 0.004T |
| 9.8425 | 12.4016 | 0.0028T | 0.0014T | 0.0009T | 0.0002T |
| 315.000 | 400.000 | 0.077T | 0.037T | 0.024T | 0.004T |
| 12.4016 | 15.7480 | 0.0030T | 0.0015T | 0.0009T | 0.0002T |
| 400.000 | 500.000 | 0.085T | 0.040T | 0.030T | 0.004T |
| 15.7480 | 19.6850 | 0.0034T | 0.0016T | 0.0012T | 0.0002T |

**TABLE 25. PRECISION CLASS TXR TAPERED ROLLER BEARINGS - SHAFT DIAMETER
TXR CLASSES 3 AND 0 (INCH)**

| Bearing Bore | | Class 3 | | Class 0 | |
|----------------------------|----------------------------|--------------------------|--------------------------|--------------------------|--------------------------|
| Range | | Max. | Min. | Max. | Min. |
| Over | Incl. | | | | |
| mm in. | mm in. | mm in. | mm in. | mm in. | mm in. |
| – | 304.800 12.0000 | 0.037T 0.0015T | 0.013T 0.0005T | 0.020T 0.0008T | 0.007T 0.0003T |
| 304.800 12.0000 | 609.600 24.0000 | 0.077T 0.0030T | 0.025T 0.0010T | 0.037T 0.0015T | 0.013T 0.0005T |
| 609.600 24.0000 | 914.400 36.0000 | 0.114T 0.0045T | 0.037T 0.0015T | – | – |
| 914.400 36.0000 | 1219.200 48.0000 | 0.152T 0.0060T | 0.051T 0.0020T | – | – |
| 1219.200 48.0000 | – | 0.191T 0.0075T | 0.064T 0.0025T | – | – |

**TABLE 26. PRECISION CLASS TXR TAPERED ROLLER BEARINGS - HOUSING BORE
TXR CLASSES 3 AND 0 (INCH)**

| Bearing Bore | | Class 3 | | Class 0 | |
|----------------------------|----------------------------|--------------------------|--------------------------|--------------------------|--------------------------|
| Range | | Max. | Min. | Max. | Min. |
| Over | Incl. | | | | |
| mm in. | mm in. | mm in. | mm in. | mm in. | mm in. |
| – | 304.800 12.0000 | 0.037T 0.0015T | 0.013T 0.0005T | 0.020T 0.0008T | 0.007T 0.0003T |
| 304.800 12.0000 | 609.600 24.0000 | 0.077T 0.0030T | 0.025T 0.0010T | 0.037T 0.0015T | 0.013T 0.0005T |
| 609.600 24.0000 | 914.400 36.0000 | 0.114T 0.0045T | 0.037T 0.0015T | – | – |
| 914.400 36.0000 | 1219.200 48.0000 | 0.152T 0.0060T | 0.051T 0.0020T | – | – |
| 1219.200 48.0000 | – | 0.191T 0.0075T | 0.064T 0.0025T | – | – |

SETTING

Thrust bearings are typically set up against another bearing with the setting determined by the application requirements. Most thrust bearings operate under a preload condition.

Correct bearing mounting and fitting practices are key components of proper bearing setting.

INSTALLATION

Proper bearing installation, including cleanliness of the components, as well as use of proper tools, is critical to bearing performance.

Cleanliness of the bearing and mating components is essential for a bearing to achieve maximum service life. Burrs, foreign material and any raised portions of the components mating with the bearing can cause misalignment. Care should be taken to avoid these conditions. Shafts and housings, including lubrication holes, should be thoroughly cleaned before bearing installation. If blind holes are present, insert a magnetic rod to remove metal chips that might have accumulated during manufacture. An air hose may be used on shafts and housings, but should not be used on bearings. Bearings in their shipping containers are typically coated with a rust-inhibitive oil. This oil is compatible with most lubricants and does not need to be removed prior to installation.

Adequate tools must be used to properly fit the inner rings onto the shaft and outer rings into the housing to avoid damage. Direct impact on the rings must be avoided. Inspection of fillets and undercuts should be completed prior to assembly to ensure proper clearance with the bearing.

If applications require a tight interference fit of one or both rings, it is acceptable to heat or cool rings to ease assembly. Standard bearings should not be heated above 120° C (250° F) or cooled below -55° C (-65° F). Precision bearings should not be heated above 65° C (150° F) or cooled below -30° C (-20° F). An alternate method of mounting, generally used on smaller sizes, is to press the bearing onto the shaft or into the housing using an arbor press.

For more information on these installation procedures, please contact your Timken engineer.



WARNING

Failure to observe the following warnings could create a risk of death or serious injury.

Never spin a bearing with compressed air. The components may be forcefully expelled.

Proper maintenance and handling practices are critical. Always follow installation instructions and maintain proper lubrication.



WARNING

Failure to observe the following warnings could create a risk of death or serious injury.

Proper maintenance and handling practices are critical. Always follow installation instructions and maintain proper lubrication.

Overheated bearings can ignite explosive atmospheres. Special care must be taken to properly select, install, maintain, and lubricate housed unit bearings that are used in or near atmospheres that may contain explosive levels of combustible gases or accumulations of dust such as from grain, coal, or other combustible materials.

Consult your equipment designer or supplier for installation and maintenance instructions.

NOTE:

The products cataloged are application specific. Any use in applications other than those intended could lead to equipment failure or to reduced equipment life.

Use of improper bearing fits may cause damage to equipment.

Do not use damaged bearings. The use of a damaged bearing can result in equipment damage.

BEARING OPERATION

OPERATING TEMPERATURES

Bearings operate in a wide range of applications and environments. In most cases, bearing operating temperature is not an issue. Some applications, however, operate at extreme speeds or in extreme temperature environments. In these cases, care must be taken not to exceed the temperature limits of the bearing. Minimum temperature limits are primarily based on lubricant capability. Maximum temperature limits are most often based on material and/or lubricant constraints, but also may be based on accuracy requirements of the equipment that the bearings are built into. These constraints/limitations are discussed below.

BEARING MATERIAL LIMITATIONS

Standard bearing steels with a standard heat treatment cannot maintain a minimum hardness of 58 HRC much above 120° C (250° F).

Dimensional stability of Timken bearings is managed through the proper selection of an appropriate heat-treat process. Standard Timken ball bearings are dimensionally stabilized from -54° C (-65° F) up to 120° C (250° F). Upon request, these bearings can be ordered to higher levels of stability as listed below. These designations are in agreement with DIN Standard 623.

TABLE 27.

| Stability Designation | Maximum Operating Temperature | |
|-----------------------|-------------------------------|-----|
| | °C | °F |
| S0 | 150 | 302 |
| S1 | 200 | 392 |
| S2 | 250 | 482 |
| S3 | 300 | 572 |
| S4 | 350 | 662 |

With dimensionally stabilized product, there still may be some changes in dimensions during service as a result of microstructural transformations. These transformations include the continued tempering of martensite and decomposition of retained austenite. The magnitude of change depends on the operating temperature, the time at temperature and the composition and heat-treatment of the steel.

Temperatures exceeding the limits shown in table 27 require special high-temperature steel. Consult your Timken engineer for availability of specific part numbers for non-standard heat stability or high-temperature steel grades.

Suggested materials for use in balls, rings and rollers at various operating temperatures are listed in table 28. Also listed are chemical composition suggestions, hardness suggestions and dimensional stability information.

Operating temperature affects lubricant film thickness and setting, both of which directly influence bearing life. Extremely high temperatures can result in a reduced film thickness that can lead to asperity contact between contacting surfaces.

Operating temperature also can affect performance of cages, seals and shields, which in turn can affect bearing performance. Materials for these components and their operating temperature ranges are shown in table 28.

LUBRICATION LIMITATIONS

Starting torque in grease-lubricated applications typically increases significantly at cold temperatures. Starting torque is not primarily a function of the consistency or channel properties of the grease. Most often, it is a function of the rheological properties of the grease.

The high-temperature limit for greases is generally a function of the thermal and oxidation stability of the base oil in the grease and the effectiveness of the oxidation inhibitors.

See the LUBRICATION section on page 55 for more information on lubrication limitations.

EQUIPMENT REQUIREMENTS

The equipment designer must evaluate the effects of temperature on the performance of the equipment being designed. Precision machine tool spindles, for example, can be very sensitive to thermal expansions. For some spindles, it is important that the temperature rise over ambient be held to 20° C to 35° C (36° F to 45° F).

Most industrial equipment can operate at considerably higher temperatures. Thermal ratings on gear drives, for example, are based on 93° C (200° F). Equipment such as gas turbines operates continuously at temperatures above 100° C (212° F). Running at high temperatures for extended periods of time, however, may affect shaft and housing fits if the shaft and housing are not machined and heat-treated properly.

Although bearings can operate satisfactorily up to 120° C (250° F), an upper temperature limit of 80° C to 95° C (176° F to 203° F) is more practical. Higher operating temperatures increase the risk of damage from transient temperature spikes. Prototype testing of the application can help define the operating temperature range and should be conducted if possible. It is the responsibility of the equipment designer to weigh all relevant factors and make the final determination of satisfactory operating temperature.

Table 28 provides standard operating temperatures for common bearing component materials. They should be used for reference purposes only. Other bearing component materials are available on request. Contact your Timken engineer for more information.

TABLE 28. OPERATING TEMPERATURES FOR BEARING COMPONENT MATERIALS

| Material | Approximate Chemical Analysis % | Temp. °F | Hardness HRC | -73° C | -54° C | -17° C | 38° C | 93° C | 121° C | 149° C | 204° C | 260° C | 316° C | 371° C | 427° C |
|---|--|------------------|----------------|--|--------|--------|--------|--------|--------|--------|--------|--------|--------|--------|--------|
| | | | | -100° F | -65° F | 0° F | 100° F | 200° F | 250° F | 300° F | 400° F | 500° F | 600° F | 700° F | 800° F |
| Low-alloy carbon-chromium bearing steels. 52100 and others per ASTM A295 | 1C 0.5-1.5Cr 0.35Mn | 70 | 60 | STANDARD DIMENSIONAL STABILIZATION <0.0001 in./in dimensional change in 2500 hours at 100° C (212° F). Good oxidation resistance. | | | | | | | | | | | |
| Low-alloy carbon-chromium bearing steels. 52100 and others per ASTM A295 | 1C 0.5-1.5Cr 0.35Mn | 70 350 450 | 58 56 54 | Heat stabilized <0.0001 in./in dimensional change in 2500 hours at 149° C (300° F). When given a stabilizing heat treatment, A295 steel is suitable for many applications in the 177°-232° C (350-450° F) range; however, it is not as dimensionally stable as it is at temperatures below 177° C (350° F). If utmost stability is required, use materials in the 316° C (600° F) group below. | | | | | | | | | | | |
| Deep-hardening steels for heavy sections per ASTM A485 | 1C 1-1.8Cr 1-1.5Mn .06Si | 70 450 600 | 58 55 52 | As heat-treated and tempered, it is stabilized, <0.0001 in./in dimensional change in 2500 hours at 149° C (300° F). | | | | | | | | | | | |
| Carburizing steels per ASTM A534 a) low alloy 4118, 8X19, 5019, 8620 (Ni-Moly grades) b) high nickel 3310 | Ni-Moly: 0.2C, 0.4-2.0Mn, 0.3-0.8Cr, 0-2.0Ni, 0-0.3Mo .01C, 1.5Cr, 0.4Mn, 3.5Ni | 70 | 58 | Nickel-Moly grades of steel frequently used to achieve extra ductility in inner rings for locking device bearings. 3311 and others used for extra-thick-section rings. | | | | | | | | | | | |
| Corrosion-resistant 440C stainless steel per ASTM A756 | 1C 18Cr | 70 | 58 | Excellent corrosion resistance. | | | | | | | | | | | |
| Corrosion-resistant 440C stainless steel per ASTM A756 | 1C 18Cr | 70 450 600 | 58 55 52 | As heat stabilized for maximum hardness at high temperatures. Good oxidation resistance at higher temperatures. Note load capacity drops off more rapidly at higher temperatures than M50 shown below, which should be considered if loads are high, <0.0001 in./in dimensional change in 1200 hours. | | | | | | | | | | | |
| M-50 medium high speed | 4Cr 4Mo 1V 0.8C | 70 450 600 | 60 59 57 | Suggested where stable high hardness at elevated temperature is required, <0.0001 in./in dimensional change in 1200 hours at 316° C (600° F). | | | | | | | | | | | |

NOTE: Dimensional stability data shown above is the permanent metallurgical growth and/or shrinkage only. Thermal expansion effects are not included. For operating temperatures above 427° C (800° F), consult your Timken engineer.

HEAT GENERATION AND DISSIPATION

Bearing operating temperature is dependent upon a number of factors, including heat generation of all contributing heat sources, heat flow rate between sources and the ability of the system to dissipate the heat. Heat sources include such things as bearings, seals, gears, clutches and oil supply. Heat dissipation is affected by many factors, including shaft and housing materials and designs, lubricant circulation and external environmental conditions. These and other factors are discussed in the following sections.

HEAT GENERATION

Under normal operating conditions, most of the torque and heat generated by the bearing is caused by the elastohydrodynamic losses at the roller/ring contacts.

Heat generation is the product of bearing torque (M) and speed (n). The following equation is used to calculate the heat generated.

$$Q_{gen} = k_4 n M$$

Where:

$$k_4 = 0.105 \text{ for } Q_{gen} \text{ in W when } M \text{ in N-m}$$

$$= 6.73 \times 10^{-4} \text{ for } Q_{gen} \text{ in Btu/min when } M \text{ in lbf-in.}$$

If the bearing is tapered, the torque can be calculated using the following equation.

$$M = k_1 G_1 (n\mu)^{0.5} (F_a)^{0.3}$$

Where:

$$k_1 = \text{bearing torque constant}$$

$$= 7.97 \times 10^{-6} \text{ for } M \text{ in N-m}$$

$$= 1.1 \times 10^{-4} \text{ for } M \text{ in lbf-in.}$$

$$F_a = \text{thrust load}$$

$$\mu = \text{lubricant viscosity}$$

$$G_1 = \text{bearing geometry factor}$$

(Part-specific; please contact your Timken representative.)

For thrust cylindrical and spherical roller bearings, the torque equations are given as follows, where the coefficients are based on series and found table 29:

$$M = \left\{ \begin{array}{l} f_1 F_a dm + 10^{-7} f_0 (v \times n)^{2/3} dm^3 \text{ if } (v \times n) \geq 2000 \\ f_1 F_a dm + 160 \times 10^{-7} f_0 dm^3 \text{ if } (v \times n) < 2000 \end{array} \right\}$$

Note that the viscosity is in units of centistokes and dm is the mean bearing diameter.

TABLE 29. COEFFICIENTS FOR THE TORQUE EQUATION

| Bearing Type | Dimension Series | f_0 | f_1 |
|------------------------------------|------------------|-------|---------|
| Thrust cylindrical roller bearings | 11 | 3 | 0.00150 |
| | 12 | 4 | 0.00150 |
| Thrust spherical roller bearings | 92 | 2.5 | 0.00023 |
| | 93 | 2.5 | 0.00023 |
| | 94 | 3 | 0.00030 |

HEAT DISSIPATION

The problem of determining the heat flow from a bearing in a specific application is rather complex. In general, it can be said that factors affecting the rate of heat dissipation include the following:

1. Temperature gradient from the bearing to the housing. This is affected by size configuration of the house and any external cooling such as fans, water cooling or fan action of the rotating components.
2. Temperature gradient from the bearing to the shaft. Any other heat sources, such as gears and additional bearings and their proximity to the bearing considered, will influence the temperature of the shaft.
3. The heat carried away by a circulating oil system.

To what extent nos. 1 and 2 can be controlled will depend on the application. The heat-dissipation modes include conduction through the system, convection along the inside and outside surfaces of the system, as well as radiation exchange to and from neighboring structures. In many applications, overall heat dissipation can be divided into two categories – heat removed by circulating oil and heat removed through the structure.

Heat dissipation by circulating oil

The amount of heat removed by the lubricant can be controlled more easily. In a splash lubrication system, cooling coils may be used to control the bulk oil temperature.

The amount of heat carried away in a circulating oil system by the lubricant can be approximated from the following equations.

$$Q_{oil} = 1.67 \times 10^{-5} v C_p \rho (\theta_o - \theta_i)$$

Where:

V = oil flow rate (L/min)

C_p = Specific Heat of Lubricant (J/(kg- °C))

ρ = lubricant density (kg/m³)

θ_i = oil inlet temperature

θ_o = oil outlet temperature

DISCLAIMER

If a more thorough knowledge of bearing torque, power losses and system temperatures is needed, contact your Timken representative.

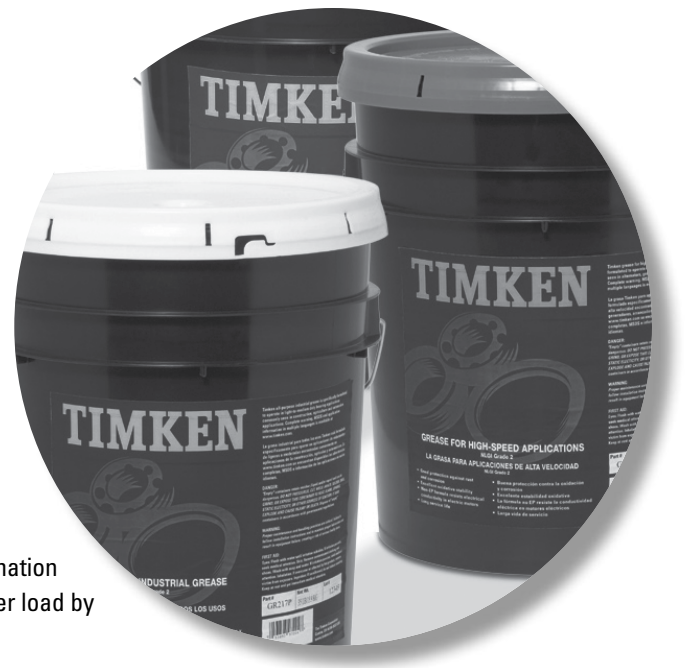

LUBRICATION

To help maintain a bearing's antifriction characteristics, lubrication is needed to:

- Minimize rolling resistance due to deformation of the rolling elements and raceway under load by separating the mating surfaces.
- Minimize sliding friction occurring between rolling elements, raceways and cage.
- Transfer heat (with oil lubrication).
- Protect from corrosion and, with grease lubrication, from contaminant ingress.

LUBRICATION

The wide range of bearing types and operating conditions precludes any simple, all-inclusive statement or guideline for selecting the proper lubricant. At the design level, the first consideration is whether oil or grease is best for the particular operation. The advantages of oil and grease are outlined in table 30. When heat must be carried away from the bearing, oil must be used. Oil is almost always preferred for very high-speed applications.

TABLE 30. ADVANTAGES OF OIL AND GREASE

| Oil | Grease |
|--|---|
| Carries heat away from the bearings | Simplifies seal design and acts as a sealant |
| Carries away moisture and particulate matter | Permits prelubrication of sealed or shielded bearings |
| Easily controlled lubrication | Generally requires less frequent lubrication |

European REACH compliance

Timken-branded lubricants, greases and similar products sold in stand-alone containers or delivery systems are subject to the European REACH (**R**egistration, **E**valuation, **A**uthorization and **R**estriction of **C**hemicals) directive. For import into the European Union, Timken can sell and provide only those lubricants and greases that are registered with ECHA (European Chemical Agency). For further information, please contact your Timken engineer.

OIL LUBRICATION

Oils used for bearing lubrication should be high-quality mineral oils or synthetic oils with similar properties. Selection of the proper type of oil depends on bearing speed, load, operating temperature and lubrication method. In addition to the above, some features and advantages of oil lubrication are:

- Oil is a better lubricant for high speeds or high temperatures. It can be cooled to help reduce bearing temperature.
- It is easier to handle and control the amount of lubricant reaching the bearing. It is harder to retain in the bearing. Lubricant losses may be higher than with grease.
- Oil can be introduced to the bearing in many ways, such as drip-feed, wick-feed, pressurized circulating systems, oil bath or air-oil mist. Each is suited for certain types of applications.
- Oil is easier to keep clean for recirculating systems.

Oil may be introduced to the bearing housing in many ways. The most common systems are:

- **Oil bath.** The housing is designed to provide a sump through which the rolling elements of the bearing will pass. Generally, the oil level should be no higher than the center point of the lowest rolling element. If speed is high, lower oil levels should be used to reduce churning. Gages or controlled elevation drains are used to achieve and maintain the proper oil level.
 - **Circulating system.** This system has the advantages of:
 - An adequate supply of oil for both cooling and lubrication.
 - Metered control of the quantity of oil delivered to each bearing.
 - Removal of contaminants and moisture from the bearing by flushing action.
 - Suitability for multiple bearing installations.
 - Large reservoir, which reduces deterioration.
 - Increased lubricant life provides economical efficiency.
 - Incorporation of oil-filtering devices.
 - Positive control to deliver the lubricant where needed.
 - A typical circulating oil system consists of an oil reservoir, pump, piping and filter. A heat exchange may be required.
 - **Oil-mist lubrication.** Oil-mist lubrication systems are used in high-speed, continuous-operation applications. This system permits close control of the amount of lubricant reaching the bearings. The oil may be metered, atomized by compressed air and mixed with air, or picked up from a reservoir using a venturi effect. In either case, the air is filtered and supplied under sufficient pressure to ensure adequate lubrication of the bearings. Control of this type of lubrication system is accomplished by monitoring the operating temperatures of the bearings being lubricated. The continuous passage of the pressurized air and oil through the labyrinth seals used in the system prevents the entrance of contaminants from the atmosphere to the system.
- The successful operation of this type of system is based upon the following factors:
- Proper location of the lubricant entry ports in relation to the bearings being lubricated.
 - Avoidance of excessive pressure drops across void spaces within the system.

- Proper air pressure and oil quantity ratio to suit the particular application.
- Adequate exhaust of the air-oil mist after lubrication has been accomplished.

To ensure “wetting” of the bearings, and to prevent possible damage to the rolling elements and rings, it is imperative that the oil-mist system be turned on for several minutes before the equipment is started. The importance of “wetting” the bearing before starting cannot be overstated, and it also has particular significance for equipment that has been idled for extended periods of time.

Lubricating oils are commercially available in many forms for automotive, industrial, aircraft and other uses. Oils are classified as either petroleum types (refined from crude oil) or synthetic types (produced by chemical synthesis).

PETROLEUM OILS

Petroleum oils are made from a petroleum hydrocarbon derived from crude oil, with additives to improve certain properties. Petroleum oils are used for nearly all oil-lubricated applications of bearings.

SYNTHETIC OILS

Synthetic oils cover a broad range of categories and include polyalphaolefins, silicones, polyglycols and various esters. In general, synthetic oils are less prone to oxidation and can operate at extreme hot or cold temperatures. Physical properties, such as pressure-viscosity coefficients, tend to vary between oil types; use caution when making oil selections.

The polyalphaolefins (PAO) have a hydrocarbon chemistry that parallels petroleum oil both in chemical structures and pressure-viscosity coefficients. Therefore, PAO oil is mostly used in the oil-lubricated applications of bearings when severe temperature environments (hot and cold) are encountered or when extended lubricant life is required.

The silicone, ester and polyglycol oils have an oxygen-based chemistry that is structurally quite different from petroleum oils and PAO oils. This difference has a profound effect on its physical properties where pressure-viscosity coefficients can be lower compared to mineral and PAO oils. This means that these types of synthetic oils may actually generate a smaller elastohydrodynamic (EHD) film thickness than a mineral or PAO oil of equal viscosity at operating temperature. Reductions in bearing fatigue life and increases in bearing wear could result from this reduction of lubricant film thickness.

VISCOSITY

The selection of oil viscosity for any bearing application requires consideration of several factors: load, speed, bearing setting, type of oil and environmental factors. Since oil viscosity varies inversely with temperature, a viscosity value must always be stated with the temperature at which it was determined. High-viscosity oil is used for low-speed or high-ambient-temperature applications. Low-viscosity oil is used for high-speed or low-ambient-temperature applications.

There are several classifications of oils based on viscosity grades. The most familiar are the Society of Automotive Engineers (SAE) classifications for automotive engine and gear oils. The American Society for Testing and Materials (ASTM) and the International Organization for Standardization (ISO) have adopted standard viscosity grades for industrial fluids. Fig. 49 shows the viscosity comparisons of ISO/ASTM with SAE classification systems at 40° C (104° F).

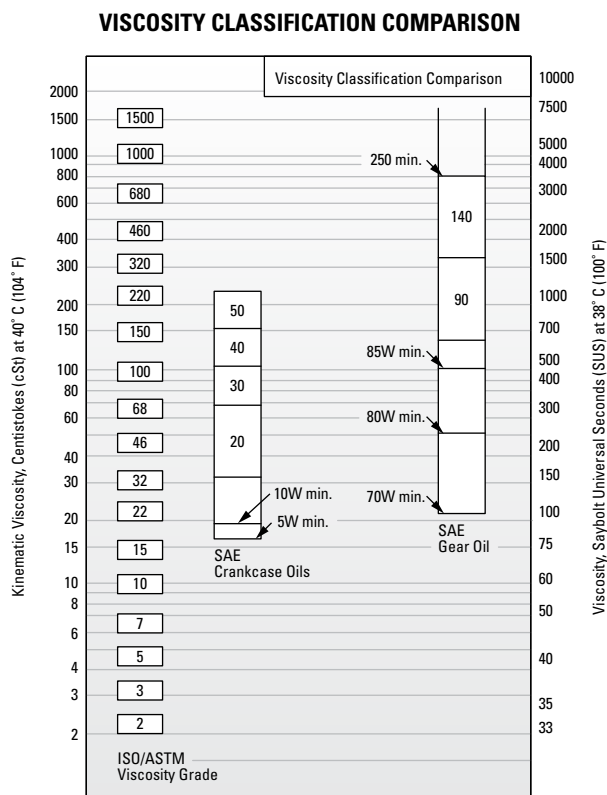

Fig. 49. Comparison between ISO/ASTM grades (ISO 3448/ASTM D2442) and SAE grades (SAE J 300-80 for crankcase oils, SAE J 306-81 for axle and manual transmission oils).

The ASTM/ISO viscosity grade system for industrial oils is depicted below.

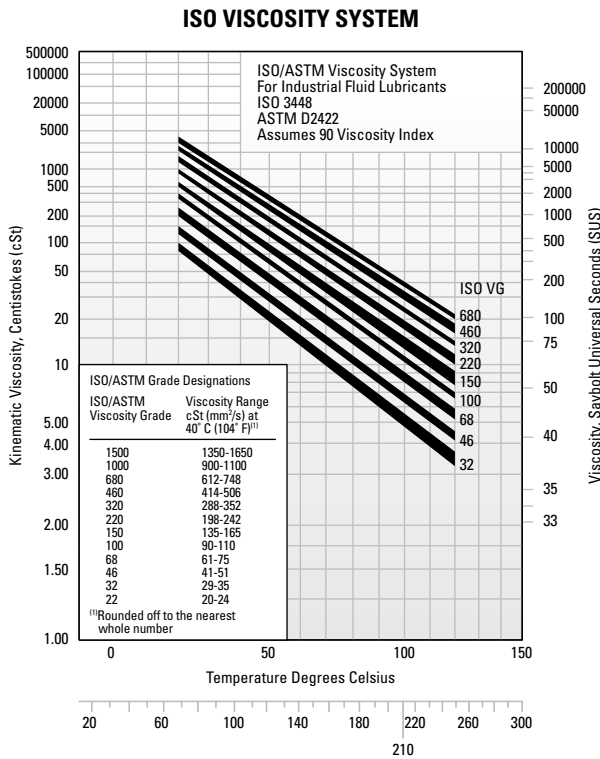

Fig. 50. Viscosity grade system for industrial oils.

TYPICAL BEARING LUBRICATION OILS

In this section, the properties and characteristics of lubricants for typical roller bearing applications are listed. These general characteristics are derived from successful performance in applications across all industries.

General-purpose rust and oxidation lubricating oil

General-purpose rust and oxidation (R&O) inhibited oils are the most common type of industrial lubricant. They are used to lubricate Timken® bearings in all types of industrial applications where conditions requiring special considerations do not exist.

TABLE 31. SUGGESTED GENERAL PURPOSE R&O LUBRICATING OIL PROPERTIES

| Properties | |
|------------------|---|
| Base stock | Solvent-refined, high-viscosity-index petroleum oil |
| Additives | Corrosion and oxidation inhibitors |
| Viscosity index | 80 min. |
| Pour point | -10° C max. (14° F) |
| Viscosity grades | ISO/ASTM 32 through 220 |

Some low-speed and/or high-ambient-temperature applications require the higher viscosity grades. High-speed and/or low-temperature applications require the lower viscosity grades.

Industrial extreme-pressure (EP) gear oil

Extreme-pressure gear oils are used to lubricate Timken bearings in most types of heavily loaded industrial equipment. They should be capable of withstanding abnormal shock loads that are common in heavy-duty equipment.

TABLE 32. SUGGESTED INDUSTRIAL EP GEAR OIL PROPERTIES

| Properties | |
|------------------|---|
| Base stock | Solvent-refined, high-viscosity-index petroleum oil |
| Additives | Corrosion and oxidation inhibitors Extreme-pressure (EP) additive ⁽¹⁾ - 15.8 kg (35 lb.) min. |
| Viscosity index | 80 min. |
| Pour point | -10° C max. (14° F) |
| Viscosity grades | ISO/ASTM 100, 150, 220, 320, 460 |

⁽¹⁾ ASTM D 2782

Industrial EP gear oils should be composed of a highly refined petroleum oil-based stock plus appropriate inhibitors and additives. They should not contain materials that are corrosive or abrasive to bearings. The inhibitors should provide long-term protection from oxidation and protect the bearing from corrosion in the presence of moisture. The oils should resist foaming in service and have good water-separation properties. An EP additive protects against scoring under boundary-lubrication conditions. The viscosity grades suggested represent a wide range. High-temperature and/or slow-speed applications generally require the higher viscosity grades. Low temperatures and/or high speeds require the use of lower viscosity grades.

GREASE LUBRICATION

Grease lubrication is generally applicable to low-to-moderate speed applications that have operating temperatures within the limits of the grease. There is no universal antifriction bearing grease. Each grease has limiting properties and characteristics.

Greases consist of a base oil, a thickening agent and additives. Conventionally, bearing greases have consisted of petroleum base oils thickened to the desired consistency by some form of metallic soap. More recently synthetic base oils have been used with organic and inorganic thickeners. Table 33 summarizes the composition of typical lubricating greases.

TABLE 33. COMPOSITION OF GREASES

| Base Oil | + | Thickening Agents | + | Additives | = | Lubricating Grease |
|-----------------------|---|------------------------------------|---|----------------------|---|--------------------|
| Mineral oil | | Soaps and complex soaps | | Rust inhibitors | | |
| Synthetic hydrocarbon | | lithium, aluminum, barium, calcium | | Dyes | | |
| Esters | | Non-Soap (inorganic) | | Tactifiers | | |
| Perfluorinated oil | | microgel (clay), carbon black, | | Metal deactivates | | |
| Silicone | | silica-gel, PTFE | | Oxidation inhibitors | | |
| | | Non-Soap (organic) | | Anti-wear EP | | |
| | | Polyurea compounds | | | | |

Calcium- and aluminum-based greases have excellent water resistance and are used in industrial applications where water ingress is an issue. Lithium-based greases are multi-purpose and are used in industrial applications and wheel bearings.

Synthetic-based oils such as esters, organic esters and silicones used with conventional thickeners and additives typically have higher maximum operating temperatures than petroleum-based greases. Synthetic greases can be designed to operate in temperatures from -73° C (-100° F) to 288° C (550° F).

Below are the general characteristics of common thickeners used with petroleum base oils.

TABLE 34. GENERAL CHARACTERISTICS OF THICKENERS USED WITH PETROLEUM BASE OILS

| Thickener | Typical Dropping Point | | Maximum Temperature | | Typical Water Resistance |
|-------------------|------------------------|------|---------------------|-----|--------------------------|
| | °C | °F | °C | °F | |
| Lithium soap | 193 | 380 | 121 | 250 | Good |
| Lithium complex | 260+ | 500+ | 149 | 300 | Good |
| Aluminum complex | 249 | 480 | 149 | 300 | Excellent |
| Calcium sulfonate | 299 | 570 | 177 | 350 | Excellent |
| Polyurea | 260 | 500 | 149 | 300 | Good |

Use of the thickeners in table 34 with synthetic hydrocarbon or ester base oils increases the maximum operating temperature by approximately 10° C (50° F).

Using polyurea as a thickener for lubricating fluids is one of the most significant lubrication developments in more than 30 years. Polyurea grease performance is outstanding in a wide range of bearing applications and, in a relatively short time, it has gained acceptance as a factory-packed lubricant for ball bearings.

LOW TEMPERATURES

Starting torque in a grease-lubricated bearing at low temperatures can be critical. Some greases may function adequately as long as the bearing is operating, but resistance to initial movement may be excessive. In certain smaller machines, starting may be impossible when very cold. Under such operating circumstances, greases containing low-temperature characteristic oils are generally required.

If the operating temperature range is wide, synthetic greases offer advantages. Synthetic greases are available to provide very low starting and running torque at temperatures as low as -73° C (-100° F). In certain instances, these greases perform better in this respect than oil.

An important point concerning lubricating greases is that the starting torque is not necessarily a function of the consistency or the channel properties of the grease. Starting torque is more a function of the individual rheological properties of a particular grease and is best evaluated by application experience.

HIGH TEMPERATURES

The high temperature limit for lubricating greases is generally a function of the thermal and oxidation stability of the fluid and the effectiveness of the oxidation inhibitors. Grease temperature ranges are defined by both the dropping point of the grease thickener and composition of the base oil. Table 35 shows the temperature ranges of various base oils used in grease formulations.

A rule of thumb, developed from years of testing grease-lubricated bearings, indicates that grease life is halved for every 10° C (50° F) increase in temperature. For example, if a particular grease provides 2000 hours of life at 90° C (194° F), by raising the temperature to 100° C (212° F), reduction in life to approximately 1000 hours would result. On the other hand, 4000 hours could be expected by lowering the temperature to 80° C (176° F).

Thermal stability, oxidation resistance and temperature limitations must be considered when selecting greases for high-temperature applications. In non-relubricatable applications, highly refined mineral oils or chemically stable synthetic fluids are required as the oil component of greases for operation at temperatures above 121° C (250° F).

TABLE 35. TEMPERATURE RANGES FOR BASE OILS USED IN LUBRICATING GREASES

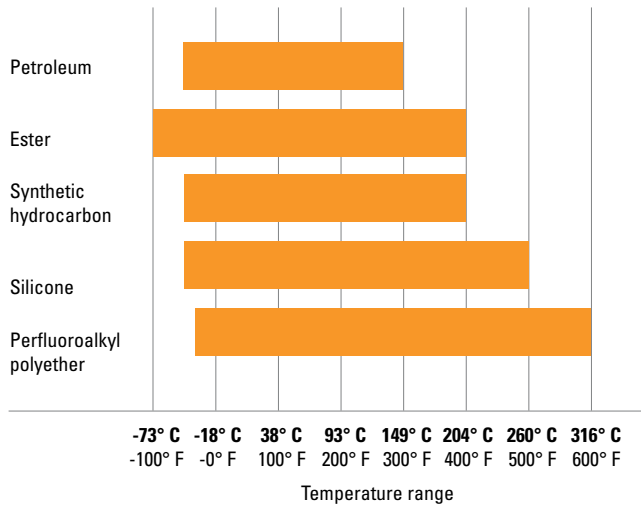

CONTAMINATION

Abrasive Particles

When roller bearings operate in a clean environment, the primary cause of damage is the eventual fatigue of the surfaces where rolling contact occurs. However, when particle contamination enters the bearing system, it is likely to cause damage such as bruising, which can shorten bearing life.

When dirt from the environment or metallic wear debris from some component in the application is allowed to contaminate the lubricant, wear can become the predominant cause of bearing damage. If bearing wear becomes significant, changes will occur to critical bearing dimensions that could adversely affect machine operation.

Bearings operating in a contaminated lubricant exhibit a higher initial rate of wear than those running in an uncontaminated lubricant. With no further contaminant ingress, this wear rate quickly diminishes. The contamination particles are reduced in size as they pass through the bearing contact area during normal operation.

Water

Water and moisture can be particularly conducive to bearing damage. Lubricating greases may provide a measure of protection from this contamination. Certain greases, such as calcium and aluminum-complex, are highly water-resistant.

Sodium-soap greases are water-soluble and should not be used in applications involving water.

Dissolved or suspended water in lubricating oils can exert a detrimental influence on bearing fatigue life. Water can cause bearing etching that also can reduce bearing fatigue life. The exact mechanism by which water lowers fatigue life is not fully understood. It has been suggested that water enters micro-cracks in the bearing rings that are caused by repeated stress cycles. This leads to corrosion and hydrogen embrittlement in the micro-cracks, reducing the time required for these cracks to propagate to an unacceptable-sized spall.

Water-based fluids, such as water glycol and invert emulsions, also have shown a reduction in bearing fatigue life. Although water from these sources is not the same as contamination, the results support the previous discussion concerning water-contaminated lubricants.

GREASE SELECTION

The successful use of bearing grease depends on the physical and chemical properties of the lubricant as well as application and environmental conditions. Because the choice of grease for a particular bearing under certain service conditions is often difficult to make, you should consult with your lubricant supplier or equipment maker for specific questions about lubrication requirements for your application. You also can contact your Timken engineer for general lubrication guidelines for any application.

Grease must be carefully selected with regard to its consistency at operating temperature. It should not exhibit thickening, separation of oil, acid formation or hardening to any marked degree. It should be smooth, non-fibrous and entirely free from chemically active ingredients. Its dropping point should be considerably higher than the operating temperature.

Timken® application-specific lubricants were developed by leveraging our knowledge of tribology and anti-friction bearings, and how these two elements affect overall system performance. Timken® lubricants help bearings and related components operate effectively in demanding industrial operations. High-temperature, anti-wear and water-resistant additives offer superior protection in challenging environments. Table 36 provides an overview of the Timken greases available for general applications. Contact your Timken engineer for a more detailed publication on Timken® lubrication solutions.

TABLE 36. GREASE LUBRICATION SELECTION GUIDE

| ENVIRONMENT | | APPLICATION |
|--|---|--|
| High Wear • Moderate Loads Moderate Speeds Moderate Temperatures | → | ← |
| | Timken Premium All-Purpose Industrial Grease | Agriculture • Bushings/Ball Joints Truck and Auto Wheel Bearings Heavy-Duty Industrial |
| Extreme Heat • Heavy Loads High Sliding Wear Dirty Environments Slow Speeds • Shock Loading | → | ← |
| | Timken Construction and Off-Highway Grease | Agriculture/Mining • Cement Plants Construction/Off Road • Rock Quarry Earth-Moving Equipment Fleet Equipment • Heavy Industry Pivot Pins/Splined Shafts |
| Wet and Corrosive Conditions Quiet Environments • Light Loads Moderate to High Speeds Moderate Temperatures Light Load Moderate Water | → | ← |
| | Timken Ball Bearing Pillow Block Grease | Lightly Loaded Pillow Blocks Idler Pulleys • Oven Conveyors Electric Motors • Fans • Pumps Alternators • Generators |
| Corrosive Media • Extreme Heat Heavy Loads • Wet Conditions Slow to Moderate Speeds | → | ← |
| | Timken Mill Grease | Aluminum Mills • Paper Mills Steel Mills • Offshore Rigs Power Generation |
| Incidental Food Contact Hot and Cold Temperatures Moderate to High Speeds Medium Loads | → | ← |
| | Timken Food Safe Grease | Food and Beverage Industries Pharmaceuticals |
| Extreme Low and High Temperatures Severe Loads Corrosive Media Slow to Moderate Speeds | → | ← |
| | Timken Synthetic Industrial Grease | Wind Energy Main Bearing Pulp and Paper Machines General Heavy Industry Marine Applications Centralized Grease Systems |
| Moderate Speeds Light to Moderate Loads Moderate Temperatures Moderate Water | → | ← |
| | Timken Multi-Use Lithium Grease | General Industrial Applications Pins and Bushings • Track Rollers Water Pumps Plain and Anti-Friction Bearings |

This selection guide is not intended to replace the specifications by the equipment builder, who is responsible for its performance.

Many bearing applications require lubricants with special properties or lubricants formulated specifically for certain environments, such as:

- Friction oxidation (fretting corrosion).
- Chemical and solvent resistance.
- Food handling.
- Quiet running.
- Space and/or vacuum.
- Electrical conductivity.

For assistance with these or other areas requiring special lubricants, consult your Timken engineer.

GREASE USE GUIDELINES

It is important to use the proper amount of grease in the application. In typical industrial applications, the bearing cavity should be kept approximately one-third to one-half full. Less grease may result in the bearing being starved for lubrication. More grease may result in churning. Both conditions may result in excessive temperature. As the grease temperature rises, viscosity decreases and the grease becomes thinner. This can reduce the lubricating effect and increase leakage of the grease from the bearing. It also may cause the grease components to separate, leading to a general breakdown of the lubricant properties. As the grease breaks down, bearing torque increases. In the case of excess grease resulting in churning, torque may also increase due to the resistance caused by the grease.

For best results, there should be ample space in the housing to allow room for excess grease to be thrown from the bearing. However, it is equally important that the grease be retained all around the bearing. If a large void exists between the bearings, grease closures should be used to prevent the grease from leaving the bearing area.

Only in low-speed applications may the housing be entirely filled with grease. This method of lubrication is a safeguard against the entry of foreign matter, where sealing provisions are inadequate for exclusion of contaminants or moisture.

During periods of non-operation, it is often wise to completely fill the housings with grease to protect the bearing surfaces. Prior to restarting operation, remove the excess grease and restore the proper level.

Applications utilizing grease lubrication should have a grease fitting and a vent at opposite ends of the housing near the top. A drain plug should be located near the bottom of the housing to allow the old grease to purge from the bearing.

Bearings should be relubricated at regular intervals to prevent damage. Relubrication intervals are difficult to determine. If plant practice or experience with other applications is not available, consult your lubricant supplier.

Timken offers a range of lubricants to help bearings and related components operate effectively in demanding industrial operations. High-temperature, anti-wear and water-resistant additives offer greater protection in challenging environments. Timken also offers a line of single- and multi-point lubricators to simplify grease delivery.



Fig. 51. Grease can easily be packed by hand.



Fig. 52. Mechanical grease packer.

Grease application methods

Grease, in general, is easier to use than oil in industrial bearing lubrication applications. Most bearings that are initially packed with grease require periodic relubrication to operate efficiently.

Grease should be packed into the bearing so that it gets between the rolling elements – the rollers or balls. For tapered roller bearings, forcing grease through the bearing from the large end to the small end will ensure proper distribution.

Grease can be easily packed into small- and medium-size bearings by hand (fig. 51). In shops where bearings are frequently regreased, a mechanical grease packer that forces grease through the bearing under pressure may be appropriate (fig. 52). Regardless of the method, after packing the internal areas of the bearing, a small amount of grease also should be smeared on the outside of the rollers or balls.

The two primary considerations that determine the relubrication cycle are operating temperature and sealing efficiency. High-operating-temperature applications generally require more frequent regreasing. The less efficient the seals, the greater the grease loss and the more frequently grease must be added.

Grease should be added any time the amount in the bearing falls below the desired amount. The grease should be replaced when its lubrication properties have been reduced through contamination, high temperature, water, oxidation or any other factors. For additional information on appropriate regreasing cycles, consult with the equipment manufacturer or your Timken engineer.

CONSISTENCY

Greases may vary in consistency from semi-fluids that are hardly thicker than a viscous oil to solid grades almost as hard as a soft wood.

Consistency is measured by a penetrometer in which a standard weighted cone is dropped into the grease. The distance the cone penetrates (measured in tenths of a millimeter in a specific time) is the penetration number.

The National Lubricating Grease Institute (NLGI) classification of grease consistency is shown below:

TABLE 37. NLGI CLASSIFICATIONS

| NLGI Grease Grades | Penetration Number |
|--------------------|--------------------|
| 0 | 355-385 |
| 1 | 310-340 |
| 2 | 265-295 |
| 3 | 220-250 |
| 4 | 175-205 |
| 5 | 130-160 |
| 6 | 85-115 |

Grease consistency is not fixed; it normally becomes softer when sheared or “worked.” In the laboratory, this “working” is accomplished by forcing a perforated plate up and down through a closed container of grease. This “working” does not compare with the violent shearing action that takes place in a bearing and does not necessarily correlate with actual performance.

TABLE 38. GREASE COMPATIBILITY CHART

| | Al Complex | Ba Complex | Ca Stearate | Ca 12 Hydroxy | Ca Complex | Ca Sulfonate | Clay Non-Soap | Li Stearate | Li 12 Hydroxy | Li Complex | Polyurea | Polyurea S S |
|---|--------------|--------------|--------------|---------------|--------------|--------------|---------------|--------------|---------------|--------------|--------------|--------------|
| Aluminum Complex | Best Choice | Incompatible | Incompatible | Compatible | Incompatible | Borderline | Incompatible | Incompatible | Incompatible | Compatible | Incompatible | Compatible |
| Timken Food Safe | Best Choice | Incompatible | Incompatible | Compatible | Incompatible | Borderline | Incompatible | Incompatible | Incompatible | Compatible | Incompatible | Compatible |
| Barium Complex | Incompatible | Best Choice | Incompatible | Compatible | Compatible | Compatible | Incompatible | Incompatible | Incompatible | Incompatible | Incompatible | Borderline |
| Calcium Stearate | Incompatible | Incompatible | Best Choice | Compatible | Incompatible | Compatible | Compatible | Compatible | Borderline | Compatible | Incompatible | Compatible |
| Calcium 12 Hydroxy | Compatible | Compatible | Compatible | Best Choice | Borderline | Borderline | Compatible | Compatible | Compatible | Compatible | Incompatible | Compatible |
| Calcium Complex | Incompatible | Incompatible | Incompatible | Borderline | Best Choice | Incompatible | Incompatible | Incompatible | Incompatible | Compatible | Compatible | Compatible |
| Calcium Sulfonate | Borderline | Compatible | Compatible | Borderline | Incompatible | Best Choice | Incompatible | Borderline | Borderline | Compatible | Incompatible | Compatible |
| Timken Premium Mill Timken Heavy-Duty Moly | Borderline | Compatible | Compatible | Borderline | Incompatible | Best Choice | Incompatible | Borderline | Borderline | Compatible | Incompatible | Compatible |
| Clay Non-Soap | Incompatible | Incompatible | Compatible | Compatible | Incompatible | Incompatible | Best Choice | Incompatible | Incompatible | Incompatible | Incompatible | Borderline |
| Lithium Stearate | Incompatible | Incompatible | Compatible | Compatible | Borderline | Incompatible | Incompatible | Best Choice | Compatible | Compatible | Incompatible | Compatible |
| Lithium 12 Hydroxy | Incompatible | Incompatible | Borderline | Compatible | Incompatible | Borderline | Incompatible | Compatible | Incompatible | Best Choice | Incompatible | Compatible |
| Lithium Complex | Compatible | Incompatible | Compatible | Compatible | Compatible | Compatible | Incompatible | Compatible | Compatible | Incompatible | Incompatible | Compatible |
| Polyurea Conventional | Incompatible | Incompatible | Incompatible | Incompatible | Compatible | Incompatible | Incompatible | Incompatible | Incompatible | Incompatible | Best Choice | Compatible |
| Polyurea Shear Stable | Compatible | Borderline | Compatible | Compatible | Compatible | Compatible | Borderline | Compatible | Compatible | Compatible | Compatible | Best Choice |
| Timken Multi-Use | Incompatible | Incompatible | Borderline | Compatible | Incompatible | Borderline | Incompatible | Compatible | Best Choice | Compatible | Incompatible | Compatible |
| Timken All-Purpose Timken Synthetic | Compatible | Incompatible | Compatible | Compatible | Compatible | Compatible | Incompatible | Compatible | Compatible | Best Choice | Incompatible | Compatible |
| Timken Pillow Block | Compatible | Borderline | Compatible | Compatible | Compatible | Compatible | Borderline | Compatible | Compatible | Compatible | Compatible | Best Choice |

NOTE

Mixing greases can result in improper bearing lubrication.
Always follow the specific lubrication instructions of your equipment supplier.

BEARING DATA

The following topics are covered within this section:

| | |
|---|-----|
| Nomenclature..... | 66 |
| Angular Contact Thrust Ball Bearings | 69 |
| Type TVL..... | 69 |
| Type DTVL..... | 73 |
| Thrust Cylindrical Roller Bearings | 75 |
| Type TP..... | 75 |
| Type TPS | 81 |
| Thrust Spherical Roller Bearings..... | 85 |
| Type TSR-EJ and TSR-EM..... | 85 |
| Thrust Tapered Roller Bearings..... | 93 |
| Type TTHD | 93 |
| Type TTHDFL | 99 |
| Type TTHDFLSA | 105 |
| Types TTSP, TTSPS and TTSPSPL | 107 |
| Types TTC, TTCS and TTCL | 111 |
| Screwdown Bearings – Types TTHDSX/SV and TTHDFLSX/SV | 117 |
| Types TTDWK and TTDFLK | 127 |
| Crossed Roller Bearings Type TXR..... | 135 |

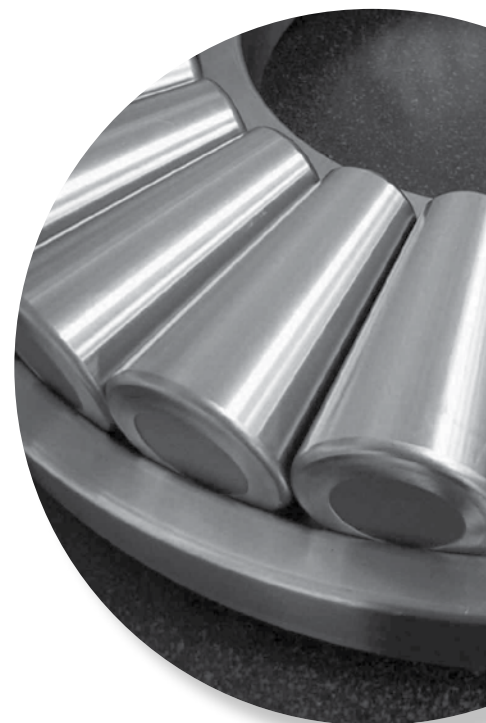

NOMENCLATURE

THRUST BALL, CYLINDRICAL AND TAPERED SCREWDOWN BEARINGS

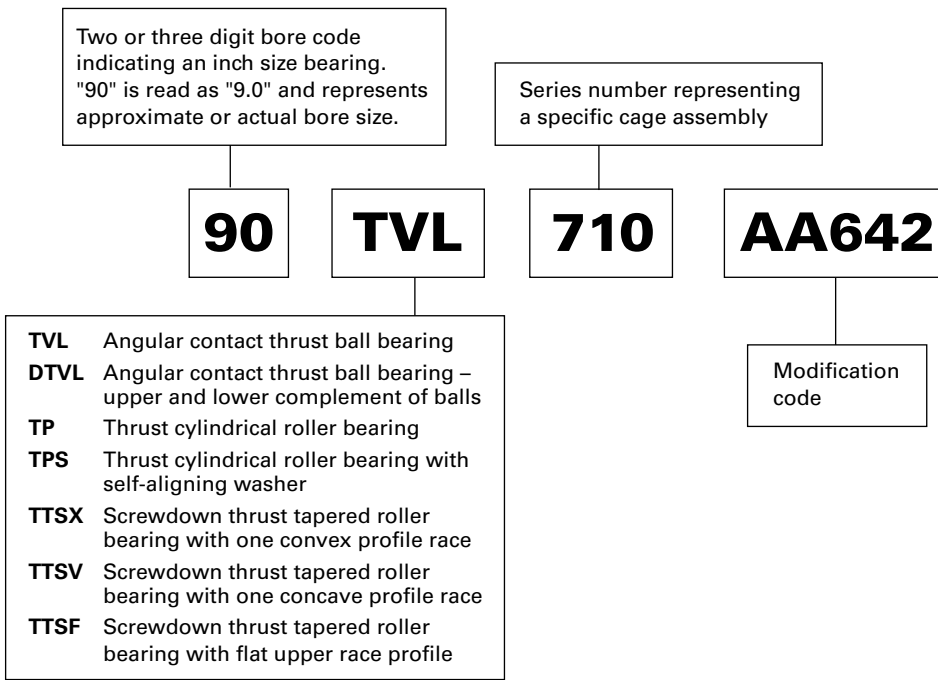

Fig. 53. Thrust ball, cylindrical and tapered screwdown bearings nomenclature.

THRUST SPHERICAL ROLLER BEARINGS

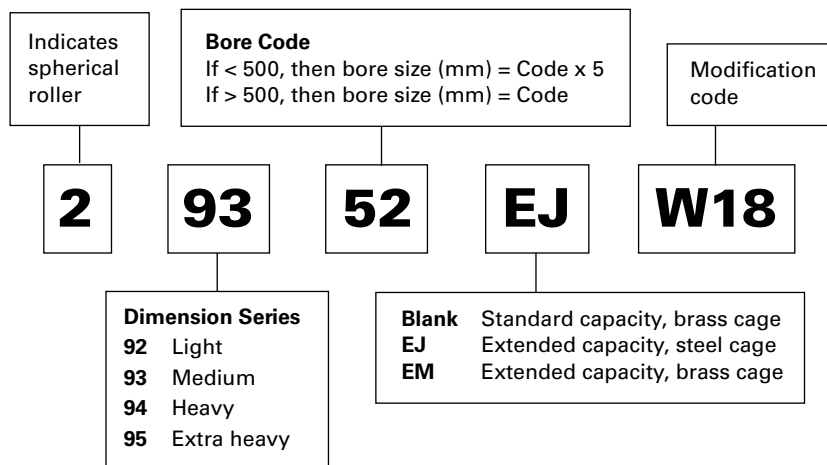

Fig. 54. Thrust spherical roller bearings nomenclature.

STANDARD THRUST TAPERED ROLLER BEARINGS

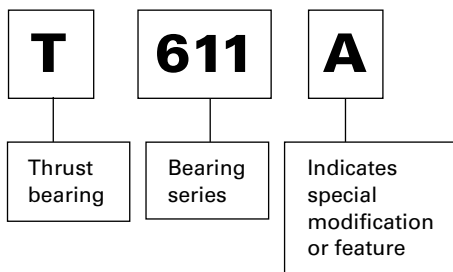

Fig. 55. Standard thrust tapered roller bearings nomenclature.

CROSSED ROLLER BEARINGS

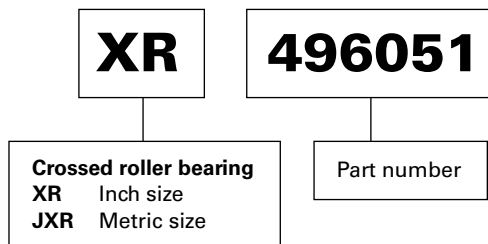

Fig. 56. Crossed roller bearings nomenclature.

SPECIAL PART NUMBERS

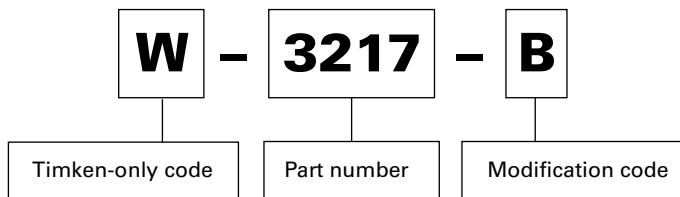

Fig. 57. Special part numbers nomenclature.

ANGULAR CONTACT THRUST BALL BEARINGS

TYPE TVL

- Single-row angular contact construction.
- Provides exceptionally low friction, cool running and quiet operation when operated at high speeds.
- Accommodates axial loads as well as moderate radial loads.

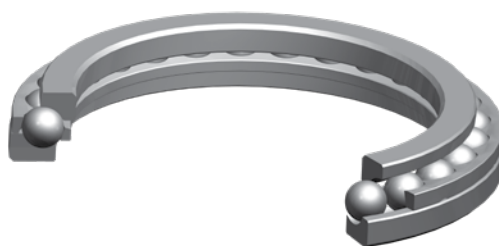
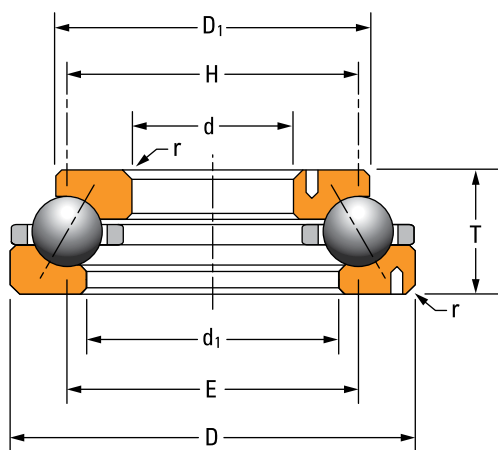

Fig. 58. Type TVL angular contact thrust ball bearing.



OVERALL DIMENSIONS:

- d – Bore diameter
- D – Bearing O.D.
- T – Bearing width
- d₁ – Large ring I.D.
- D₁ – Small ring O.D.
- E – Housing shoulder diameter
- H – Shaft shoulder diameter
- r – Shaft/housing maximum fillet radius

Fig. 59. Type TVL angular contact thrust ball bearing assembly.

THRUST BEARING DATA

ANGULAR-CONTACT THRUST BALL BEARING – TYPE TVL

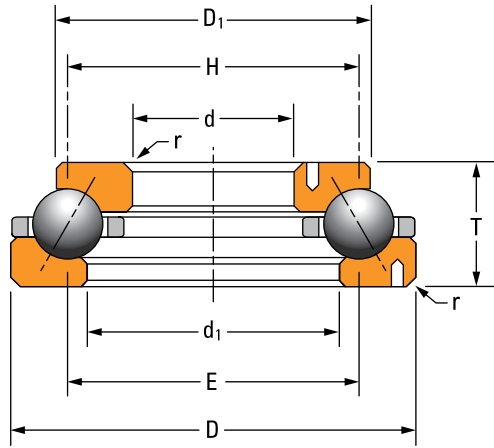
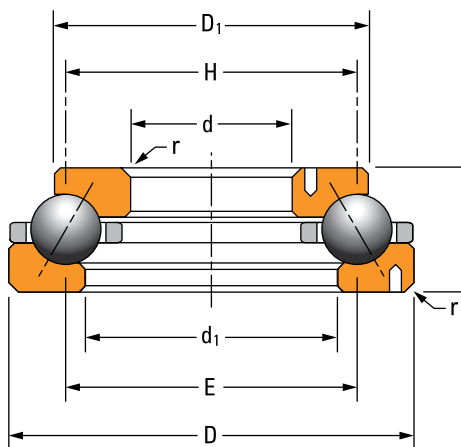

TABLE 39. ANGULAR CONTACT THRUST BALL BEARING PRODUCT DATA – TYPE TVL

| Bearing Number | Bearing Dimensions | | | Rings | | Shoulder Diameter | | Dowel Pin (One Per Ring) | | | Fillet ⁽¹⁾ Radius (Max.) | Load Rating | | Bearing Weight |
|----------------|--------------------|--------------------|-------------------|---------------------|------------------|-------------------|----------------|--------------------------|-------------------------------|-----------------|-------------------------------------|--------------------|---------------------|----------------|
| | Bore | O.D. | Width | Small Diameter O.D. | Large Bore I.D. | Shaft (Min.) | Housing (Max.) | Pin Dia. | Hole Location from Centerline | | | Static Load Rating | Dynamic Load Rating | |
| | d | D | T | D_1 | d_1 | H | E | | Small Bore Ring | Large Bore Ring | r | C_{a0} | C_a | |
| | mm in. | mm in. | mm in. | mm in. | mm in. | mm in. | mm in. | mm in. | mm in. | mm in. | mm in. | kN lbf. | kN lbf. | kg lbs. |
| 90TVL710 | 228.600 9.0000 | 295.275 11.6250 | 38.100 1.5000 | 277.81 10.938 | 246.06 9.688 | 261.9 10.31 | 261.9 10.31 | – – | – – | – – | 3.2 0.12 | 480 108260 | 140 32070 | 6.2 13.6 |
| 120TVL700 | 304.800 12.0000 | 406.400 16.0000 | 57.150 2.2500 | 368.30 14.500 | 342.90 13.500 | 355.6 14.00 | 355.6 14.00 | 9.5 0.38 | 165.1 6.50 | 190.5 7.50 | 3.2 0.12 | 1370 306810 | 350 78660 | 18.5 40.8 |
| 150TVL701 | 381.000 15.0000 | 520.700 20.5000 | 84.125 3.3120 | 482.60 19.000 | 419.10 16.500 | 450.8 17.75 | 450.8 17.75 | 12.7 0.50 | 206.4 8.12 | 244.5 9.62 | 4.8 0.19 | 2300 517800 | 510 114270 | 50.2 110.7 |
| 170TVL500 | 431.800 17.0000 | 635.000 25.0000 | 88.900 3.5000 | 565.15 22.250 | 488.95 19.250 | 533.4 21.00 | 533.4 21.00 | 12.7 0.50 | 235.0 9.25 | 298.4 11.75 | 7.9 0.31 | 3250 729730 | 660 149160 | 89.6 197.5 |
| 180TVL605 | 457.200 18.0000 | 625.475 24.6250 | 92.075 3.6250 | 549.28 21.625 | 508.00 20.000 | 541.3 21.31 | 541.3 21.31 | 15.9 0.63 | 247.6 9.75 | 285.8 11.25 | 3.2 0.12 | 3510 788300 | 730 163720 | 78.4 172.9 |
| 195TVL470 | 495.300 19.5000 | 584.200 23.0000 | 57.150 2.2500 | 571.50 22.500 | 508.00 20.000 | 539.8 21.25 | 539.8 21.25 | 9.5 0.38 | 258.8 10.19 | 281.0 11.06 | 3.2 0.12 | 1990 446550 | 400 89490 | 28.4 62.7 |
| 200TVL850 | 508.000 20.0000 | 704.850 27.7500 | 117.475 4.6250 | 628.68 24.750 | 565.15 22.250 | 606.4 23.88 | 606.4 23.88 | 15.9 0.63 | 276.2 10.88 | 330.2 13.00 | 6.4 0.25 | 3830 859870 | 750 167720 | 127.3 280.7 |
| 201TVL615 | 511.175 20.1250 | 628.650 24.7500 | 66.675 2.6250 | 590.55 23.250 | 549.28 21.625 | 569.9 22.44 | 569.9 22.44 | 12.7 0.50 | 268.3 10.56 | 300.0 11.81 | 3.2 0.12 | 2520 566060 | 490 110380 | 41.9 92.3 |
| 202TVL620 | 514.350 20.5000 | 704.850 27.7500 | 114.300 4.5000 | 622.30 24.500 | 571.50 22.500 | 609.6 24.00 | 609.6 24.00 | 20.6 0.81 | 279.4 11.00 | 327.0 12.88 | 6.4 0.25 | 4340 974600 | 840 189020 | 122.3 269.7 |
| 227TVL302 | 577.850 22.7500 | 774.700 30.5000 | 117.475 4.6250 | 704.85 27.750 | 622.30 24.500 | 676.3 26.62 | 676.3 26.62 | 20.6 0.81 | 311.2 12.25 | 365.1 14.38 | 6.4 0.25 | 4900 1102440 | 880 198370 | 149.8 330.2 |
| 233TVL303 | 593.725 23.3750 | 790.575 31.1250 | 117.475 4.6250 | 720.72 28.375 | 650.88 25.625 | 692.2 27.25 | 692.2 27.25 | 22.2 0.88 | 320.7 12.62 | 369.9 14.56 | 6.4 0.25 | 5090 1143430 | 900 202060 | 150.7 332.2 |
| 238TVL304 | 606.425 23.8750 | 847.725 35.3950 | 133.350 5.2500 | 739.78 29.125 | 688.98 27.125 | 727.1 28.62 | 727.1 28.62 | 22.2 0.88 | 327.0 12.88 | 396.9 15.62 | 6.4 0.25 | 6240 1403430 | 1090 243980 | 212.6 468.7 |
| 245TVL716 | 622.300 24.5000 | 768.350 30.2500 | 82.550 3.2500 | 733.42 28.875 | 680.47 26.790 | 695.3 27.38 | 695.3 27.38 | 12.7 0.50 | 323.8 12.75 | 371.5 14.62 | 3.2 0.12 | 2940 660340 | 510 114390 | 76.2 168.0 |
| 245TVL612 | 622.300 24.5000 | 831.850 32.7500 | 117.475 4.6250 | 742.95 29.250 | 679.45 26.750 | 727.1 28.62 | 727.1 28.62 | 15.9 0.63 | 330.2 13.00 | 396.9 15.62 | 6.4 0.25 | 5280 1187860 | 910 203680 | 164.5 362.7 |

⁽¹⁾Maximum shaft or housing fillet radius that bearing corners will clear.

Continued on next page.



Continued from previous page.

| Bearing Number | Bearing Dimensions | | | Rings | | Shoulder Diameter | | Dowel Pin (One Per Ring) | | | Fillet ⁽¹⁾ Radius (Max.) | Load Rating | | Bearing Weight |
|----------------|---------------------|---------------------|-------------------|---------------------|-------------------|-------------------|-----------------|--------------------------|-------------------------------|-----------------|-------------------------------------|--------------------|---------------------|-----------------|
| | Bore | O.D. | Width | Small Diameter O.D. | Large Bore I.D. | Shaft (Min.) | Housing (Max.) | Pin Dia. | Hole Location from Centerline | | | Static Load Rating | Dynamic Load Rating | |
| | d | D | T | D ₁ | d ₁ | H | E | | Small Bore Ring | Large Bore Ring | r | C _{a0} | C _a | |
| | mm in. | mm in. | mm in. | mm in. | mm in. | mm in. | mm in. | mm in. | mm in. | mm in. | mm in. | kN lbf. | kN lbf. | kg lbs. |
| 252TVL505 | 341.350 25.2500 | 793.750 31.2500 | 88.900 3.5000 | 746.12 29.375 | 708.02 27.875 | 717.6 28.25 | 717.6 28.25 | 12.7 0.50 | 342.9 13.50 | 376.2 14.81 | 6.4 0.25 | 4120 925070 | 710 159440 | 89.3 197.0 |
| 260TVL635 | 660.400 26.0000 | 893.350 35.2500 | 133.350 5.2500 | 790.58 31.125 | 727.08 28.625 | 777.9 30.62 | 777.9 30.62 | 20.6 0.81 | 355.6 14.00 | 422.3 16.62 | 6.4 0.25 | 7030 1580800 | 1150 259090 | 226.9 500.4 |
| 302TVL510 | 768.350 30.2500 | 920.750 36.2500 | 88.900 3.5000 | 873.12 34.375 | 835.02 32.875 | 844.6 33.25 | 844.6 33.25 | 12.7 0.50 | 408.0 16.06 | 439.7 17.31 | 6.4 0.25 | 4850 1089700 | 750 168910 | 105.2 231.9 |
| 302TVL624 | 768.350 30.2500 | 1006.475 39.6250 | 139.700 5.5000 | 901.70 35.500 | 838.20 33.000 | 887.4 34.94 | 887.4 34.94 | 22.2 0.88 | 409.6 16.12 | 476.2 18.75 | 6.4 0.25 | 7870 1770010 | 1190 267400 | 271.1 597.8 |
| 303TVL706 | 771.525 30.3750 | 898.525 35.3750 | 63.500 2.5000 | 860.42 33.875 | 809.62 31.875 | 835.0 32.88 | 835.0 32.88 | 12.7 0.50 | 403.2 15.88 | 431.8 17.00 | 6.4 0.25 | 3040 682650 | 460 102250 | 58.0 128.0 |
| 309TVL707 | 785.812 30.9375 | 952.500 37.5000 | 95.250 3.7500 | 882.65 34.750 | 857.25 33.750 | 870.0 34.25 | 870.0 34.25 | 15.9 0.63 | 415.9 16.38 | 454.0 17.88 | 6.4 0.25 | 3240 727460 | 570 127850 | 117.9 260.0 |
| 310TVL625 | 787.400 31.0000 | 1025.525 40.3750 | 139.700 5.5000 | 917.58 36.125 | 893.76 35.188 | 906.5 35.69 | 906.5 35.69 | 22.2 0.88 | 422.3 16.62 | 485.8 19.12 | 6.4 0.25 | 8140 1829670 | 1210 271790 | 263.5 581.0 |
| 317TVL307 | 806.450 31.7500 | 1025.525 40.3750 | 127.000 5.0000 | 933.45 36.750 | 873.12 34.375 | 914.4 36.00 | 914.4 36.00 | 22.2 0.88 | 427.0 16.81 | 476.2 18.75 | 6.4 0.25 | 8140 1829670 | 1210 271790 | 240.6 530.6 |
| 402TVL717 | 1022.350 40.2500 | 1181.100 46.5000 | 88.900 3.5000 | 1133.48 44.625 | 1069.98 42.125 | 1101.7 43.38 | 1101.7 43.38 | 19.1 0.75 | 530.2 20.88 | 571.5 22.50 | 6.4 0.25 | 6310 1418330 | 820 185160 | 147.8 326.0 |
| 410TVL718 | 1041.400 41.0000 | 1260.475 49.6250 | 127.000 5.0000 | 1189.04 46.812 | 1112.84 43.812 | 1150.9 45.31 | 1150.9 45.31 | 19.1 0.75 | 544.5 21.44 | 606.4 23.88 | 6.4 0.25 | 10590 2380340 | 1340 301160 | 308.8 681.0 |
| 420TVL721 | 1066.800 42.0000 | 1285.875 50.6250 | 127.000 5.0000 | 1214.44 47.812 | 1138.24 44.812 | 1176.3 46.31 | 1176.3 46.31 | 22.2 0.88 | 560.4 22.06 | 616.0 24.25 | 6.4 0.25 | 10600 2383620 | 1330 299290 | 315.2 695.0 |
| 530TVL719 | 1346.200 53.0000 | 1517.650 59.7500 | 104.775 4.1250 | 1457.32 57.375 | 1406.52 55.375 | 1431.9 56.38 | 1431.9 56.38 | 22.2 0.88 | 695.3 27.38 | 733.4 28.88 | 6.4 0.25 | 7080 1590850 | 810 183060 | 230.0 506.0 |
| 540TVL720 | 1371.600 54.0000 | 1619.250 63.7500 | 139.700 5.5000 | 1533.52 60.375 | 1457.32 57.375 | 1495.4 58.88 | 1495.4 58.88 | 22.2 0.88 | 714.4 28.12 | 781.0 30.75 | 6.4 0.25 | 13880 3119420 | 1470 331050 | 480.3 1059.0 |

⁽¹⁾Maximum shaft or housing fillet radius that bearing corners will clear.

TYPE DTVL

- Double-row angular contact construction.
- Designed to accommodate high axial loads in one direction, a lighter axial load in the opposite direction, as well as moderate radial loads.
- Compact design which is ideal for applications where not enough space is available for two TVL bearings.



Fig. 60. Type DTVL angular contact thrust ball bearing.

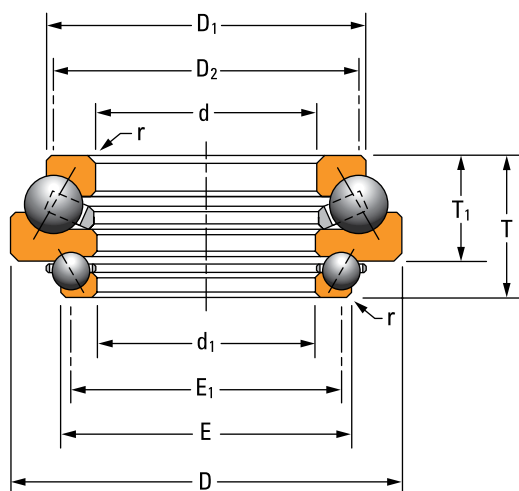

OVERALL DIMENSIONS:

- d – Upper bore diameter
- d₁ – Lower bore diameter
- D – Bearing O.D.
- T – Overall bearing width
- D₁ – Upper race O.D.
- E – Lower race O.D.
- D₂ – Upper race shaft shoulder diameter
- E₁ – Lower race shaft shoulder diameter
- T₁ – Upper bearing width
- r – Shaft/housing maximum fillet radius

Fig. 61. Type DTVL angular contact thrust ball bearing assembly.

THRUST BEARING DATA

ANGULAR CONTACT THRUST BALL BEARING – TYPE DTVL

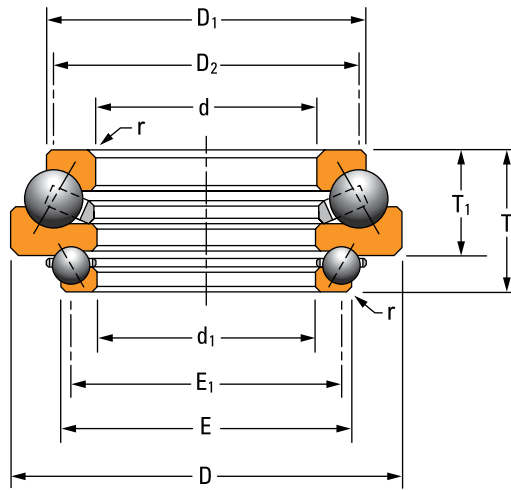

TABLE 40. ANGULAR CONTACT THRUST BALL BEARING PRODUCT DATA – TYPE DTVL

| Bearing Number | Bearing Dimensions | | | | Upper Race | | Lower Race | | Fillet ⁽¹⁾ Radius (Max.) | r | Load Rating | | | Bearing Weight |
|----------------|---------------------|---------------------|---------------------|--------------------|-------------------|-------------------|-------------------|-------------------|-------------------------------------|-------------|--------------------------|---------------------------|--------------------------|------------------|
| | Upper Bore | Lower Bore | O.D. | Width | O.D. | Shoulder | O.D. | Shoulder | | | Upper Static Load Rating | Upper Dynamic Load Rating | Lower Static Load Rating | |
| | d | d ₁ | D | T | D ₁ | D ₂ | E | E ₁ | | | C _{a0} | C _a | C _{a0} | |
| | mm in. | mm in. | mm in. | mm in. | mm in. | mm in. | mm in. | mm in. | mm in. | kN lbf. | kN lbf. | kN lbf. | kg lbs. | |
| 200DTV1722 | 508.000 20.0000 | 508.000 20.0000 | 742.950 29.2500 | 171.450 6.7500 | 679.45 26.750 | 616.00 24.250 | 587.38 23.125 | 558.80 22.000 | 127.00 5.000 | 6.4 0.25 | 4000 898500 | 790 177530 | 2730 613750 | 177.3 391.0 |
| 202DTV1723 | 514.350 20.2500 | 511.175 20.1250 | 704.850 27.7500 | 158.750 6.2500 | 622.30 24.500 | 609.60 24.000 | 590.55 23.250 | 569.90 22.440 | 114.30 4.500 | 6.4 0.25 | 3990 896630 | 800 178800 | 2890 648750 | 133.3 294.0 |
| 235DTV1724 | 596.900 23.5000 | 590.550 23.2500 | 838.200 33.0000 | 184.150 7.2500 | 774.70 30.500 | 711.20 28.000 | 676.28 26.625 | 647.70 25.500 | 139.70 5.500 | 6.4 0.25 | 5280 1186240 | 940 212230 | 3460 777590 | 246.2 543.0 |
| 245DTV1725 | 622.300 24.5000 | 619.125 24.3750 | 815.975 32.1250 | 158.750 6.2500 | 730.25 28.750 | 717.60 28.250 | 698.50 27.500 | 677.90 26.680 | 114.30 4.500 | 6.4 0.25 | 4750 1067510 | 850 190500 | 3220 722910 | 157.4 347.0 |
| 266DTV1726 | 676.275 26.6250 | 673.100 26.5000 | 914.400 36.0000 | 193.675 7.6250 | 876.30 34.500 | 787.40 31.000 | 787.40 31.000 | 743.00 29.250 | 142.88 5.625 | 6.4 0.25 | 5960 1340100 | 990 222700 | 3930 883820 | 296.6 654.0 |
| 305DTV1727 | 774.700 30.5000 | 768.350 30.2500 | 971.550 38.2500 | 158.750 6.2500 | 885.82 34.875 | 873.10 34.380 | 847.72 33.380 | 827.10 32.560 | 114.30 4.500 | 6.4 0.25 | 5240 1176690 | 820 183480 | 3790 851800 | 194.6 429.0 |
| 312DTV1728 | 793.750 31.2500 | 787.400 31.0000 | 1006.475 39.6250 | 200.025 7.8750 | 1000.12 39.375 | 895.40 35.250 | 901.70 35.500 | 863.60 34.000 | 139.70 5.500 | 6.4 0.25 | 6880 1545670 | 1050 235560 | 5470 1229100 | 325.2 717.0 |
| N-3214-A | 822.400 32.3780 | 808.150 31.8170 | 1066.670 41.9950 | 192.710 7.5870 | 944.58 37.188 | 927.10 36.500 | 908.05 35.750 | 885.82 34.875 | 152.40 6.000 | 7.5 0.30 | 9370 2106090 | 1300 292780 | 2980 668740 | 462.0 1020.0 |
| 405DTV1729 | 1028.700 40.5000 | 1025.525 40.3750 | 1231.900 48.5000 | 158.750 6.2500 | 1143.00 45.000 | 1130.30 44.500 | 1104.90 43.500 | 1084.30 42.690 | 114.30 4.500 | 6.4 0.25 | 7070 1589580 | 920 206180 | 4520 1014510 | 254.4 561.0 |
| 412DTV1730 | 1047.750 41.2500 | 1041.400 41.0000 | 1260.475 49.6250 | 200.025 7.8750 | 1254.12 49.375 | 1149.40 45.250 | 1155.70 45.500 | 1117.60 44.000 | 139.70 5.500 | 6.4 0.25 | 9380 2108710 | 1440 322900 | 6340 1424580 | 417.2 920.0 |
| N-3492-A | 1049.465 41.3175 | 1050.210 41.3470 | 1269.873 49.9950 | 202.296 7.9644 | 1173.17 46.188 | 1147.60 45.180 | 1155.70 45.500 | 1128.50 44.430 | 154.00 6.063 | 6.4 0.25 | 9990 2245560 | 1220 275050 | 3870 870440 | 475.0 1048.0 |
| 541DTV1731 | 1374.775 54.1250 | 1371.600 54.0000 | 1597.025 62.8750 | 247.650 9.7500 | 1536.70 60.500 | 1481.10 58.310 | 1489.08 58.625 | 1447.80 57.000 | 168.28 6.625 | 6.4 0.25 | 13610 3060560 | 1390 311470 | 8730 1962070 | 654.4 1443.0 |
| N-3217-A | 1397.330 55.0130 | 1400.560 55.1400 | 1650.870 64.9950 | 233.375 9.1880 | 1552.58 61.125 | 1524.00 60.000 | 1524.00 60.000 | 1485.90 58.500 | 182.56 7.188 | 6.4 0.25 | 14960 3363110 | 1510 340220 | 4570 1026540 | 631.0 1392.0 |
| C-8598-A | 1654.180 65.1250 | 1651.000 65.0000 | 1905.000 75.0000 | 254.000 10.0000 | 1854.20 73.000 | 1816.10 71.500 | 1790.70 70.500 | 1765.30 69.500 | 184.15 7.250 | 6.4 0.25 | 16820 3781880 | 1570 353790 | 7550 1698000 | 917.0 2023.0 |
| N-3488-A | 1689.430 66.5130 | 1692.660 66.6400 | 1943.100 76.5000 | 254.000 10.0000 | 1879.60 74.000 | 1803.40 71.000 | 1828.80 72.000 | 1778.00 70.000 | 209.55 8.250 | 7.5 0.30 | 16850 3786940 | 1550 349420 | 7560 1700530 | 1270.0 2800.0 |

⁽¹⁾Maximum shaft or housing fillet radius that bearing corners will clear.

THRUST CYLINDRICAL ROLLER BEARINGS

TYPE TP

- Two or three cylindrical rollers per cage pocket to enhance true rolling motion and prevent roller skewing.
- Simple and economical design with easy installation.
- Minor radial displacement of the races does not affect operation, resulting in manufacturing economy and simplified installation.

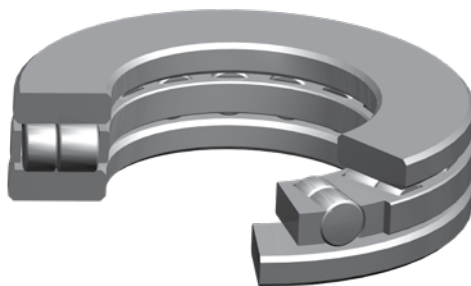
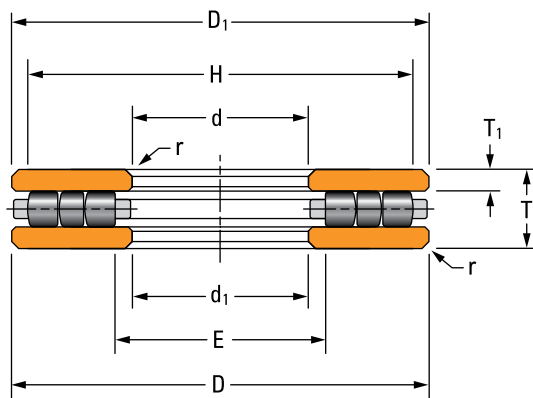

Fig. 62. Type TP thrust cylindrical roller bearing.



OVERALL DIMENSIONS:

- d – Bore diameter
- D – Bearing O.D.
- T – Bearing width
- T₁ – Ring thickness
- d₁ – Large bore I.D.
- D₁ – Small diameter O.D.
- E – Housing shoulder diameter
- H – Shaft shoulder diameter
- r – Shaft/housing maximum fillet radius

Fig. 63. Type TP thrust cylindrical roller bearing assembly.

THRUST BEARING DATA

THRUST CYLINDRICAL ROLLER BEARING – TYPE TP

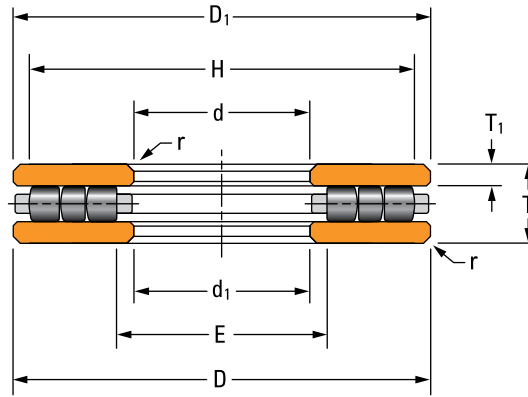
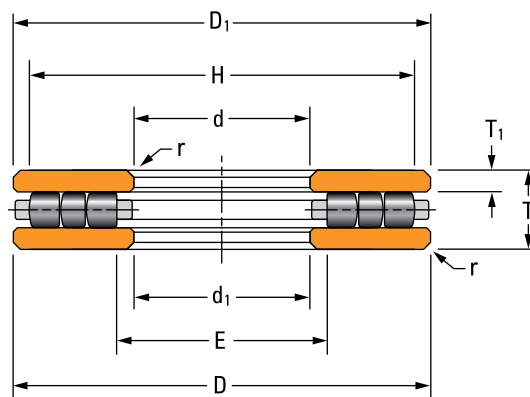

TABLE 41. THRUST CYLINDRICAL ROLLER BEARING – TYPE TP

| Bearing Number | Bearing Dimensions | | | Rings | | | Shoulder Diameter | | Fillet ⁽¹⁾ Radius (Max.) r | Load Rating | | Limiting Speed RPM | Bearing Weight kg lbs. |
|----------------|--------------------|--------------------|------------------|----------------|---------------------|-----------------|-------------------|----------------|--|--------------------|---------------------|-----------------------|---------------------------|
| | Bore | O.D. | Width | Thickness | Small Diameter O.D. | Large Bore I.D. | Shaft (Min.) | Housing (Max.) | | Static Load Rating | Dynamic Load Rating | | |
| | d | D | T | T ₁ | D ₁ | d ₁ | H | E | | C _{a0} | C _a | | |
| | mm in. | mm in. | mm in. | mm in. | mm in. | mm in. | mm in. | mm in. | mm in. | kN lbf. | kN lbf. | | kg lbs. |
| 20TP103 | 50.800 2.0000 | 152.400 6.0000 | 34.925 1.3750 | 9.52 0.375 | 150.81 5.938 | 52.39 2.062 | 141.3 5.56 | 61.9 2.44 | 1.6 0.06 | 1400 315400 | 400 84300 | 1900 | 3.7 8.1 |
| 20TP104 | 50.800 2.0000 | 177.800 7.0000 | 34.925 1.3750 | 9.52 0.375 | 176.21 6.938 | 52.39 2.062 | 163.5 6.44 | 65.1 2.56 | 1.6 0.06 | 1700 384200 | 400 95700 | 1630 | 5.1 11.3 |
| 30TP106 | 76.200 3.0000 | 152.400 6.0000 | 34.925 1.3750 | 9.52 0.375 | 150.81 5.938 | 77.79 3.062 | 142.9 5.62 | 85.7 3.38 | 1.6 0.06 | 1200 279500 | 300 74200 | 1900 | 3.2 7.0 |
| 30TP107 | 76.200 3.0000 | 177.800 7.0000 | 34.925 1.3750 | 9.52 0.375 | 176.21 6.938 | 77.79 3.062 | 166.7 6.56 | 87.3 3.44 | 1.6 0.06 | 1800 401500 | 400 96100 | 1630 | 4.6 10.2 |
| 30TP108 | 76.200 3.0000 | 203.200 8.0000 | 34.925 1.3750 | 9.52 0.375 | 201.61 7.938 | 77.79 3.062 | 188.9 7.44 | 90.5 3.56 | 1.6 0.06 | 2300 523800 | 500 115500 | 1420 | 6.3 13.9 |
| 30TP109 | 76.200 3.0000 | 228.600 9.0000 | 34.925 1.3750 | 9.52 0.375 | 227.01 8.938 | 77.79 3.062 | 212.7 8.38 | 92.1 3.62 | 1.6 0.06 | 3100 698300 | 600 141400 | 1260 | 8.2 18.1 |
| 35TP113 | 88.900 3.5000 | 132.558 5.2188 | 25.400 1.0000 | 7.14 0.281 | 130.97 5.156 | 90.49 3.562 | 123.8 4.88 | 97.6 3.84 | 1.6 0.06 | 700 146200 | 200 37000 | 2190 | 1.4 3.0 |
| 40TP114 | 101.600 4.0000 | 177.800 7.0000 | 44.450 1.7500 | 12.70 0.500 | 176.21 6.938 | 103.19 4.062 | 168.3 6.62 | 111.1 4.38 | 1.6 0.06 | 1700 372500 | 400 97200 | 1630 | 5.0 11.0 |
| 40TP115 | 101.600 4.0000 | 203.200 8.0000 | 44.450 1.7500 | 12.70 0.500 | 201.61 7.938 | 103.19 4.062 | 190.5 7.50 | 114.3 4.50 | 1.6 0.06 | 2300 515700 | 500 122800 | 1420 | 7.1 15.6 |
| 40TP116 | 101.600 4.0000 | 228.600 9.0000 | 44.450 1.7500 | 12.70 0.500 | 227.01 8.938 | 103.19 4.062 | 214.3 8.44 | 115.9 4.56 | 1.6 0.06 | 3000 683500 | 700 150200 | 1260 | 9.5 21.0 |
| 40TP117 | 101.600 4.0000 | 254.000 10.0000 | 44.450 1.7500 | 12.70 0.500 | 252.41 9.938 | 103.19 4.062 | 238.1 9.38 | 117.5 4.62 | 1.6 0.06 | 3700 827600 | 800 171400 | 1140 | 11.6 25.6 |
| 50TP119 | 127.000 5.0000 | 203.200 8.0000 | 44.450 1.7500 | 12.70 0.500 | 201.61 7.938 | 128.59 5.062 | 190.5 7.50 | 139.7 5.50 | 1.6 0.06 | 2100 465800 | 500 110700 | 1420 | 5.9 13.1 |
| 50TP120 | 127.000 5.0000 | 228.600 9.0000 | 44.450 1.7500 | 12.70 0.500 | 227.01 8.938 | 128.59 5.062 | 215.9 8.50 | 139.7 5.50 | 1.6 0.06 | 2900 645200 | 600 140400 | 1260 | 8.3 18.4 |
| 50TP121 | 127.000 5.0000 | 254.000 10.0000 | 50.800 2.0000 | 14.29 0.562 | 252.41 9.938 | 128.59 5.062 | 239.7 9.44 | 141.3 5.56 | 3.2 0.12 | 3700 835900 | 800 184000 | 1140 | 12.4 27.4 |
| 50TP122 | 127.000 5.0000 | 279.400 11.0000 | 50.800 2.0000 | 14.29 0.562 | 277.81 10.938 | 128.59 5.062 | 261.9 10.31 | 144.5 5.69 | 3.2 0.12 | 4800 1073500 | 1000 220000 | 1030 | 15.8 34.8 |
| 50TP123 | 127.000 5.0000 | 304.800 12.0000 | 50.800 2.0000 | 14.29 0.562 | 303.21 11.938 | 128.59 5.062 | 288.9 11.38 | 146.0 5.75 | 3.2 0.12 | 5600 1248900 | 1100 244200 | 950 | 19.4 42.8 |

⁽¹⁾Maximum shaft or housing fillet radius that bearing corners will clear.

Continued on next page.



Continued from previous page.

| Bearing Number | Bearing Dimensions | | | Rings | | | Shoulder Diameter | | Fillet ⁽¹⁾ Radius (Max.) | Load Rating | | Limiting Speed | Bearing Weight |
|-------------------------|--------------------|--------------------|------------------|----------------|---------------------|------------------|-------------------|----------------|-------------------------------------|--------------------|---------------------|----------------|----------------|
| | Bore | O.D. | Width | Thickness | Small Diameter O.D. | Large Bore I.D. | Shaft (Min.) | Housing (Max.) | | Static Load Rating | Dynamic Load Rating | | |
| | d | D | T | T ₁ | D ₁ | d ₁ | H | E | | C ₁₀ | C ₉₀ | | |
| | mm in. | mm in. | mm in. | mm in. | mm in. | mm in. | mm in. | mm in. | mm in. | kN lbf. | kN lbf. | RPM | kg lbs. |
| 60TP124 | 152.400 6.0000 | 228.600 9.0000 | 50.800 2.0000 | 14.29 0.562 | 227.01 8.938 | 153.99 6.062 | 217.2 8.56 | 163.5 6.44 | 3.2 0.12 | 2400 543800 | 600 131100 | 1260 | 7.6 16.8 |
| 60TP125 | 152.400 6.0000 | 254.000 10.0000 | 50.800 2.0000 | 14.29 0.562 | 252.41 9.938 | 153.99 6.062 | 241.3 9.50 | 165.1 6.50 | 3.2 0.12 | 3300 738800 | 700 164000 | 1140 | 10.7 23.7 |
| 60TP126 | 152.400 6.0000 | 279.400 11.0000 | 50.800 2.0000 | 14.29 0.562 | 277.81 10.938 | 153.99 6.062 | 265.1 10.44 | 166.7 6.56 | 3.2 0.12 | 4600 1032600 | 900 209600 | 1030 | 14.2 31.4 |
| 60TP127 | 152.400 6.0000 | 304.800 12.0000 | 50.800 2.0000 | 14.29 0.562 | 303.31 11.938 | 153.99 6.062 | 287.3 11.31 | 169.9 6.69 | 3.2 0.12 | 5600 1252500 | 1100 240600 | 950 | 17.7 39.4 |
| S-4789-A ⁽²⁾ | 174.625 6.8750 | 279.400 11.0000 | 69.850 2.7500 | 19.05 0.750 | 279.40 11.000 | 174.63 6.875 | 262.6 10.34 | 186.4 7.34 | 1.8 0.07 | 3051 686000 | 1156 260000 | 1030 | 17.4 38.3 |
| 70TP129 | 177.800 7.0000 | 254.000 10.0000 | 50.800 2.0000 | 14.29 0.562 | 251.62 9.906 | 180.18 7.094 | 242.9 9.56 | 188.9 7.44 | 3.2 0.12 | 2800 625400 | 600 141600 | 1140 | 9.2 20.2 |
| 70TP130 | 177.800 7.0000 | 279.400 11.0000 | 50.800 2.0000 | 14.29 0.562 | 277.02 10.906 | 180.18 7.094 | 266.7 10.50 | 190.5 7.50 | 3.2 0.12 | 3900 886500 | 800 183200 | 1030 | 12.8 28.3 |
| 70TP131 | 177.800 7.0000 | 304.800 12.0000 | 50.800 2.0000 | 14.29 0.562 | 302.42 11.906 | 180.18 7.094 | 288.9 11.38 | 193.7 7.62 | 3.2 0.12 | 5200 1180100 | 1000 226200 | 950 | 16.8 37.0 |
| 70TP132 | 177.800 7.0000 | 355.600 14.0000 | 76.200 3.0000 | 20.64 0.812 | 353.22 13.906 | 180.18 7.094 | 335.0 13.19 | 198.4 7.81 | 6.4 0.25 | 7500 1692700 | 1700 374300 | 810 | 36.3 80.1 |
| 80TP134 | 203.200 8.0000 | 304.800 12.0000 | 76.200 3.0000 | 20.64 0.812 | 302.42 11.906 | 205.58 8.094 | 292.1 11.50 | 215.9 8.50 | 6.4 0.25 | 4500 1016000 | 1100 254000 | 950 | 20.5 45.1 |
| 80TP135 | 203.200 8.0000 | 355.600 14.0000 | 76.200 3.0000 | 20.64 0.812 | 353.22 13.906 | 205.58 8.094 | 336.6 13.25 | 222.2 8.75 | 6.4 0.25 | 6900 1558900 | 1500 346200 | 810 | 33.0 72.8 |
| 80TP136 | 203.200 8.0000 | 406.400 16.0000 | 76.200 3.0000 | 20.64 0.812 | 404.02 15.906 | 205.58 8.094 | 382.6 15.06 | 227.0 8.94 | 6.4 0.25 | 9300 2091300 | 1900 426700 | 710 | 44.5 98.1 |
| 90TP139 | 228.600 9.0000 | 355.600 14.0000 | 76.200 3.0000 | 20.64 0.812 | 353.22 13.906 | 230.98 9.094 | 339.7 13.38 | 244.5 9.62 | 6.4 0.25 | 6800 1524300 | 1500 335900 | 810 | 29.3 64.5 |
| 90TP140 | 228.600 9.0000 | 406.400 16.0000 | 76.200 3.0000 | 20.64 0.812 | 404.02 15.906 | 230.98 9.094 | 385.8 15.19 | 249.2 9.81 | 6.4 0.25 | 9400 2115800 | 1900 425600 | 710 | 43.6 96.2 |
| C-8360-A | 238.125 9.3750 | 307.975 12.1250 | 38.100 1.5000 | 11.11 0.438 | 306.39 12.063 | 238.51 9.390 | 296.9 11.69 | 249.2 9.81 | 3.18 0.125 | 2380 535500 | 440 99000 | 940 | 6.7 14.8 |
| 100TP143 | 254.000 10.0000 | 406.400 16.0000 | 76.200 3.0000 | 20.64 0.812 | 404.02 15.906 | 256.38 10.094 | 387.4 15.25 | 273.0 10.75 | 6.4 0.25 | 8500 1905400 | 1700 387800 | 710 | 39.5 86.6 |

⁽¹⁾Maximum shaft or housing fillet radius that bearing corners will clear.

⁽²⁾Bearing includes special features; contact your Timken engineer for details.

Continued on next page.

THRUST BEARING DATA

THRUST CYLINDRICAL ROLLER BEARING – TYPE TP

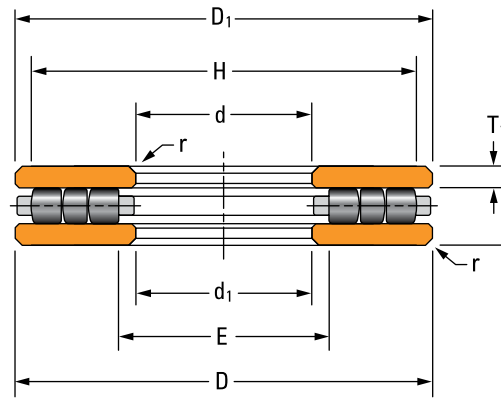

TABLE 41. THRUST CYLINDRICAL ROLLER BEARING – TYPE TP – continued

| Bearing Number | Bearing Dimensions | | | Rings | | | Shoulder Diameter | | Fillet ⁽¹⁾ Radius (Max.) r | Load Rating | | Limiting Speed RPM | Bearing Weight kg lbs. |
|-------------------------|--------------------|--------------------|-------------------|----------------|---------------------|------------------|-------------------|----------------|--|--------------------------------------|---------------------------------------|-----------------------|---------------------------|
| | Bore | O.D. | Width | Thickness | Small Diameter O.D. | Large Bore I.D. | Shaft (Min.) | Housing (Max.) | | Static Load Rating C ₀ | Dynamic Load Rating C _a | | |
| | d | D | T | T ₁ | D ₁ | d ₁ | H | E | | kN lbf. | kN lbf. | | |
| 100TP144 | 254.000 10.0000 | 457.200 18.0000 | 95.250 3.7000 | 26.19 1.031 | 454.82 17.906 | 256.38 10.094 | 435.0 17.12 | 276.2 10.88 | 6.4 0.25 | 12000 2702600 | 2500 559800 | 630 | 68.8 151.8 |
| 100TP145 | 254.000 10.0000 | 508.000 20.0000 | 95.250 3.7500 | 26.19 1.031 | 505.62 19.906 | 256.38 10.094 | 481.0 18.94 | 281.0 11.06 | 6.4 0.25 | 15600 3512400 | 3000 674900 | 570 | 91.7 202.2 |
| F-2658-B | 280.000 11.0236 | 375.400 14.7795 | 53.010 2.0870 | 15.39 0.606 | 374.60 14.748 | 283.01 11.142 | 362.0 14.25 | 292.1 11.50 | 1.5 0.06 | 5410 1217180 | 953 214320 | 770 | 17.4 38.2 |
| 120TP151 | 304.800 12.0000 | 457.200 18.0000 | 95.250 3.7500 | 26.19 1.031 | 454.82 17.906 | 307.18 12.094 | 438.2 17.25 | 323.8 12.75 | 6.4 0.25 | 10800 2423100 | 2200 503600 | 630 | 56.7 125.1 |
| 120TP152 | 304.800 12.0000 | 508.000 20.0000 | 114.300 4.5000 | 31.75 1.250 | 505.62 19.906 | 307.18 12.094 | 484.2 19.06 | 328.6 12.94 | 6.4 0.25 | 12800 2888000 | 2800 626100 | 570 | 104.5 230.5 |
| 120TP153 | 304.800 12.0000 | 609.600 24.0000 | 114.300 4.5000 | 31.75 1.250 | 607.22 23.906 | 307.18 12.094 | 584.2 23.00 | 330.2 13.00 | 6.4 0.25 | 21200 4772700 | 4000 901500 | 470 | 168.5 371.5 |
| S-4790-A ⁽²⁾ | 330.200 13.0000 | 495.300 19.5000 | 88.900 3.5000 | 24.51 0.965 | 495.30 19.500 | 330.20 13.000 | 472.2 18.59 | 352.5 13.88 | 5.6 0.22 | 9329 2098000 | 2575 579000 | 580 | 63.5 139.6 |
| 140TP158 | 355.600 14.0000 | 508.000 20.0000 | 95.250 3.7500 | 26.19 1.031 | 504.82 19.875 | 358.78 14.125 | 489.0 19.25 | 374.6 14.75 | 6.4 0.25 | 12500 2801900 | 2400 546300 | 570 | 62.6 138.1 |
| 140TP159 | 355.600 14.0000 | 558.800 22.0000 | 95.250 3.7500 | 26.19 1.031 | 555.62 21.875 | 358.78 14.125 | 535.0 21.06 | 379.4 14.94 | 6.4 0.25 | 16700 3753400 | 3000 677200 | 520 | 89.6 197.5 |
| 140TP160 | 355.600 14.0000 | 609.600 24.0000 | 95.250 3.7500 | 26.19 1.031 | 606.40 23.875 | 358.78 14.125 | 581.0 22.88 | 384.2 15.12 | 6.4 0.25 | 21600 4846200 | 3600 816500 | 470 | 125.3 276.2 |
| 160TP164 | 406.400 16.0000 | 558.800 22.0000 | 114.300 4.5000 | 31.75 1.250 | 555.60 21.875 | 409.60 16.125 | 539.8 21.25 | 425.4 16.75 | 6.4 0.25 | 13400 3009000 | 2700 616900 | 520 | 85.9 189.4 |
| 160TP165 | 406.400 16.0000 | 609.600 24.0000 | 114.300 4.5000 | 31.75 1.250 | 606.40 23.875 | 409.60 16.125 | 585.8 23.06 | 430.2 16.94 | 6.4 0.25 | 18100 4077300 | 3400 771600 | 470 | 121.4 267.7 |
| 160TP166 | 406.400 16.0000 | 660.400 26.0000 | 114.300 4.5000 | 31.75 1.250 | 657.20 25.875 | 409.60 16.125 | 633.4 24.94 | 433.4 17.06 | 6.4 0.25 | 23100 5191800 | 4100 922000 | 440 | 168.8 372.1 |
| S-4750-A ⁽²⁾ | 431.800 17.0000 | 571.500 22.5000 | 88.900 3.5000 | 24.51 0.965 | 571.50 22.500 | 431.80 17.000 | 553.2 21.78 | 450.1 17.72 | 5.6 0.22 | 11861 2667000 | 2509 564000 | 500 | 70.0 154.0 |
| E-2192-A ⁽²⁾ | 431.800 17.0000 | 609.600 24.0000 | 101.600 4.0000 | 25.40 1.000 | 609.47 23.995 | 432.44 17.025 | 481.0 18.94 | 559.6 22.03 | 7.6 0.30 | 14992 3371000 | 3363 756000 | 470 | 95.0 209.3 |
| E-2191-A | 457.200 18.0000 | 660.400 26.0000 | 101.600 4.0000 | 25.40 1.000 | 660.27 25.995 | 457.33 18.005 | 622.3 24.50 | 495.3 19.00 | 4.0 0.16 | 16241 3651000 | 3580 805000 | 430 | 129.8 285.6 |

⁽¹⁾Maximum shaft or housing fillet radius that bearing corners will clear.

⁽²⁾Bearing includes special features; contact your Timken engineer for details.

Continued on next page.

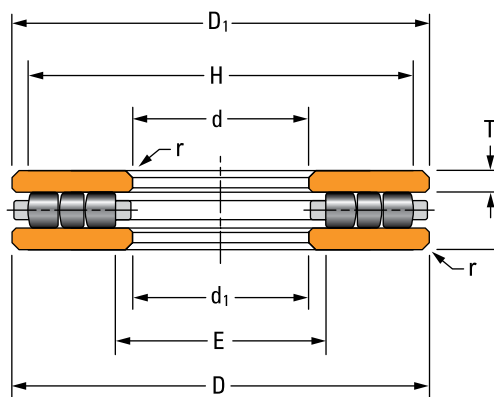

Continued from previous page.

| Bearing Number | Bearing Dimensions | | | Rings | | | Shoulder Diameter | | Fillet ⁽¹⁾ Radius (Max.) | Load Rating | | Limiting Speed | Bearing Weight |
|-------------------------|--------------------|--------------------|-------------------|----------------|---------------------|------------------|-------------------|----------------|-------------------------------------|--------------------|---------------------|----------------|----------------|
| | Bore | O.D. | Width | Thickness | Small Diameter O.D. | Large Bore I.D. | Shaft (Min.) | Housing (Max.) | | Static Load Rating | Dynamic Load Rating | | |
| | d | D | T | T ₁ | D ₁ | d ₁ | H | E | | C _{a0} | C _a | | |
| | mm in. | mm in. | mm in. | mm in. | mm in. | mm in. | mm in. | mm in. | mm in. | kN lbf. | kN lbf. | RPM | kg lbs. |
| 180TP168 | 457.200 18.0000 | 660.400 26.0000 | 127.000 5.0000 | 34.92 1.375 | 657.20 25.875 | 460.40 18.125 | 635.0 25.00 | 482.6 19.00 | 6.4 0.25 | 20400 4580700 | 3900 879900 | 440 | 148.8 328.1 |
| 180TP169 | 457.200 18.0000 | 711.200 28.0000 | 127.000 5.0000 | 34.92 1.375 | 708.00 27.875 | 460.40 18.125 | 684.2 26.94 | 484.2 19.06 | 6.4 0.25 | 25600 5754900 | 4600 1040500 | 410 | 195.3 430.7 |
| 180TP170 | 457.200 18.0000 | 762.000 30.0000 | 139.700 5.5000 | 38.10 1.500 | 758.80 29.875 | 460.40 18.125 | 735.0 28.94 | 484.2 19.06 | 6.4 0.25 | 33100 7434800 | 5900 1332100 | 380 | 280.7 618.9 |
| S-4791-A ⁽²⁾ | 482.600 19.0000 | 673.100 26.5000 | 114.300 4.5000 | 31.75 1.250 | 673.10 19.000 | 482.60 19.000 | 649.7 25.58 | 506.0 19.92 | 5.6 0.22 | 18567 4174000 | 3741 841000 | 430 | 131.8 290.0 |
| 200TP171 | 508.000 20.0000 | 711.200 28.0000 | 139.700 5.5000 | 38.10 1.500 | 708.00 27.875 | 511.20 20.125 | 658.8 27.00 | 533.4 21.00 | 6.4 0.25 | 22400 5045900 | 4400 982700 | 410 | 178.0 392.5 |
| 200TP172 | 508.000 20.0000 | 762.000 30.0000 | 139.700 5.5000 | 38.10 1.500 | 758.80 29.875 | 511.20 20.125 | 736.6 29.00 | 533.4 21.00 | 6.4 0.25 | 28600 6421800 | 5200 1174900 | 380 | 232.2 512.0 |
| 200TP173 | 508.000 20.0000 | 812.800 32.0000 | 152.400 6.0000 | 42.07 1.656 | 809.60 31.875 | 511.20 20.125 | 787.4 31.00 | 533.4 21.00 | 6.4 0.25 | 37500 8422200 | 6600 1494800 | 350 | 317.0 698.9 |
| B-3653-B | 527.101 20.7520 | 635.127 25.0050 | 44.450 1.7500 | 11.13 0.438 | 635.13 25.005 | 527.10 20.752 | 607.2 23.91 | 548.5 21.59 | 3.0 0.12 | 6660 1496180 | 970 218120 | 450 | 29.7 65.4 |
| B-9054-C ⁽²⁾ | 572.000 22.5197 | 763.000 30.0394 | 115.000 4.5276 | 31.50 1.240 | 763.00 30.039 | 572.00 22.520 | 761.2 29.97 | 587.9 23.15 | 4.0 0.16 | 20583 4627000 | 3600 809300 | 380 | 154.5 340.0 |
| 220TP174 | 558.800 22.0000 | 762.000 30.0000 | 139.700 5.5000 | 38.10 1.500 | 758.80 29.875 | 562.00 22.125 | 736.6 29.00 | 584.2 23.00 | 6.4 0.25 | 24400 5484500 | 4600 1027900 | 380 | 192.7 425.0 |
| 220TP175 | 558.800 22.0000 | 812.800 32.0000 | 139.700 5.5000 | 38.10 1.500 | 809.60 31.875 | 562.00 22.125 | 782.6 30.81 | 589.0 23.19 | 6.4 0.25 | 31000 6980200 | 5500 1229800 | 350 | 250.6 552.6 |
| 220TP176 | 558.800 22.0000 | 863.600 34.0000 | 152.400 6.0000 | 42.07 1.656 | 860.40 33.875 | 562.00 22.125 | 838.2 33.00 | 584.2 23.00 | 6.4 0.25 | 40900 9187700 | 7000 1569700 | 330 | 340.9 751.6 |
| J-903-A | 609.702 24.0040 | 812.800 32.0000 | 101.727 4.0050 | 27.79 1.094 | 812.80 32.000 | 609.60 24.000 | 787.4 31.00 | 635.0 25.00 | 1.8 0.07 | 23740 5336110 | 3690 829810 | 350 | 147.0 323.0 |
| 240TP177 | 609.600 24.0000 | 812.800 32.0000 | 139.700 5.5000 | 38.10 1.500 | 809.60 21.875 | 612.80 24.125 | 790.6 31.12 | 631.8 24.88 | 9.5 0.38 | 25500 5733800 | 4660 1047000 | 350 | 206.5 455.4 |
| 240TP178 | 609.600 24.0000 | 863.600 34.0000 | 139.700 5.5000 | 38.10 1.500 | 860.40 33.875 | 612.80 24.125 | 838.2 33.00 | 635.0 25.00 | 9.5 0.38 | 33500 7538700 | 5700 1282100 | 330 | 269.0 593.2 |
| 240TP179 | 609.600 24.0000 | 914.400 36.0000 | 152.400 6.0000 | 42.07 1.656 | 911.20 35.875 | 612.80 24.125 | 889.0 35.00 | 635.0 25.00 | 9.5 0.38 | 41800 9394300 | 7000 1569700 | 310 | 364.7 804.2 |

⁽¹⁾Maximum shaft or housing fillet radius that bearing corners will clear.

⁽²⁾Bearing includes special features; contact your Timken engineer for details.

Continued on next page.

THRUST BEARING DATA

THRUST CYLINDRICAL ROLLER BEARING – TYPE TP

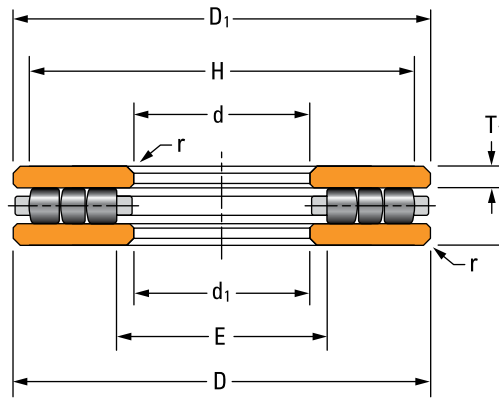

TABLE 41. THRUST CYLINDRICAL ROLLER BEARING – TYPE TP – continued

| Bearing Number | Bearing Dimensions | | | Rings | | | Shoulder Diameter | | Fillet ⁽¹⁾ Radius (Max.) r | Load Rating | | Limiting Speed RPM | Bearing Weight kg lbs. |
|-------------------------|----------------------------|----------------------------|--------------------------|-----------------------|--------------------------|--------------------------|------------------------|------------------------|--|--------------------------|-------------------------|-----------------------|---------------------------|
| | Bore | O.D. | Width | Thickness | Small Diameter O.D. | Large Bore I.D. | Shaft (Min.) | Housing (Max.) | | Static Load Rating | Dynamic Load Rating | | |
| | d | D | T | T ₁ | D ₁ | d ₁ | H | E | | C _{a0} | C _a | | |
| | mm in. | mm in. | mm in. | mm in. | mm in. | mm in. | mm in. | mm in. | mm in. | kN lbf. | kN lbf. | | kg lbs. |
| E-2306-A | 610.019 24.0165 | 812.546 31.9900 | 101.727 4.0050 | 27.79 1.094 | 812.80 32.000 | 610.11 24.020 | 787.4 31.00 | 635.0 25.00 | 1.8 0.07 | 23740 5336110 | 3690 829810 | 350 | 147.0 323.0 |
| S-4792-A ⁽²⁾ | 622.300 24.5000 | 812.800 32.0000 | 114.300 4.5000 | 28.58 1.125 | 812.80 32.000 | 622.30 24.500 | 774.7 30.50 | 679.5 26.75 | 5.6 0.22 | 25853 5812000 | 5111 1149000 | 350 | 360.1 163.3 |
| S-4745-A ⁽²⁾ | 695.579 27.3850 | 964.514 37.9730 | 127.127 5.0050 | 31.75 1.250 | 964.51 37.973 | 695.58 27.385 | 934.2 36.78 | 742.2 29.22 | 7.6 0.30 | 37646 8464000 | 6645 1494000 | 300 | 303.0 667.0 |
| E-2408-A | 711.200 28.0000 | 914.400 36.0000 | 114.300 4.5000 | 29.36 1.156 | 914.40 36.000 | 711.84 28.025 | 888.7 34.99 | 737.6 29.04 | 2.0 0.08 | 26310 5914300 | 4280 963100 | 310 | 180.0 397.0 |
| E-2359-A | 812.800 32.0000 | 1016.000 40.0000 | 127.000 5.0000 | 31.75 1.250 | 1015.75 39.990 | 813.44 32.025 | 990.6 39.00 | 838.2 33.00 | 4.3 0.17 | 30507 6859000 | 6672 1500000 | 280 | 264.0 581.0 |
| E-2259-A | 812.800 32.0000 | 1016.000 40.0000 | 127.000 5.0000 | 32.54 1.281 | 1016.00 40.000 | 813.69 32.035 | 990.6 39.00 | 838.2 33.00 | 1.8 0.07 | 32160 7230700 | 5150 1157600 | 280 | 243.0 535.0 |
| E-2268-A | 876.300 34.5000 | 1117.600 44.0000 | 139.700 5.5000 | 36.55 1.439 | 1117.60 44.000 | 876.30 34.500 | 1091.4 42.97 | 902.8 35.55 | 2.5 0.10 | 35280 7932100 | 5640 1266900 | 260 | 370.0 816.0 |
| E-2311-A | 940.308 37.0200 | 1219.708 48.0200 | 124.587 4.9050 | 40.87 1.609 | 1219.20 48.000 | 939.70 36.996 | 1184.3 46.63 | 974.7 38.38 | 1.8 0.07 | 36120 8120950 | 5710 1283050 | 240 | 468.0 1030.0 |
| P-2109-A | 978.540 38.5250 | 1370.330 53.9500 | 191.000 7.5200 | 57.40 2.260 | 1370.33 53.950 | 978.54 38.525 | 1335.1 52.56 | 1041.4 39.94 | 4.6 0.18 | 90710 20392760 | 12160 2734300 | 210 | 1001.9 2208.8 |
| E-2018-C ⁽²⁾ | 1016.076 40.0030 | 1344.625 52.9380 | 152.400 6.0000 | 41.28 1.625 | 1320.80 52.000 | 40.13 1019.180 | 1308.1 51.50 | 1047.8 41.25 | 1.5 0.06 | 65994 14837000 | 14997 3370000 | 220 | 550.0 1214.0 |

⁽¹⁾Maximum shaft or housing fillet radius that bearing corners will clear.

⁽²⁾Bearing includes special features; contact your Timken engineer for details.

TYPE TPS

- Two or three cylindrical rollers per cage pocket to enhance true rolling motion and prevent roller skewing.
- Similar to type TP except one washer is spherically ground to seat against an aligning ring which makes the bearing assembly adaptable to initial misalignment.
- Not suggested for operating conditions where alignment is constantly changing.

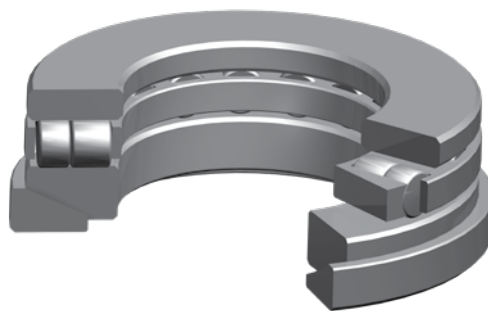
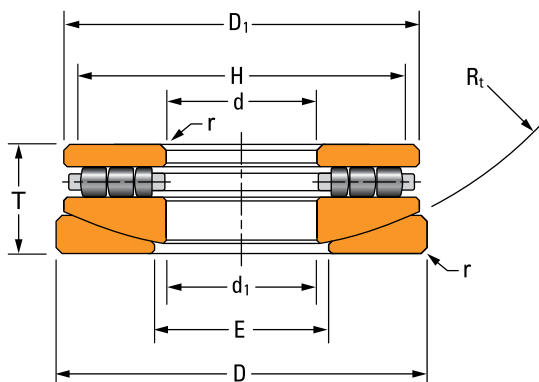

Fig. 64. Type TPS thrust cylindrical roller bearing.



OVERALL DIMENSIONS:

- d – Bore diameter
- D – Bearing O.D.
- T – Bearing width
- R_t – Aligning ring radius
- d_1 – Large bore I.D.
- D_1 – Small diameter O.D.
- E – Housing shoulder diameter
- H – Shaft shoulder diameter
- r – Shaft/housing maximum fillet radius

Fig. 65. Type TPS thrust cylindrical roller bearing assembly.

THRUST BEARING DATA

THRUST CYLINDRICAL ROLLER BEARING – TYPE TPS

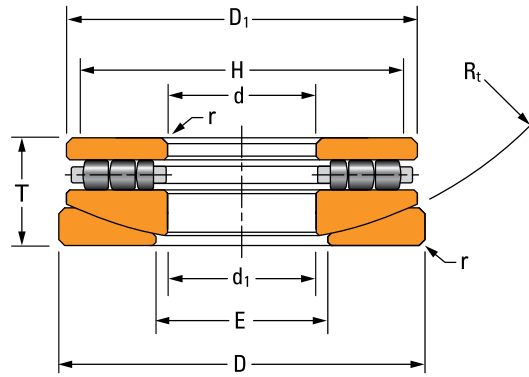
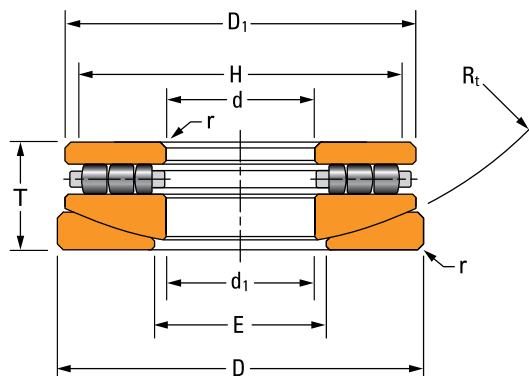

TABLE 42. THRUST CYLINDRICAL ROLLER BEARING – TYPE TPS

| Bearing Number | Bearing Dimensions | | | Rings | | | Shoulder Diameter | | Fillet ⁽¹⁾ Radius (Max.) r | Load Rating | | Limiting Speed RPM | Bearing Weight kg lbs. |
|----------------|--------------------|--------------------|------------------|------------------------|---------------------|-----------------|-------------------|----------------|--|--------------------|---------------------|-----------------------|---------------------------|
| | Bore | O.D. | Width | Aligning Washer Radius | Small Diameter O.D. | Large Bore I.D. | Shaft (Min.) | Housing (Max.) | | Static Load Rating | Dynamic Load Rating | | |
| | d | D | T | R _t | D ₁ | d ₁ | H | E | | C _{a0} | C _a | | |
| | mm in. | mm in. | mm in. | mm in. | mm in. | mm in. | mm in. | mm in. | mm in. | kN lbf. | kN lbf. | | kg lbs. |
| 20TPS103 | 50.800 2.0000 | 160.325 6.3120 | 46.038 1.8125 | 190.50 7.500 | 150.81 5.938 | 52.39 2.062 | 141.3 5.56 | 85.7 3.38 | 1.6 0.06 | 1400 315400 | 400 83600 | 1900 | 5.2 11.4 |
| 20TPS104 | 50.800 2.0000 | 185.725 7.3120 | 46.038 1.8125 | 241.30 9.500 | 176.21 6.938 | 52.39 2.062 | 163.5 6.44 | 108.0 4.25 | 1.6 0.06 | 1700 384200 | 400 95000 | 1630 | 7.1 15.7 |
| 30TPS106 | 76.200 3.0000 | 160.325 6.3120 | 46.038 1.8125 | 152.40 6.000 | 150.81 5.938 | 77.79 3.062 | 142.9 5.62 | 101.6 4.00 | 1.6 0.06 | 1200 279500 | 300 73700 | 1900 | 4.5 9.9 |
| 30TPS107 | 76.200 3.0000 | 185.725 7.3120 | 46.038 1.8125 | 241.30 9.500 | 176.21 6.938 | 77.79 3.062 | 166.7 6.56 | 111.1 4.38 | 1.6 0.06 | 1800 401500 | 400 95500 | 1630 | 6.4 14.2 |
| 30TPS108 | 76.200 3.0000 | 211.125 8.3120 | 46.038 1.8125 | 304.80 12.000 | 201.61 7.938 | 77.79 3.062 | 188.9 7.44 | 133.4 5.25 | 1.6 0.06 | 2300 523800 | 500 114800 | 1420 | 8.7 19.2 |
| 35TPS113 | 88.900 3.5000 | 138.908 5.4688 | 33.338 1.3125 | 127.00 5.000 | 130.97 5.156 | 91.28 3.594 | 123.8 4.88 | 103.2 4.06 | 1.6 0.06 | 700 146400 | 200 36800 | 2190 | 1.9 4.1 |
| 40TPS114 | 101.600 4.0000 | 187.327 7.3750 | 58.738 2.3125 | 161.93 6.375 | 176.21 6.938 | 103.93 4.094 | 168.3 6.62 | 127.0 5.00 | 1.6 0.06 | 1700 372500 | 400 96500 | 1630 | 7.0 15.4 |
| 40TPS115 | 101.600 4.0000 | 212.725 8.3750 | 58.738 2.3125 | 215.90 8.500 | 201.61 7.938 | 103.98 4.094 | 190.5 7.50 | 133.4 5.25 | 1.6 0.06 | 2300 515700 | 500 122000 | 1420 | 10.0 22.1 |
| 40TPS116 | 101.600 4.0000 | 238.125 9.3750 | 58.738 2.3125 | 254.00 10.000 | 227.01 8.938 | 103.98 4.094 | 214.3 8.44 | 149.2 5.88 | 1.6 0.06 | 3000 683500 | 700 149200 | 1260 | 13.4 29.5 |
| 40TPS117 | 101.600 4.0000 | 266.700 10.5000 | 58.738 2.3125 | 355.60 14.000 | 252.41 9.938 | 103.98 4.094 | 238.1 9.38 | 165.1 6.50 | 1.6 0.06 | 3700 827600 | 800 171400 | 1140 | 17.1 37.7 |
| 50TPS119 | 127.000 5.0000 | 215.900 8.5000 | 58.738 2.3125 | 187.33 7.375 | 201.61 7.938 | 130.18 5.125 | 190.5 7.50 | 152.4 6.00 | 1.6 0.06 | 2100 465800 | 500 109800 | 1420 | 8.4 18.5 |
| 50TPS120 | 127.000 5.0000 | 241.300 9.5000 | 58.738 2.3125 | 266.70 10.500 | 227.01 8.938 | 130.18 5.125 | 215.9 8.50 | 155.6 6.12 | 1.6 0.06 | 2900 645200 | 600 139300 | 1260 | 11.8 26.1 |
| 50TPS121 | 127.000 5.0000 | 266.700 10.5000 | 66.675 2.6250 | 323.85 12.750 | 252.41 9.938 | 130.18 5.125 | 239.7 9.44 | 158.8 6.25 | 3.2 0.12 | 3700 835900 | 800 182600 | 1140 | 17.6 38.7 |
| 50TPS122 | 127.000 5.0000 | 292.100 11.5000 | 66.675 2.6250 | 406.40 16.000 | 277.81 10.938 | 130.18 5.125 | 261.9 10.31 | 177.8 7.00 | 3.2 0.12 | 4800 1073500 | 1000 218400 | 1030 | 22.1 48.8 |
| 50TPS123 | 127.000 5.0000 | 317.500 12.5000 | 66.675 2.6250 | 501.65 19.750 | 303.21 11.938 | 130.18 5.125 | 288.9 11.38 | 184.1 7.25 | 3.2 0.12 | 5600 1248900 | 1100 242600 | 950 | 27.2 60.0 |
| 60TPS124 | 152.400 6.0000 | 241.300 9.5000 | 66.675 2.6250 | 171.45 6.750 | 227.01 8.938 | 155.58 6.125 | 217.5 8.56 | 184.1 7.25 | 3.2 0.12 | 2400 543800 | 600 130200 | 1260 | 10.8 23.8 |

⁽¹⁾Maximum shaft or housing fillet radius that bearing corners will clear.

Continued on next page.



Continued from previous page.

| Bearing Number | Bearing Dimensions | | | Rings | | | Shoulder Diameter | | Fillet ⁽¹⁾ Radius (Max.) | Load Rating | | Limiting Speed | Bearing Weight |
|----------------|--------------------|--------------------|-------------------|------------------------|---------------------|------------------|-------------------|----------------|-------------------------------------|--------------------|---------------------|----------------|----------------|
| | Bore | O.D. | Width | Aligning Washer Radius | Small Diameter O.D. | Large Bore I.D. | Shaft (Min.) | Housing (Max.) | | Static Load Rating | Dynamic Load Rating | | |
| | d | D | T | R _t | D ₁ | d ₁ | H | E | C _{a0} | C _a | RPM | kg lbs. | |
| 60TPS125 | 152.400 6.0000 | 266.700 10.5000 | 66.675 2.6250 | 241.30 9.500 | 252.46 9.938 | 155.58 6.125 | 241.3 9.50 | 187.3 7.38 | 3.2 0.12 | 3300 738800 | 700 162900 | 1140 | 15.2 33.5 |
| 60TPS126 | 152.400 6.0000 | 292.100 11.5000 | 66.675 2.6250 | 342.90 13.500 | 277.81 10.938 | 155.58 6.125 | 265.1 10.44 | 187.3 7.38 | 3.2 0.12 | 4600 1032600 | 900 208300 | 1030 | 20.1 44.3 |
| 60TPS127 | 152.400 6.0000 | 317.500 12.5000 | 66.675 2.6250 | 431.80 17.000 | 303.21 11.938 | 155.58 6.125 | 287.3 11.31 | 190.5 7.50 | 3.2 0.12 | 5600 1252500 | 1100 240600 | 950 | 25.2 55.6 |
| 70TPS129 | 177.800 7.0000 | 266.700 10.5000 | 66.675 2.6250 | 206.38 8.125 | 251.62 9.906 | 180.80 7.125 | 242.9 9.56 | 206.4 8.12 | 3.2 0.12 | 2800 625400 | 600 140700 | 1140 | 12.7 27.9 |
| 70TPS130 | 177.800 7.0000 | 292.100 11.5000 | 66.975 2.6250 | 292.10 11.500 | 277.02 10.906 | 180.98 7.125 | 266.7 10.50 | 209.6 8.25 | 3.2 0.12 | 3900 886500 | 800 182100 | 1030 | 17.7 39.1 |
| 70TPS131 | 177.800 7.0000 | 317.500 12.5000 | 66.675 2.6250 | 390.53 15.375 | 302.42 11.906 | 180.98 7.125 | 288.9 11.38 | 209.6 8.25 | 3.2 0.12 | 5200 1180100 | 1000 224800 | 950 | 23.3 51.3 |
| 70TPS132 | 177.800 7.0000 | 374.650 14.7500 | 101.600 4.0000 | 390.53 15.375 | 353.22 13.906 | 180.98 7.125 | 335.0 13.19 | 228.6 9.00 | 6.4 0.25 | 7500 1692700 | 1700 371200 | 810 | 52.6 115.9 |
| 80TPS134 | 203.200 8.0000 | 323.850 12.7500 | 101.600 4.0000 | 215.90 8.500 | 302.42 11.906 | 207.96 8.188 | 292.1 11.50 | 238.1 9.38 | 6.4 0.25 | 4500 1016000 | 1100 251800 | 950 | 29.8 65.8 |
| 80TPS135 | 203.200 8.0000 | 374.650 14.7500 | 101.600 4.0000 | 304.80 12.000 | 353.22 13.906 | 207.96 8.188 | 336.6 13.25 | 263.5 10.38 | 6.4 0.25 | 6900 1558900 | 1500 343800 | 810 | 47.7 105.2 |
| 80TPS136 | 203.200 8.0000 | 428.625 16.8750 | 101.600 4.0000 | 495.30 19.500 | 404.02 15.906 | 209.55 8.250 | 382.6 15.06 | 266.7 10.50 | 6.4 0.25 | 9300 2091300 | 1900 423600 | 710 | 68.2 150.4 |
| 90TPS139 | 228.600 9.0000 | 374.650 14.7500 | 101.600 4.0000 | 304.80 12.000 | 353.22 13.906 | 234.95 9.250 | 339.7 13.38 | 263.5 10.38 | 6.4 0.25 | 6800 1524300 | 1500 333400 | 810 | 42.2 93.1 |
| 90TPS140 | 228.600 9.0000 | 428.625 16.8750 | 101.600 4.0000 | 495.30 19.500 | 404.02 15.906 | 234.95 9.250 | 385.8 15.19 | 266.7 10.50 | 6.4 0.25 | 9400 2115800 | 1900 422200 | 710 | 63.3 139.5 |
| 100TPS143 | 254.000 10.0000 | 428.625 16.8750 | 101.600 4.0000 | 425.45 16.750 | 404.02 15.906 | 260.36 10.250 | 387.4 15.25 | 292.1 11.50 | 6.4 0.25 | 8500 1905400 | 1700 384700 | 710 | 56.2 124.0 |
| 100TPS144 | 254.000 10.0000 | 479.425 18.8750 | 127.000 5.0000 | 508.00 20.000 | 454.82 17.906 | 260.36 10.250 | 435.0 17.12 | 304.8 12.00 | 6.4 0.25 | 12000 2702600 | 2500 556000 | 630 | 99.5 219.5 |
| 100TPS145 | 254.000 10.0000 | 530.225 20.8750 | 127.000 5.0000 | 609.60 24.000 | 505.62 19.906 | 260.36 10.250 | 481.0 18.94 | 336.6 13.25 | 6.4 0.25 | 15600 3512400 | 3000 670600 | 570 | 131.8 290.6 |
| 120TPS151 | 304.800 12.0000 | 479.425 18.8750 | 127.000 5.0000 | 390.53 15.375 | 454.82 17.906 | 311.15 12.250 | 438.2 17.25 | 346.1 13.62 | 6.4 0.25 | 10800 2423800 | 2200 500700 | 630 | 82.1 181.0 |

⁽¹⁾Maximum shaft or housing fillet radius that bearing corners will clear.

Continued on next page.

THRUST BEARING DATA

THRUST CYLINDRICAL ROLLER BEARING – TYPE TPS

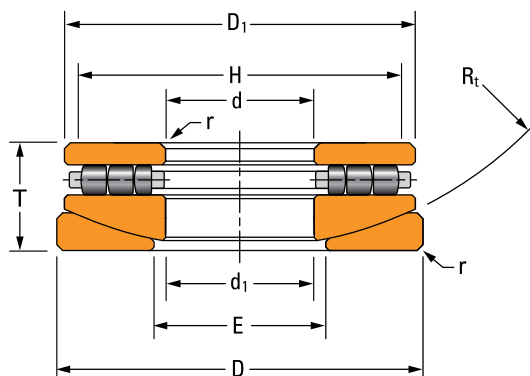

TABLE 42. THRUST CYLINDRICAL ROLLER BEARING – TYPE TPS – continued

| Bearing Number | Bearing Dimensions | | | Rings | | | Shoulder Diameter | | Fillet ⁽¹⁾ Radius (Max.) r | Load Rating | | Limiting Speed RPM | Bearing Weight kg lbs. |
|----------------|--------------------|--------------------|-------------------|------------------------|---------------------|------------------|-------------------|----------------|--|--------------------|---------------------|-----------------------|---------------------------|
| | Bore | O.D. | Width | Aligning Washer Radius | Small Diameter O.D. | Large Bore I.D. | Shaft (Min.) | Housing (Max.) | | Static Load Rating | Dynamic Load Rating | | |
| | d | D | T | R _t | D ₁ | d ₁ | H | E | | C _{a0} | C _a | | |
| | mm in. | mm in. | mm in. | mm in. | mm in. | mm in. | mm in. | mm in. | mm in. | kN lbf. | kN lbf. | | kg lbs. |
| 120TPS152 | 304.800 12.0000 | 530.225 20.8750 | 152.400 6.0000 | 619.13 24.375 | 505.62 19.906 | 311.15 12.250 | 484.2 19.06 | 352.4 13.88 | 6.4 0.25 | 12800 2888000 | 2800 622300 | 570 | 139.4 307.4 |
| 120TPS153 | 304.800 12.0000 | 631.825 24.8750 | 152.400 6.0000 | 723.90 28.500 | 607.22 23.906 | 311.15 12.250 | 584.2 23.00 | 406.4 16.00 | 6.4 0.25 | 21200 4772700 | 4000 896600 | 470 | 236.9 522.4 |
| 140TPS158 | 355.600 14.0000 | 530.225 20.8750 | 123.825 4.8750 | 495.30 19.500 | 504.82 19.875 | 361.95 14.250 | 489.0 19.25 | 393.7 15.50 | 6.4 0.25 | 12500 2801900 | 2400 543200 | 570 | 89.2 196.6 |
| 140TPS159 | 355.600 14.0000 | 581.025 22.8750 | 123.825 4.8750 | 723.90 28.500 | 555.62 21.875 | 361.95 14.250 | 535.0 21.06 | 393.7 15.50 | 6.4 0.25 | 16700 3753400 | 3000 677200 | 520 | 125.0 275.6 |
| 140TPS160 | 355.600 14.0000 | 631.825 24.8750 | 123.825 4.8750 | 917.58 36.125 | 606.62 23.875 | 361.95 14.250 | 581.0 22.88 | 415.9 16.38 | 6.4 0.25 | 21600 4846200 | 3600 816500 | 470 | 170.9 376.9 |
| 160TPS164 | 406.400 16.0000 | 581.025 22.8750 | 152.400 6.0000 | 444.50 17.500 | 555.62 21.875 | 412.75 16.250 | 539.8 21.25 | 444.5 17.50 | 6.4 0.25 | 13400 3009000 | 2700 616900 | 520 | 123.9 273.2 |
| 160TPS165 | 406.400 16.0000 | 635.000 25.0000 | 152.400 6.0000 | 596.90 23.500 | 606.42 23.875 | 412.75 16.250 | 585.8 23.06 | 457.2 18.00 | 6.4 0.25 | 18100 4077300 | 3400 771600 | 470 | 174.4 384.6 |
| 160TPS166 | 406.400 16.0000 | 685.800 27.0000 | 152.400 6.0000 | 752.48 29.625 | 657.20 25.875 | 412.75 16.250 | 633.4 24.94 | 469.9 18.50 | 6.4 0.25 | 23100 5191800 | 4100 922000 | 440 | 229.8 506.7 |

⁽¹⁾Maximum shaft or housing fillet radius that bearing corners will clear.

THRUST SPHERICAL ROLLER BEARINGS TYPES TSR-EJ AND TSR-EM

- Designed to achieve high thrust capacity with low friction and continuous roller alignment.
- Utilize spherically contoured rollers arranged in a steep angular configuration to accommodate high thrust load alone, or in combination with moderate radial loads.
- Low friction of the bearing results from a combination of bearing geometry and manufacturing technology.
- Possess inherent dynamic misalignment capabilities up to 2.5 degrees between shaft and housing.
- Design variants include bearings with steel cage (EJ) or brass cage (EM).



Fig. 66. Type TSR-EJ

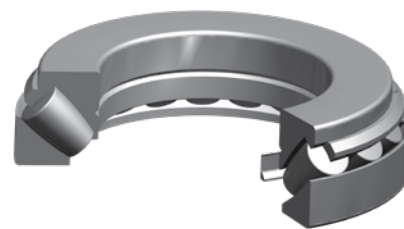

Fig. 67. Type TSR-EM

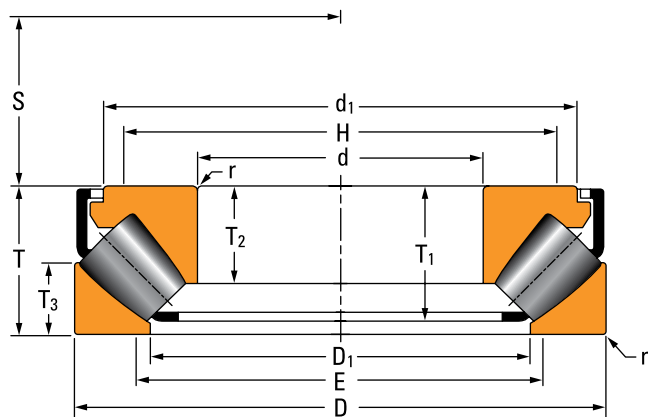

Fig. 68. Type TSR-EJ bearing assembly.

OVERALL DIMENSIONS:

- d – Bore diameter
- D – Bearing O.D.
- d₁ – Inner ring O.D.
- D₁ – Outer ring bore
- T – Bearing width
- T₁ – Inner ring assembly width
- T₂ – Inner ring width
- T₃ – Outer ring width
- E – Housing shoulder diameter
- H – Shaft shoulder diameter
- S – Pivot center location
- r – Shaft/housing maximum fillet radius

DESIGN TYPES

TSR-EJ

- Spherical inner and outer races.
- Utilizes window-type steel cage which unitizes the cage and roller assembly with the inner ring via cage tabs.
- Optimized internal geometry, roller design and surface finishing to minimize torque and heat generation, improve lubrication, and maximize load capacity.

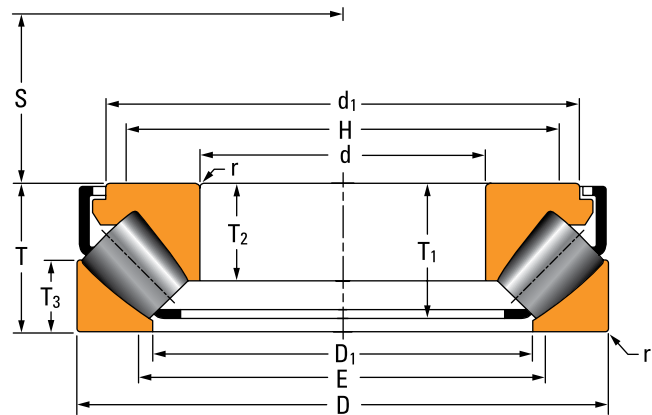

Fig. 69. Type TSR-EJ

TSR-EM

- Spherical inner and outer races.
- Utilizes large end roller-riding brass cage design which enhances lubrication flow and enables maximized roller length to provide high thrust load capacity within the envelope.
- Roller-cage assembly is unitized to the inner ring via a steel cage band for easier bearing mounting and handling.

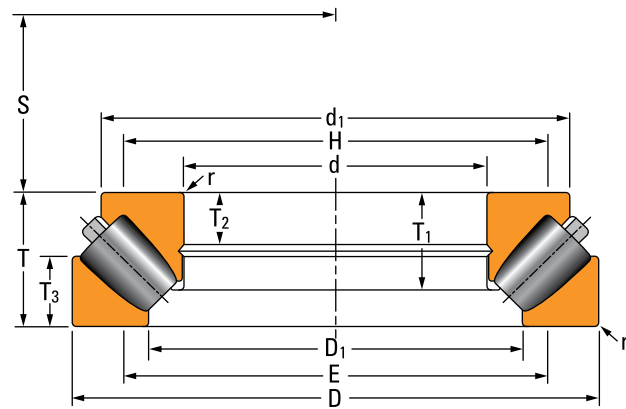
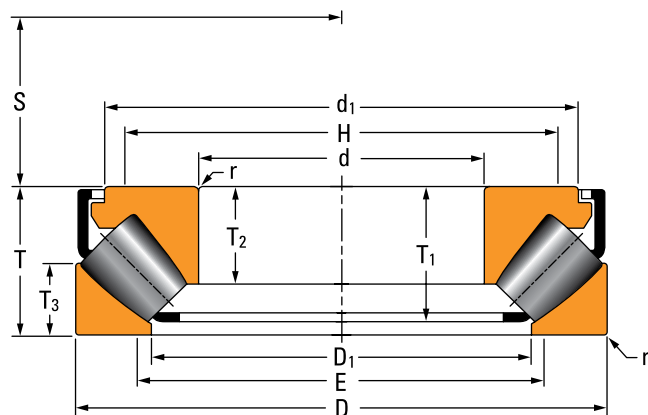

Fig. 70. Type TSR-EM.

TABLE 42A. TIMKEN THRUST SPHERICAL ROLLER BEARING MODIFICATION CODES

| Mod Code | Timken General Definition |
|----------|--|
| W8 | TDC coated rings & rollers |
| W16 | Special internal features |
| W18 | Inner ring with special squareness and parallelism tolerance |
| W23 | Wide inner ring |
| W40 | Rings and rollers made of carburizing-grade steel |
| W40B | Rings made of carburizing-grade steel. |
| W40R | Rollers only made of carburizing-grade steel |
| W50 | Tapped holes in face of inner ring (imperial) |
| W50B | Tapped holes in face of inner ring (metric) |
| W57 | Wide outer ring |
| W66 | Special tolerances on spacer (where spacer requested) |
| W98 | Inner ring with undersize bore |
| W896D | W23-Wider inner ring + W57-Wider outer ring |
| W921 | Large chamfer on outer ring bore |

THRUST SPHERICAL ROLLER BEARINGS – TYPE TSR-EJ AND TYPE TSR-EM



Type TSR-EJ

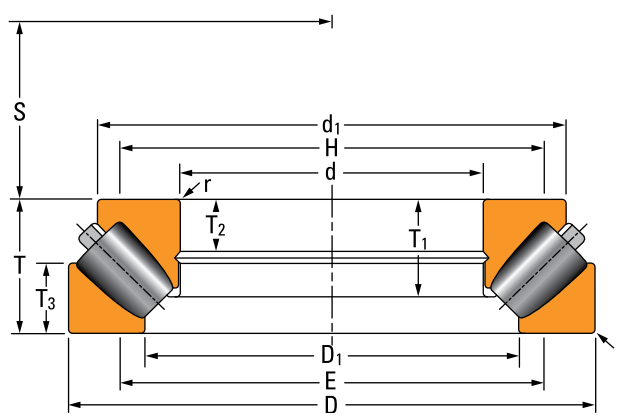

Type TSR-EM

TABLE 43. THRUST SPHERICAL ROLLER BEARINGS

| Bearing Number | Bearing Dimensions | | | | | Shoulder Diameter | | Mounting Dimensions | | | | | Load Rating | | Thermal Speed Rating | Limiting Speed | Bearing Weight | Kc ⁽²⁾ |
|----------------|--------------------|----------------|--------------|-----------------|-----------------|-------------------|--------------|---------------------|----------------|----------------|-------------------------------------|--------------------|---------------------|----------------|----------------------|----------------|----------------|-------------------|
| | Bore | O.D. | Width | Inner Ring O.D. | Outer Ring Bore | Housing (Max.) | Shaft (Min.) | | | | Fillet ⁽¹⁾ Radius (Max.) | Static Load Rating | Dynamic Load Rating | | | | | |
| | d | D | T | d ₁ | D ₁ | E | H | T ₁ | T ₂ | T ₃ | S | r | C _{a0} | C _a | | | | |
| mm in. | mm in. | mm in. | mm in. | mm in. | mm in. | mm in. | mm in. | mm in. | mm in. | mm in. | mm in. | mm in. | kN lbf. | kN lbf. | RPM | RPM | kg lbs. | |
| 29418EJ | 90 3.5433 | 190 7.4803 | 60 2.3622 | 164.6 6.48 | 127.5 5.02 | 137 5.39 | 148 5.83 | 51.9 2.04 | 39 1.54 | 28.5 1.12 | 56 2.2 | 2 0.08 | 1890 426000 | 820 184000 | 2000 | 3410 | 7.4 16.3 | 20 |
| 29320EJ | 100 3.937 | 170 6.6929 | 42 1.6535 | 152.3 6 | 127.5 5.02 | 134 5.28 | 141 5.55 | 35.4 1.39 | 26.2 1.03 | 20.5 0.81 | 58 2.28 | 1.5 0.06 | 1240 278000 | 462 104000 | 2000 | 3540 | 3.5 7.7 | 10 |
| 29420EJ | 100 3.937 | 210 8.2677 | 67 2.6378 | 182.2 7.17 | 141.5 5.57 | 151 5.94 | 164 6.46 | 58 2.28 | 43 1.69 | 32 1.26 | 62 2.44 | 2.5 0.1 | 2390 536000 | 1020 230000 | 1800 | 3080 | 10.1 22.4 | 40 |
| 29322EJ | 110 4.3307 | 190 7.4803 | 48 1.8908 | 171.1 6.74 | 140 5.51 | 149 5.87 | 157 6.18 | 40.3 1.59 | 30.3 1.19 | 24.8 0.98 | 63.8 2.51 | 2 0.08 | 1660 372000 | 604 136000 | 1800 | 3180 | 4.7 10.5 | 15 |
| 29422EJ | 110 4.3307 | 230 9.0551 | 73 2.874 | 199.4 7.85 | 155.5 6.12 | 167 6.57 | 180 7.09 | 63.2 2.49 | 47 1.85 | 34.7 1.37 | 69 2.72 | 2.5 0.1 | 2840 638000 | 1200 269000 | 1700 | 2810 | 13.2 29.1 | 45 |
| 29324EJ | 120 4.7244 | 210 8.2677 | 54 2.126 | 188.1 7.41 | 154 6.06 | 163 6.42 | 172 6.77 | 46 1.81 | 34 1.34 | 27 1.06 | 70 2.76 | 2 0.08 | 2070 466000 | 768 173000 | 1700 | 2890 | 7.2 15.8 | 25 |
| 29424EJ | 120 4.7244 | 250 9.8425 | 78 3.0709 | 216.8 8.54 | 171 6.73 | 182 7.17 | 197 7.76 | 68.5 2.7 | 50.5 1.99 | 36.5 1.44 | 74 2.92 | 3 0.12 | 3320 746000 | 1390 312000 | 1500 | 2580 | 16.6 36.7 | 60 |
| 29326EJ | 130 5.1181 | 225 8.8583 | 58 2.2835 | 203.4 8.01 | 165.5 6.52 | 177 6.97 | 186 7.32 | 48.6 1.91 | 36.7 1.44 | 30.1 1.19 | 75.6 2.98 | 2 0.08 | 2410 543000 | 852 192000 | 1600 | 2690 | 8.8 19.4 | 25 |
| 29426EJ | 130 5.1181 | 270 10.6299 | 85 3.3464 | 234.4 9.23 | 184.5 7.26 | 197 7.76 | 213 8.39 | 72.7 2.86 | 54 2.13 | 40.9 1.61 | 81 3.19 | 3 0.12 | 3870 871000 | 1600 359000 | 1400 | 2390 | 20.9 46 | 80 |
| 29328EJ | 140 5.5118 | 240 9.4488 | 60 2.3622 | 216.1 8.51 | 177 6.97 | 188 7.4 | 199 7.83 | 51.7 2.04 | 38.5 1.52 | 30 1.18 | 82 3.23 | 2 0.08 | 2710 609000 | 970 218000 | 1500 | 2510 | 10.2 22.5 | 40 |
| 29428EJ | 140 5.5118 | 280 11.0236 | 85 3.3464 | 245.4 9.66 | 194.5 7.66 | 207 8.15 | 223 8.78 | 72.9 2.87 | 54 2.13 | 41 1.61 | 86 3.39 | 3 0.12 | 4110 924000 | 1640 369000 | 1300 | 2270 | 22.1 48.6 | 90 |
| 29330EJ | 150 5.9055 | 250 9.8425 | 60 2.3622 | 223.9 8.82 | 190 7.48 | 198 7.8 | 209 8.23 | 52.2 2.06 | 38 1.5 | 28 1.1 | 87 3.43 | 2 0.08 | 2760 620000 | 993 223000 | 1400 | 2390 | 10.6 23.3 | 45 |
| 29430EJ | 150 5.9055 | 300 11.811 | 90 3.5433 | 262.9 10.35 | 207.5 8.17 | 222 8.74 | 238 9.37 | 78.3 3.08 | 58 2.28 | 43.4 1.71 | 92 3.62 | 3 0.12 | 4730 1060000 | 1860 418000 | 1200 | 2120 | 27 59.5 | 115 |
| 29332EJ | 160 6.2992 | 270 10.6299 | 67 2.6378 | 243.5 9.59 | 203 7.99 | 213 8.39 | 225 8.86 | 57.4 2.26 | 42 1.65 | 33 1.3 | 92 3.62 | 2.5 0.1 | 3370 758000 | 1190 267000 | 1300 | 2220 | 14.2 31.2 | 60 |
| 29432EJ | 160 6.2992 | 320 12.5984 | 95 3.7402 | 279.3 11 | 223.5 8.8 | 237 9.33 | 255 10.04 | 82.2 3.24 | 60.5 2.38 | 45.5 1.79 | 99 3.9 | 4 0.16 | 5340 1200000 | 2100 472000 | 1200 | 1990 | 32 70.6 | 150 |
| 29334EJ | 170 6.6929 | 280 11.0236 | 67 2.6378 | 251.2 9.89 | 215 8.46 | 223 8.78 | 235 9.25 | 58.6 2.31 | 42.2 1.66 | 30.5 1.2 | 96 3.78 | 2.5 0.1 | 3430 770000 | 1230 277000 | 1200 | 2120 | 14.5 32.1 | 70 |

⁽¹⁾Maximum shaft or housing fillet radius that bearing corners will clear.

⁽²⁾Centrifugal force constant for induced thrust load calculation found on page 21.

Continued on next page.

THRUST BEARING DATA

THRUST SPHERICAL ROLLER BEARINGS – TYPE TSR-EJ AND TYPE TSR-EM

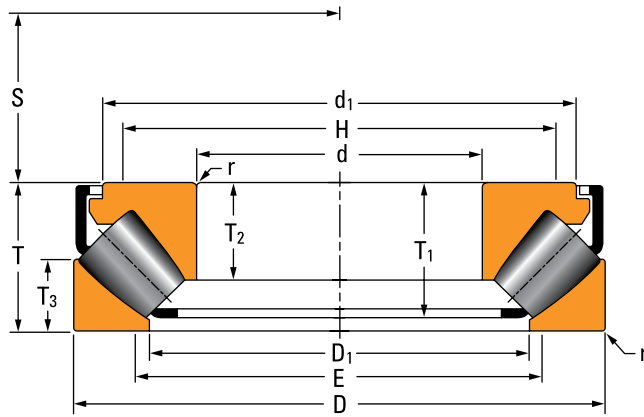

Type TSR-EJ

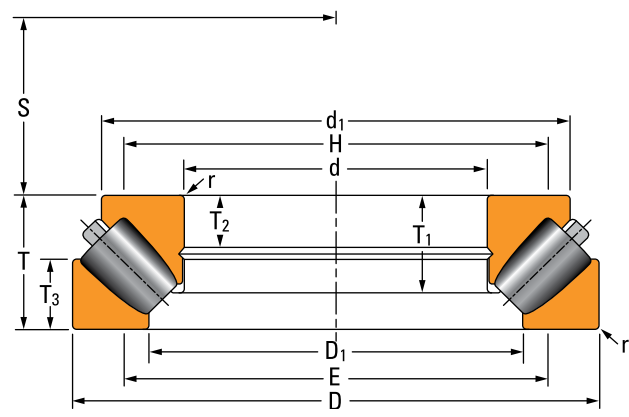

Type TSR-EM

TABLE 43. THRUST SPHERICAL ROLLER BEARINGS – continued

| Bearing Number | Bearing Dimensions | | | | | Shoulder Diameter | | Mounting Dimensions | | | | | Load Rating | | Thermal Speed Rating | Limiting Speed | Bearing Weight | Kc ⁽²⁾ | |
|----------------|--------------------|----------------|---------------|-----------------|-----------------|-------------------|--------------|-------------------------------------|--------------------|---------------------|-----------------|----------------|------------------|-----------------|----------------------|----------------|----------------|-------------------|---------|
| | Bore | O.D. | Width | Inner Ring O.D. | Outer Ring Bore | Housing (Max.) | Shaft (Min.) | Fillet ⁽¹⁾ Radius (Max.) | Static Load Rating | Dynamic Load Rating | C _{a0} | C _a | RPM | RPM | | | | | kg lbs. |
| | d | D | T | d ₁ | D ₁ | E | H | | | | | | | | | | | | |
| 29434EJ | 170 6.6929 | 340 13.3858 | 103 4.0551 | 297.7 11.72 | 236 9.29 | 251 9.88 | 270 10.63 | 89 3.5 | 65.5 2.58 | 50 1.97 | 104 4.09 | 4 0.16 | 6140 1380000 | 2380 536000 | 1100 | 1870 | 39.7 87.4 | 195 | |
| 29336EJ | 180 7.0866 | 300 11.811 | 73 2.875 | 270 10.63 | 227 8.94 | 238 9.37 | 251 9.88 | 62.7 2.47 | 46 1.81 | 35.5 1.4 | 103 4.06 | 2.5 0.1 | 4130 927000 | 1430 322000 | 1200 | 1990 | 18.6 41.1 | 90 | |
| 29436EJ | 180 7.0866 | 360 14.1732 | 109 4.2913 | 315.9 12.44 | 250 9.84 | 267 10.51 | 286 11.26 | 94.1 3.7 | 69.5 2.74 | 53 2.09 | 110 4.33 | 4 0.16 | 7090 1590000 | 2660 598000 | 990 | 1770 | 47.5 104.7 | 245 | |
| 29338EJ | 190 7.4803 | 320 12.5984 | 78 3.076 | 285.6 11.25 | 243.5 9.59 | 253 9.96 | 268 10.55 | 67.7 2.66 | 49 1.93 | 36 1.42 | 110 4.33 | 3 0.12 | 4550 1020000 | 1620 364000 | 1100 | 1870 | 22.5 49.6 | 120 | |
| 29438EJ | 190 7.4803 | 380 14.9606 | 115 4.5276 | 332.9 13.11 | 264.5 10.41 | 281 11.06 | 303 11.93 | 100.3 3.95 | 73 2.87 | 55.5 2.19 | 117 4.61 | 4 0.16 | 7910 1780000 | 3040 683000 | 930 | 1680 | 55.7 122.9 | 320 | |
| 29340EJ | 200 7.874 | 340 13.3858 | 85 3.348 | 304.3 11.98 | 257 10.12 | 269 10.59 | 284 11.18 | 73.9 2.91 | 53.5 2.11 | 40 1.57 | 116 4.57 | 3 0.12 | 5370 1210000 | 1880 423000 | 1000 | 1770 | 28.4 62.7 | 155 | |
| 29440EJ | 200 7.874 | 400 15.748 | 122 4.8031 | 350.7 13.81 | 277.5 10.93 | 295 11.61 | 317 12.48 | 104.2 4.1 | 77 3.03 | 59.4 2.34 | 122 4.8 | 4 0.16 | 8470 1900000 | 3210 723000 | 900 | 1590 | 64.8 142.8 | 370 | |
| 29344EJ | 220 8.6614 | 360 14.1716 | 85 3.3477 | 326.3 12.85 | 273.5 10.77 | 288 11.34 | 303 11.93 | 74.1 2.92 | 55 2.17 | 41 1.61 | 125 4.92 | 3 0.12 | 5840 1310000 | 1950 437000 | 960 | 1650 | 30.7 67.6 | 175 | |
| 29444EJ | 220 8.6614 | 420 16.5354 | 122 4.8031 | 371.6 14.63 | 300 11.81 | 317 12.48 | 339 13.35 | 105.7 4.16 | 77 3.03 | 58.5 2.3 | 132 5.2 | 5 0.2 | 9090 2040000 | 3350 754000 | 830 | 1490 | 69.4 153.1 | 435 | |
| 29348EJ | 240 9.4488 | 380 14.9606 | 85 3.3477 | 345.1 13.59 | 295.5 11.63 | 308 12.13 | 323 12.72 | 74.4 2.93 | 54 2.13 | 40.5 1.59 | 135 5.32 | 3 0.12 | 6280 1410000 | 2040 458000 | 870 | 1540 | 32.8 72.4 | 210 | |
| 29448EJ | 240 9.4488 | 440 17.3228 | 122 4.8031 | 391.6 15.42 | 322 12.68 | 338 13.31 | 360 14.17 | 104.7 4.12 | 76 2.99 | 59 2.32 | 142 5.59 | 5 0.2 | 9520 2140000 | 3410 767000 | 770 | 1400 | 73.3 161.6 | 490 | |
| 29352EJ | 260 10.2362 | 420 16.5354 | 95 3.7402 | 382.2 15.05 | 324 12.76 | 340 13.39 | 356 14.02 | 84.7 3.33 | 61 2.4 | 46 1.81 | 148 5.83 | 4 0.16 | 8100 1820000 | 2580 579000 | 790 | 1400 | 46.9 103.4 | 330 | |
| 29452EJ | 260 10.2362 | 480 18.8976 | 132 5.1969 | 427.9 16.85 | 346 13.62 | 367 14.45 | 391 15.39 | 116.9 4.6 | 86 3.39 | 63 2.48 | 154 6.06 | 5 0.2 | 11900 2680000 | 4160 935000 | 690 | 1290 | 96.4 212.4 | 715 | |
| 29356EJ | 280 11.0236 | 440 17.3228 | 95 3.7418 | 401 15.79 | 343 13.5 | 360 14.17 | 376 14.8 | 84.7 3.33 | 62 2.44 | 45.5 1.79 | 158 6.22 | 4 0.16 | 8500 1910000 | 2580 580000 | 740 | 1330 | 49.5 109 | 355 | |
| 29456EJ | 280 11.0236 | 520 20.4724 | 145 5.7148 | 464.3 18.28 | 372 14.65 | 397 15.63 | 423 16.65 | 128.9 5.07 | 95 3.74 | 70 2.76 | 166 6.54 | 5 0.2 | 14300 3220000 | 4920 1110000 | 630 | 1190 | 126.3 278.3 | 1000 | |
| 29360EJ | 300 11.811 | 480 18.8978 | 109 4.2929 | 434.1 17.09 | 372 14.65 | 388 15.28 | 407 16.02 | 95.5 3.76 | 70 2.76 | 51 2.01 | 168 6.61 | 4 0.16 | 9900 2230000 | 3150 709000 | 690 | 1220 | 67.3 148.4 | 530 | |

⁽¹⁾Maximum shaft or housing fillet radius that bearing corners will clear.

⁽²⁾Centrifugal force constant for induced thrust load calculation found on page 21.

Continued on next page.

THRUST SPHERICAL ROLLER BEARINGS – TYPE TSR-EJ AND TYPE TSR-EM

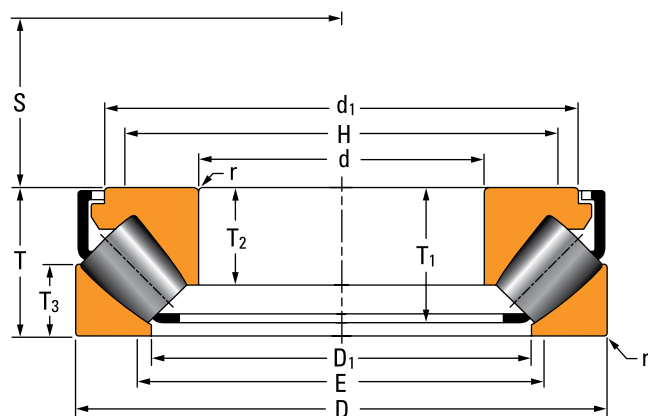

Type TSR-EJ

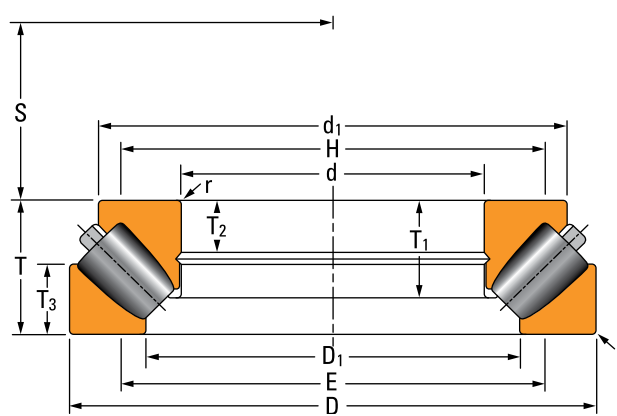

Type TSR-EM

Continued from previous page.

| Bearing Number | Bearing Dimensions | | | | | Shoulder Diameter | | Mounting Dimensions | | | | | Load Rating | | Thermal Speed Rating | Limiting Speed | Bearing Weight | Kc ⁽²⁾ |
|----------------|--------------------|---------|--------|-----------------|-----------------|-------------------|--------------|-------------------------------------|--------------------|---------------------|-----------------|----------------|----------------|----------------|----------------------|----------------|----------------|-------------------|
| | Bore | O.D. | Width | Inner Ring O.D. | Outer Ring Bore | Housing (Max.) | Shaft (Min.) | Fillet ⁽¹⁾ Radius (Max.) | Static Load Rating | Dynamic Load Rating | C _{a0} | C _a | | | | | | |
| | d | D | T | d ₁ | D ₁ | E | H | | | | | | T ₁ | T ₂ | | | | |
| in. | in. | in. | in. | in. | in. | in. | in. | in. | in. | in. | in. | in. | in. | in. | in. | in. | in. | in. |
| 29460EJ | 300 | 540 | 145 | 485 | 392 | 418 | 443 | 128.6 | 95 | 70.5 | 175 | 5 | 15000 | 4990 | 600 | 1140 | 132.6 | 1090 |
| | 11.811 | 21.2598 | 5.7087 | 19.09 | 15.43 | 16.46 | 17.44 | 5.06 | 3.74 | 2.78 | 6.89 | 0.2 | 3370000 | 1120000 | | | 292.2 | |
| 29364EJ | 320 | 500 | 109 | 460 | 391 | 407 | 427 | 94.4 | 68 | 53 | 180 | 4 | 10700 | 2830 | 650 | 1170 | 71.6 | 615 |
| | 12.5984 | 19.685 | 4.2913 | 18.11 | 15.39 | 16.02 | 16.81 | 3.72 | 2.68 | 2.09 | 7.09 | 0.16 | 2400000 | 636000 | | | 157.8 | |
| 29464EM | 320 | 580 | 155 | 514 | 407 | 444 | 469 | 112.2 | 56.3 | 80.5 | 191 | 6 | 18909 | 5155 | 530 | 1060 | 164 | 1485 |
| | 12.5984 | 22.8346 | 6.1024 | 20.24 | 16.02 | 17.48 | 18.46 | 4.42 | 2.22 | 3.17 | 7.52 | 0.24 | 4251000 | 1159000 | | | 361.5 | |
| 29368EJ | 340 | 540 | 122 | 497 | 428 | 443 | 463 | 102.6 | 73.5 | 59.5 | 192 | 4 | 12000 | 3120 | 620 | 1090 | 94.8 | 765 |
| | 13.3858 | 21.2598 | 4.8031 | 19.57 | 16.85 | 17.44 | 18.23 | 4.04 | 2.89 | 2.34 | 7.56 | 0.16 | 2690000 | 702000 | | | 209 | |
| 29468EM | 340 | 620 | 170 | 550 | 431 | 473 | 500 | 123.7 | 72 | 88 | 202 | 6 | 22030 | 5920 | 490 | 1000 | 207 | 1960 |
| | 13.3858 | 24.4094 | 6.6929 | 21.65 | 16.97 | 18.62 | 19.69 | 4.87 | 2.84 | 3.46 | 7.95 | 0.24 | 4953000 | 1331000 | | | 456.3 | |
| 29372EM | 360 | 560 | 122 | 511 | 428 | 457 | 476 | 86.9 | 50 | 65 | 202 | 4 | 15130 | 3630 | 540 | 1040 | 102.1 | 960 |
| | 14.1732 | 22.0472 | 4.8031 | 20.12 | 16.85 | 17.99 | 18.74 | 3.42 | 1.97 | 2.56 | 7.95 | 0.16 | 3402000 | 816400 | | | 225 | |
| 29472EM | 360 | 640 | 170 | 585 | 474 | 498 | 528 | 119.6 | 63 | 83.5 | 210 | 6 | 19500 | 5440 | 510 | 1000 | 209.2 | 2035 |
| | 14.1732 | 25.1968 | 6.6929 | 23.03 | 18.66 | 19.61 | 20.79 | 4.71 | 2.48 | 3.29 | 8.27 | 0.24 | 4380000 | 1220000 | | | 461.3 | |
| 29376EM | 380 | 600 | 132 | 546 | 455 | 486 | 507 | 94.5 | 49 | 70 | 216 | 5 | 17780 | 4300 | 500 | 970 | 129.7 | 1315 |
| | 14.9606 | 23.622 | 5.1969 | 21.5 | 17.91 | 19.13 | 19.96 | 3.72 | 1.93 | 2.76 | 8.5 | 0.2 | 3996000 | 965500 | | | 285.9 | |
| 29476EM | 380 | 670 | 175 | 597 | 477 | 518 | 546.1 | 126.5 | 73.1 | 91 | 224 | 6 | 24870 | 6490 | 440 | 900 | 241.7 | 2550 |
| | 14.9606 | 26.378 | 6.8898 | 23.5 | 18.78 | 20.39 | 21.5 | 4.98 | 2.87 | 3.58 | 8.82 | 0.24 | 5592000 | 1460000 | | | 564.4 | |
| 29380EM | 400 | 620 | 132 | 575 | 494 | 510 | 534 | 90.5 | 48 | 64 | 225 | 5 | 15100 | 3850 | 530 | 940 | 128.6 | 1315 |
| | 15.748 | 24.4094 | 5.1968 | 22.64 | 19.45 | 20.08 | 21.02 | 3.56 | 1.89 | 2.52 | 8.86 | 0.2 | 3390000 | 864000 | | | 283.5 | |
| 29480EM | 400 | 710 | 185 | 632 | 501 | 547 | 577.1 | 134.9 | 77.7 | 97 | 237 | 6 | 28470 | 7330 | 410 | 860 | 290.4 | 3245 |
| | 15.748 | 27.9528 | 7.2835 | 24.88 | 19.72 | 21.54 | 22.72 | 5.31 | 3.06 | 3.82 | 9.33 | 0.24 | 6400000 | 1649000 | | | 640.2 | |
| 29284EM | 420 | 580 | 95 | 540 | 479 | 498 | 513.1 | 65.2 | 38 | 52 | 225 | 4 | 12460 | 2680 | 580 | 960 | 68.2 | 735 |
| | 16.5354 | 22.8346 | 3.7402 | 21.26 | 18.86 | 19.61 | 20.2 | 2.57 | 1.42 | 2.05 | 8.86 | 0.16 | 2802000 | 602900 | | | 150.3 | |
| 29384EM | 420 | 650 | 140 | 600 | 520 | 537 | 561 | 95.8 | 53 | 67.5 | 235 | 5 | 16000 | 4040 | 510 | 890 | 148.3 | 1515 |
| | 16.5354 | 25.5906 | 5.5118 | 23.62 | 20.47 | 21.14 | 22.09 | 3.77 | 2.09 | 2.66 | 9.25 | 0.2 | 3610000 | 909000 | | | 326.9 | |
| 29484EM | 420 | 730 | 185 | 670 | 545 | 576 | 608 | 133.4 | 70 | 90.5 | 244 | 6 | 26000 | 6780 | 430 | 830 | 295.4 | 3345 |
| | 16.5354 | 28.7402 | 7.2835 | 26.38 | 21.46 | 22.68 | 23.94 | 5.25 | 2.76 | 3.56 | 9.61 | 0.24 | 5860000 | 1530000 | | | 651.3 | |
| 29388EM | 440 | 680 | 145 | 631.5 | 540 | 561 | 585 | 101.1 | 52 | 70.5 | 245 | 5 | 18500 | 4530 | 480 | 850 | 175.2 | 1860 |
| | 17.3228 | 26.7717 | 5.7087 | 24.86 | 21.26 | 22.09 | 23.03 | 3.98 | 2.05 | 2.78 | 9.65 | 0.2 | 4160000 | 1020000 | | | 377.3 | |
| 29488EM | 440 | 780 | 206 | 694 | 554 | 602 | 635 | 148.3 | 89 | 108 | 257 | 8 | 33710 | 8610 | 370 | 780 | 387.4 | 4680 |
| | 17.3228 | 30.7087 | 8.1102 | 27.32 | 21.81 | 23.7 | 25 | 5.84 | 3.5 | 4.25 | 10.12 | 0.31 | 7579000 | 1935000 | | | 854.1 | |

⁽¹⁾Maximum shaft or housing fillet radius that bearing corners will clear.

⁽²⁾Centrifugal force constant for induced thrust load calculation found on page 21.

Continued on next page.

THRUST BEARING DATA

THRUST SPHERICAL ROLLER BEARINGS – TYPE TSR-EJ AND TYPE TSR-EM

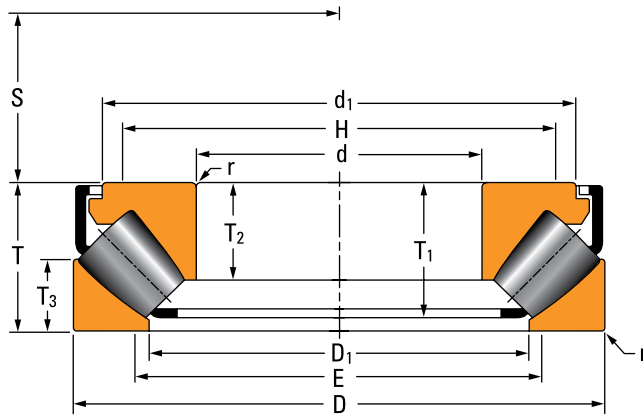

Type TSR-EJ

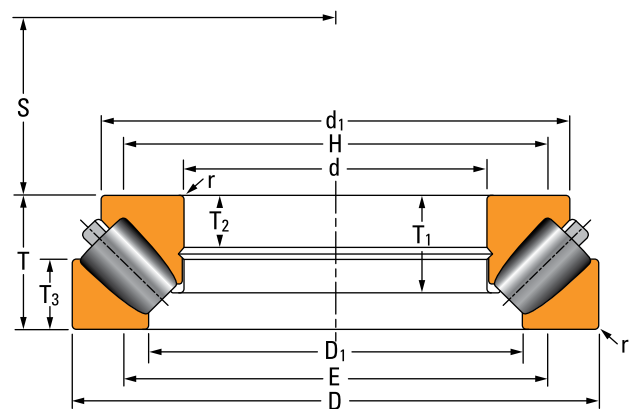

Type TSR-EM

TABLE 43. THRUST SPHERICAL ROLLER BEARINGS – continued

| Bearing Number | Bearing Dimensions | | | | | Shoulder Diameter | | Mounting Dimensions | | | | | Load Rating | | Thermal Speed Rating | Limiting Speed | Bearing Weight | Kc ⁽²⁾ |
|----------------|--------------------|-----------------|----------------|-----------------|-----------------|-------------------|----------------|---------------------|----------------|----------------|--------------|---------------------------------------|--------------------|---------------------|----------------------|----------------|------------------|-------------------|
| | Bore | O.D. | Width | Inner Ring O.D. | Outer Ring Bore | Housing (Max.) | Shaft (Min.) | T ₁ | T ₂ | T ₃ | S | Fillet ⁽¹⁾ Radius (Max.) r | Static Load Rating | Dynamic Load Rating | | | | |
| | d | D | T | d ₁ | D ₁ | E | H | | | | | | C _{a0} | C _a | | | | |
| mm in. | mm in. | mm in. | mm in. | mm in. | mm in. | mm in. | mm in. | mm in. | mm in. | mm in. | mm in. | mm in. | kN lbf. | kN lbf. | RPM | RPM | kg lbs. | |
| 29392EM | 460 18.1102 | 710 27.9528 | 150 5.9055 | 660 25.98 | 567 22.32 | 589 23.19 | 614 24.17 | 105.3 4.15 | 55 2.17 | 72.5 2.85 | 257 10.12 | 5 0.2 | 20200 4540000 | 4820 1080000 | 450 | 820 | 193.6 426.8 | 2165 |
| 29492EM | 460 18.1102 | 800 31.4961 | 206 8.1102 | 735 28.94 | 596 23.46 | 631 24.84 | 666 26.22 | 147.8 5.82 | 77 3.03 | 101.5 4 | 268 10.55 | 8 0.31 | 31700 7120000 | 8120 1830000 | 380 | 760 | 396.5 874.2 | 4875 |
| 29396EM | 480 18.8976 | 730 28.7402 | 150 5.9055 | 680 26.77 | 591 23.27 | 610 24.02 | 635 25 | 101.6 4 | 54 2.13 | 73.5 2.89 | 270 10.63 | 5 0.2 | 20000 4500000 | 4820 1080000 | 440 | 790 | 196.5 433.2 | 2305 |
| 29496EM | 480 18.8976 | 850 33.4646 | 224 8.8189 | 780 30.71 | 625 24.61 | 662 26.06 | 700 27.56 | 161.5 6.36 | 88 3.46 | 108 4.25 | 280 11.02 | 8 0.31 | 35800 8040000 | 9320 2090000 | 360 | 720 | 493.1 1087.2 | 6335 |
| 293/500EM | 500 19.685 | 750 29.5276 | 150 5.9055 | 700 27.56 | 611 24.06 | 630 24.8 | 655 25.79 | 101.5 4 | 54 2.13 | 74 2.91 | 280 11.02 | 5 0.2 | 20500 4620000 | 4840 1090000 | 430 | 760 | 202.9 447.4 | 2420 |
| 294/500EM | 500 19.685 | 870 34.252 | 224 8.8189 | 779 30.67 | 620 24.41 | 677 26.65 | 712 28.03 | 163 6.42 | 95.5 3.76 | 118 4.65 | 293 11.54 | 8 0.31 | 42370 9525000 | 10360 2328000 | 320 | 700 | 544 1200 | 7070 |
| 293/530EM | 530 20.8661 | 800 31.4961 | 160 6.2992 | 745 29.33 | 648 25.51 | 670 26.38 | 697 27.44 | 112.3 4.42 | 58 2.28 | 76 2.99 | 295 11.61 | 6 0.24 | 24100 5410000 | 5600 1260000 | 390 | 720 | 251.1 553.6 | 3220 |
| 294/530EM | 530 20.8661 | 920 36.2205 | 236 9.2913 | 823 32.4 | 657 25.87 | 716 28.19 | 753 29.65 | 171.4 6.75 | 93.7 3.69 | 124 4.88 | 310 12.21 | 8 0.31 | 47120 10593000 | 11440 2572000 | 300 | 660 | 609.5 1343.8 | 8830 |
| 293/560EM | 560 22.0472 | 850 33.4646 | 175 6.8898 | 790 31.1 | 690 27.17 | 712 28.03 | 740 29.13 | 119.1 4.69 | 63 2.48 | 85 3.35 | 310 12.21 | 6 0.24 | 26600 5990000 | 6180 1390000 | 370 | 680 | 309.8 683 | 4055 |
| 294/560EM | 560 22.0472 | 980 38.5827 | 250 9.8425 | 876 34.89 | 693 27.28 | 759 29.88 | 798.1 31.42 | 183.2 7.21 | 106.5 4.19 | 134 6.28 | 328 12.91 | 10 0.39 | 54370 12222000 | 13010 2926000 | 280 | 620 | 744.1 1640.4 | 11425 |
| 292/600EM | 600 23.622 | 800 31.4961 | 122 4.8031 | 750 29.53 | 677 26.65 | 699 27.52 | 718 28.27 | 82.9 3.26 | 40.6 1.598 | 64 2.52 | 322 12.68 | 4 0.16 | 21920 4927000 | 4370 981600 | 400 | 680 | 152 335.1 | 2355 |
| 293/600EM | 600 23.622 | 900 35.4331 | 180 7.0946 | 840 33.07 | 720 28.35 | 751 29.57 | 780 30.71 | 127.3 5.01 | 65 2.56 | 89 3.5 | 335 13.19 | 6 0.24 | 32700 7360000 | 7380 1660000 | 330 | 640 | 361.1 796.2 | 5465 |
| 294/600EM | 600 23.622 | 1030 40.5512 | 258 10.1575 | 922 36.3 | 744 29.29 | 805 31.69 | 847.1 33.35 | 186 7.32 | 107 4.21 | 134 5.28 | 351 13.82 | 10 0.39 | 57530 12933000 | 13840 3112000 | 260 | 590 | 822.3 1814.1 | 13750 |
| 292/630EM | 630 24.803 | 850 33.4646 | 132 5.1968 | 796 31.34 | 712 28.03 | 759 29.88 | 738 29.06 | 90.3 3.56 | 43.9 1.73 | 71.5 2.82 | 338 13.31 | 5 0.2 | 25800 5800000 | 5040 1133000 | 380 | 650 | 195 430 | 3090 |
| 294/630EM | 630 24.803 | 1090 42.9134 | 280 11.0236 | 975 38.39 | 780 30.71 | 849 33.43 | 893.1 35.16 | 203.1 8 | 114.2 4.5 | 146 5.75 | 367 14.45 | 10 0.39 | 65910 14816000 | 15640 3515000 | 240 | 560 | 1011.5 2230.1 | 17420 |
| 292/670EM | 670 26.378 | 900 35.4331 | 140 5.5118 | 865 34.06 | 773 30.43 | 792 31.18 | 813 32.01 | 89.5 3.52 | 44 1.73 | 73 2.87 | 363 14.29 | 5 0.2 | 22000 4940000 | 4290 965000 | 410 | 610 | 218.5 481.8 | 2790 |

(1) Maximum shaft or housing fillet radius that bearing corners will clear.

(2) Centrifugal force constant for induced thrust load calculation found on page 21.

Continued on next page.

THRUST SPHERICAL ROLLER BEARINGS – TYPE TSR-EJ AND TYPE TSR-EM

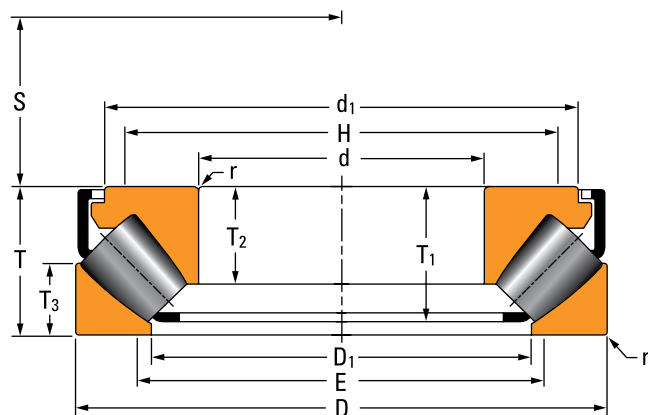

Type TSR-EJ

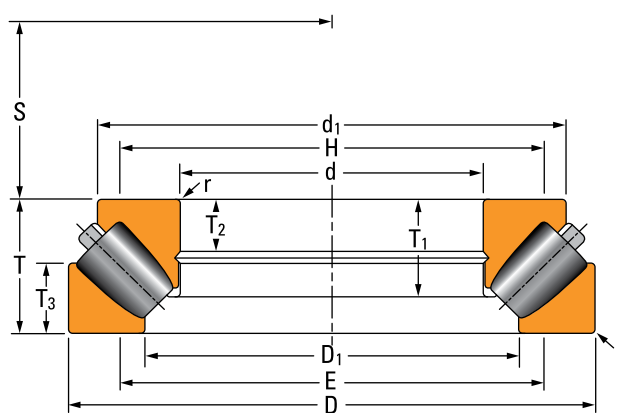

Type TSR-EM

Continued from previous page.

| Bearing Number | Bearing Dimensions | | | | | Shoulder Diameter | | Mounting Dimensions | | | | | Load Rating | | Thermal Speed Rating | Limiting Speed | Bearing Weight | Kc ⁽²⁾ |
|----------------|--------------------|-----------------|----------------|-----------------|-----------------|-------------------|-----------------|---------------------|----------------|----------------|-------------------------------------|--------------------|---------------------|------------------|----------------------|----------------|------------------|-------------------|
| | Bore | O.D. | Width | Inner Ring O.D. | Outer Ring Bore | Housing (Max.) | Shaft (Min.) | | | | Fillet ⁽¹⁾ Radius (Max.) | Static Load Rating | Dynamic Load Rating | | | | | |
| | d | D | T | d ₁ | D ₁ | E | H | T ₁ | T ₂ | T ₃ | S | r | C _{a0} | C _a | | | | |
| mm in. | mm in. | mm in. | mm in. | mm in. | mm in. | mm in. | mm in. | mm in. | mm in. | mm in. | mm in. | mm in. | kN lbf. | kN lbf. | RPM | RPM | kg lbs. | |
| 292/670EJ | 670 26.378 | 900 35.4331 | 140 5.5118 | 838.2 33 | 773 30.43 | 792 31.18 | 813 32.01 | 111.1 4.37 | 94 3.7 | 73 2.87 | 363 14.29 | 5 0.2 | 23100 5190000 | 4450 1000000 | 370 | 610 | 224 493.7 | 2925 |
| 294/670EM | 670 26.378 | 1150 45.2756 | 290 11.4173 | 1029 40.51 | 830 32.68 | 899 35.39 | 946 37.24 | 209.3 8.24 | 118 4.65 | 150 5.91 | 391 15.39 | 12 0.47 | 71970 16179000 | 17030 3829000 | 230 | 530 | 1159.4 2538.3 | 21420 |
| 294/710EM | 710 27.9528 | 1220 48.0315 | 308 12.126 | 1092 42.99 | 879 34.61 | 953 37.52 | 1003 39.49 | 222.6 8.76 | 122.7 4.83 | 160 6.3 | 414 16.3 | 12 0.47 | 81300 18276000 | 19060 4284000 | 210 | 500 | 1379.3 3040.8 | 27180 |
| 293/750EM | 750 29.5276 | 1120 44.0945 | 224 8.8189 | 1028 40.47 | 884 34.8 | 930 36.61 | 966 38.03 | 156.4 6.16 | 83.3 3.28 | 117 4.61 | 418 16.46 | 8 0.32 | 55860 12557000 | 11770 2647000 | 240 | 510 | 699.6 1542.2 | 14010 |
| 294/750EM | 750 29.5276 | 1280 50.3937 | 315 12.4016 | 1146 45.12 | 929 36.58 | 1002 39.45 | 1054 41.5 | 226.8 8.93 | 130.2 5.13 | 163 6.42 | 439 17.28 | 12 0.47 | 87900 19761000 | 20560 4621000 | 200 | 470 | 1537 3388.4 | 32685 |
| 294/800EM | 800 31.4961 | 1360 53.5433 | 335 13.189 | 1219 47.99 | 988 38.9 | 1067 42.01 | 1122 44.17 | 241.6 9.51 | 131.5 5.18 | 173.5 6.83 | 467 18.39 | 12 0.47 | 98280 22094000 | 22700 5104000 | 190 | 440 | 1836 4048 | 40935 |
| 294/850EM | 850 33.4646 | 1440 56.6929 | 354 13.9402 | 1290 50.79 | 1053 41.46 | 1131 44.53 | 1190 46.85 | 253.1 9.96 | 139.8 5.51 | 181 7.13 | 495 19.49 | 12 0.47 | 109310 24574000 | 25250 5677000 | 170 | 420 | 2156 4753 | 51670 |
| 294/850EJ | 850 33.4646 | 1440 56.6929 | 354 13.9402 | 1294 50.95 | 1045 41.14 | 1129 44.5 | 1171.1 46.11 | 309.5 12.18 | 224.7 8.85 | 185.5 7.3 | 495 19.49 | 12 0.47 | 112880 25377000 | 24650 5542000 | 170 | 420 | 2253 4969 | 50035 |
| 294/900EM | 900 35.4331 | 1520 59.8425 | 372 14.6457 | 1366 53.78 | 1098 43.23 | 1194 47.01 | 1253 49.33 | 272.1 10.71 | 148.8 5.86 | 195.5 7.7 | 523 20.59 | 12 0.47 | 126950 28540000 | 27440 6168000 | 160 | 400 | 2561 5646 | 63350 |
| 294/950EM | 950 37.4016 | 1600 62.9921 | 390 15.3543 | 1438 56.61 | 1162 45.75 | 1259 49.57 | 1321 52.01 | 284.6 11.21 | 155.4 6.12 | 204 8.03 | 552 21.73 | 12 0.47 | 139020 31253000 | 30600 6880000 | 150 | 370 | 2962.3 6530.8 | 77810 |
| 292/1000EM | 1000 39.3701 | 1320 51.9685 | 190 7.4803 | 1242 48.9 | 1118 44.02 | 1157 45.55 | 1187 46.73 | 131.1 5.16 | 68.1 2.68 | 102 4.02 | 539 21.22 | 8 0.31 | 59110 13288000 | 10580 2379000 | 230 | 410 | 633.3 1396.2 | 15850 |
| 293/1000EM | 1000 39.3701 | 1460 57.4803 | 276 10.8661 | 348 53.07 | 162 45.75 | 1268 49.92 | 1224 48.19 | 275.8 10.86 | 104.3 4.11 | 144.5 5.69 | 561 22.09 | 10 0.39 | 94280 21194000 | 18520 4163000 | 140 | 390 | 1426 3144 | 37215 |
| 294/1000EM | 1000 39.3701 | 1670 65.748 | 402 15.8268 | 1501 59.09 | 1225 48.23 | 1319 51.93 | 1385.1 54.53 | 289.9 11.41 | 162 6.38 | 208.5 8.21 | 580 22.84 | 12 0.47 | 148040 33280000 | 32590 7326000 | 140 | 360 | 3263.5 7194.7 | 91560 |

⁽¹⁾Maximum shaft or housing fillet radius that bearing corners will clear.

⁽²⁾Centrifugal force constant for induced thrust load calculation found on page 21.

THRUST TAPERED ROLLER BEARINGS TYPE TTHD

- Consists of two thrust tapered races, rollers and cage.
- Generally a heavy-duty bearing that can operate at relatively high speeds.
- Bearing of choice for axial positions in a wide variety of applications including oil well swivels, pulp refiners, extruders and piercing mill thrust blocks.

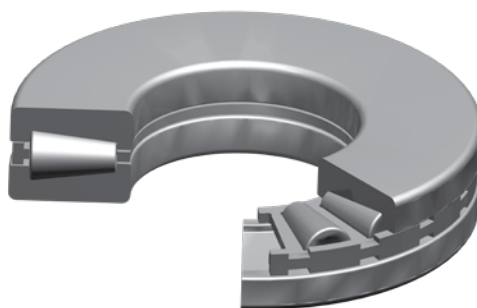

Fig. 71. Type TTHD thrust tapered roller bearing.

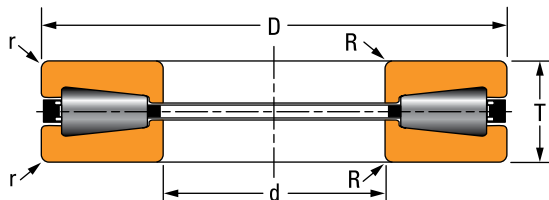

Fig. 72. Type TTHD thrust tapered roller bearing assembly.

OVERALL DIMENSIONS:

- d – Bore diameter
- D – Bearing O.D.
- T – Bearing width
- R – Shaft maximum fillet radius
- r – Housing maximum fillet radius

The design differences between the TTHD configurations shown on pages 94-98 are described as follows:

Fig. 1 – TTHD with full complement of rollers (cageless)

Fig. 2 – TTHD with cage

Fig. 3 – TTHD with cage, but no roller smaller-end ribs

Fig. 4 – TTHD with cage and I.D. corner reliefs

Fig. 5 – TTHD with full complement of rollers (cageless) and I.D. corner reliefs

THRUST BEARING DATA

THRUST TAPERED ROLLER BEARINGS – TYPE TTHD

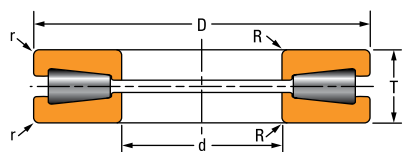

Fig. 1

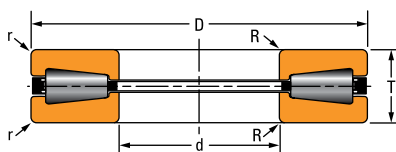

Fig. 2

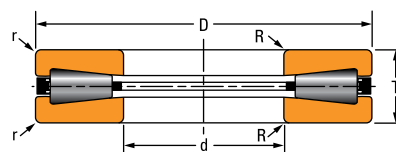

Fig. 3

TABLE 44. THRUST TAPERED ROLLER BEARINGS – TYPE TTHD

| Bearing Number | Figure Number | Bearing Dimensions | | | Fillet Radius ⁽¹⁾ | | Load Rating | | Bearing Weight |
|----------------------|---------------|--------------------|--------------------|------------------|------------------------------|----------------|--------------------|---------------------|----------------|
| | | Bore | O.D. | Width | Shaft (Max.) | Housing (Max.) | Static Load Rating | Dynamic Load Rating | |
| | | d | D | T | R | r | C _{a0} | C _{a90} | |
| | | mm in. | mm in. | mm in. | mm in. | mm in. | kN lbf. | kN lbf. | kg lbs. |
| T135 | 2 | 34.925 1.3750 | 76.200 3.0000 | 15.875 0.6250 | 1.5 0.06 | 1.5 0.06 | 320 71200 | 30 7130 | 0.4 0.8 |
| T135F ⁽³⁾ | 1 | 34.925 1.3750 | 76.200 3.0000 | 15.875 0.6250 | 1.5 0.06 | 1.5 0.06 | 470 105000 | 240 53500 | 0.4 0.9 |
| T1750 | 2 | 44.450 1.7500 | 84.734 3.3360 | 18.258 0.7188 | 2.3 0.09 | 2.3 0.09 | 430 97700 | 40 9460 | 0.5 1.1 |
| T200A | 2 | 50.800 2.0000 | 109.538 4.3125 | 22.225 0.8750 | 2.3 0.09 | 2.3 0.09 | 800 181000 | 70 16400 | 1.0 2.3 |
| T2520 | 2 | 63.500 2.5000 | 117.475 4.6250 | 25.400 1.0000 | 2.3 0.09 | 2.3 0.09 | 800 180000 | 80 16900 | 1.3 3.0 |
| 30TTHD013 | 3 | 76.200 3.0000 | 161.925 6.3750 | 33.325 1.3120 | 3.0 0.12 | 3.0 0.12 | 1800 405000 | 170 37900 | (2) |
| T311 | 2 | 76.200 3.0000 | 161.925 6.3750 | 33.338 1.3215 | 3.3 0.13 | 3.3 0.13 | 1760 395000 | 150 34200 | 3.5 7.7 |
| T311F ⁽³⁾ | 1 | 76.200 3.0000 | 161.925 6.3750 | 33.338 1.3215 | 3.3 0.13 | 3.3 0.13 | 2440 545000 | 1250 281000 | 3.5 7.8 |
| T411 | 2 | 101.600 4.0000 | 215.900 8.5000 | 46.038 1.8125 | 3.3 0.13 | 3.3 0.13 | 3030 682000 | 250 56800 | 8.9 19.6 |
| T411F ⁽³⁾ | 1 | 101.600 4.0000 | 215.900 8.5000 | 46.038 1.8125 | 3.3 0.13 | 3.3 0.13 | 4200 945000 | 2160 485000 | 8.9 19.6 |
| T441 | 2 | 111.760 4.4000 | 223.520 8.8000 | 55.880 2.2000 | 3.3 0.13 | 3.3 0.13 | 3230 727000 | 270 60700 | 11.4 25.1 |
| T441F ⁽³⁾ | 1 | 111.760 4.4000 | 223.520 8.8000 | 55.880 2.2000 | 3.3 0.13 | 3.3 0.13 | 4480 1010000 | 2300 515000 | 11.4 25.1 |
| T451 | 2 | 114.300 4.5000 | 250.825 9.8750 | 53.975 2.1250 | 4.0 0.16 | 4.0 0.16 | 4380 985000 | 350 79100 | 14.2 31.3 |
| T520 | 2 | 127.000 5.0000 | 250.825 9.8750 | 55.563 2.1875 | 4.8 0.19 | 4.8 0.19 | 3700 831000 | 310 69500 | 13.9 30.6 |
| F-530-A | 3 | 127.000 5.0000 | 266.700 10.5000 | 58.738 2.3125 | 3.8 0.15 | 3.8 0.15 | 4720 1060000 | 265 60100 | (2) |
| T511 | 2 | 127.000 5.0000 | 266.700 10.5000 | 58.738 2.3125 | 4.8 0.19 | 4.8 0.19 | 4580 1030000 | 370 83600 | 17.0 37.6 |

⁽¹⁾Maximum shaft or housing fillet radius that bearing corners will clear.

⁽²⁾Contact your Timken engineer for details.

⁽³⁾Published load ratings are breaker-block ratings. Consult your Timken engineer for use in application analysis.

Continued on next page.

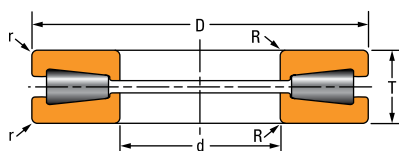

Fig. 1

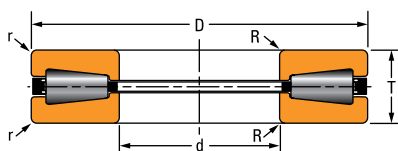

Fig. 2

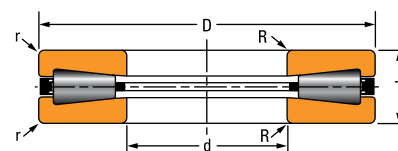

Fig. 3

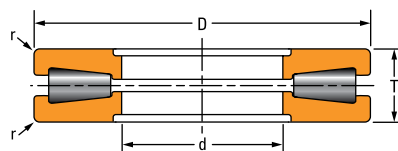

Fig. 5

Continued from previous page.

| Bearing Number | Figure Number | Bearing Dimensions | | | Fillet Radius ⁽¹⁾ | | Load Rating | | Bearing Weight |
|------------------------|---------------|--------------------|--------------------|-------------------|------------------------------|----------------|--------------------|---------------------|----------------|
| | | Bore | O.D. | Width | Shaft (Max.) | Housing (Max.) | Static Load Rating | Dynamic Load Rating | |
| | | d | D | T | R | r | C _{a0} | C _{a90} | |
| | | mm in. | mm in. | mm in. | mm in. | mm in. | kN lbf. | kN lbf. | kg lbs. |
| T511F ⁽³⁾ | 1 | 127.000 5.0000 | 266.700 10.5000 | 58.738 2.3125 | 4.8 0.19 | 4.8 0.19 | 6350 1430000 | 3260 730000 | 17.8 39.2 |
| T511A | 2 | 128.588 5.0625 | 266.700 10.5000 | 58.738 2.3125 | 4.8 0.19 | 4.8 0.19 | 4580 1030000 | 370 83600 | 17.8 39.2 |
| T9250FA ⁽³⁾ | 5 | 139.700 5.5000 | 546.100 21.5000 | 127.000 5.0000 | 1.5 0.06 | 16.0 0.63 | 31200 7050000 | 16050 3600000 | 191.3 421.8 |
| N-3247-A | 3 | 152.400 6.0000 | 292.100 11.5000 | 76.200 3.0000 | 6.4 0.25 | 6.4 0.25 | 5120 1150000 | 370 83680 | 26.3 58.0 |
| T611 | 2 | 152.400 6.0000 | 317.500 12.5000 | 69.850 2.7500 | 6.4 0.25 | 6.4 0.25 | 6660 1500000 | 530 118000 | 28.4 62.5 |
| T611F ⁽³⁾ | 1 | 152.400 6.0000 | 317.500 12.5000 | 69.850 2.7500 | 6.4 0.25 | 6.4 0.25 | 9200 2070000 | 4750 1060000 | 29.3 64.6 |
| N-3255-A | 3 | 152.400 6.0000 | 317.500 12.5000 | 88.900 3.5000 | 7.9 0.31 | 7.9 0.31 | 6810 1530000 | 470 106200 | 38.8 85.5 |
| XC2107 | 2 | 165.075 6.4990 | 304.800 12.0000 | 76.200 3.0000 | 6.4 0.25 | 6.4 0.25 | 5340 1200000 | 440 99300 | 26.3 57.9 |
| T651 | 2 | 165.100 6.5000 | 311.150 12.2500 | 88.900 3.5000 | 6.4 0.25 | 6.4 0.25 | 5730 1290000 | 470 105000 | 38.3 84.4 |
| T661 | 2 | 168.275 6.6250 | 304.800 12.0000 | 69.850 2.7500 | 6.4 0.25 | 6.4 0.25 | 5340 1200000 | 440 99300 | 23.5 51.9 |
| T691 | 2 | 174.625 6.8750 | 358.775 14.1250 | 82.550 3.2500 | 6.4 0.25 | 6.4 0.25 | 7870 1770000 | 620 139000 | 43.2 95.2 |
| T711 | 2 | 177.800 7.0000 | 368.300 14.5000 | 82.550 3.2500 | 8.0 0.31 | 8.0 0.31 | 8950 2010000 | 690 156000 | 48.4 106.7 |
| T711F ⁽³⁾ | 1 | 177.800 7.0000 | 368.300 14.5000 | 82.550 3.2500 | 8.0 0.31 | 8.0 0.31 | 12400 2790000 | 6350 1430000 | 48.4 106.7 |
| T709 | 3 | 177.800 7.0000 | 431.800 17.0000 | 101.600 4.0000 | 6.4 0.25 | 6.4 0.25 | 13600 3060000 | 1030 231000 | 86.3 190.3 |
| T7519 | 2 | 190.000 7.4803 | 355.600 14.0000 | 74.219 2.9220 | 6.4 0.25 | 6.4 0.25 | 6950 1560000 | 560 127000 | 35.9 79.2 |
| A-3783-B | 3 | 190.000 7.4803 | 355.600 14.0000 | 91.821 3.6150 | 4.0 0.16 | 4.0 0.16 | 8710 1960000 | 620 139000 | 49.0 108.0 |

⁽¹⁾Maximum shaft or housing fillet radius that bearing corners will clear.

⁽²⁾Contact your Timken engineer for details.

⁽³⁾Published load ratings are breaker-block ratings. Consult your Timken engineer for use in application analysis.

Continued on next page.

THRUST BEARING DATA

THRUST TAPERED ROLLER BEARINGS – TYPE TTHD

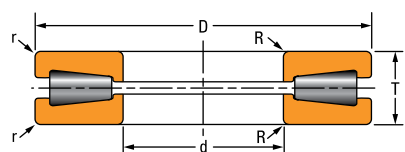

Fig. 1

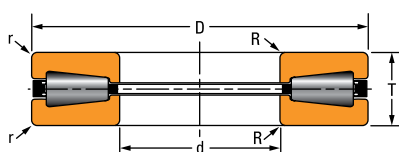

Fig. 2

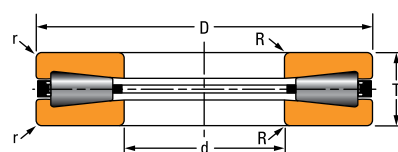

Fig. 3

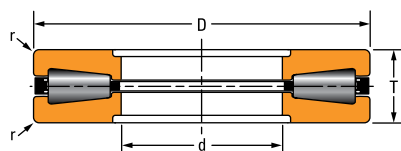

Fig. 4

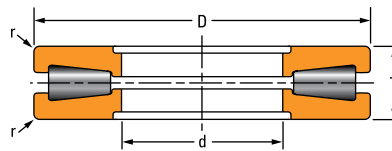

Fig. 5

TABLE 44. THRUST TAPERED ROLLER BEARINGS – TYPE TTHD – continued

| Bearing Number | Figure Number | Bearing Dimensions | | | Fillet Radius ⁽¹⁾ | | Load Rating | | Bearing Weight |
|-----------------------|---------------|--------------------|--------------------|-------------------|------------------------------|----------------|--------------------|---------------------|----------------|
| | | Bore | O.D. | Width | Shaft (Max.) | Housing (Max.) | Static Load Rating | Dynamic Load Rating | |
| | | d | D | T | R | r | C _{a0} | C _{a90} | |
| | | mm in. | mm in. | mm in. | mm in. | mm in. | kN lbf. | kN lbf. | kg lbs. |
| N-3239-A | 3 | 190.500 7.5000 | 368.300 14.5000 | 95.250 3.7500 | 11.2 0.44 | 11.2 0.44 | 9250 2080000 | 750 169000 | 53.0 117.0 |
| XC2108 | 2 | 203.150 7.9980 | 396.875 15.6250 | 130.175 5.1250 | 9.7 0.38 | 9.7 0.38 | 9700 2180000 | 690 154000 | 83.7 184.6 |
| T811 | 2 | 203.200 8.0000 | 419.100 16.5000 | 92.075 3.6250 | 9.7 0.38 | 9.7 0.38 | 11400 2560000 | 870 195000 | 65.5 144.3 |
| T811F ⁽³⁾ | 1 | 203.200 8.0000 | 419.100 16.5000 | 92.075 3.6250 | 9.7 0.38 | 9.7 0.38 | 15750 3540000 | 8100 1820000 | 69.3 152.8 |
| T811V | 2 | 203.200 8.0000 | 419.100 16.5000 | 92.075 3.6250 | 9.7 0.38 | 9.7 0.38 | 11400 2560000 | 870 195000 | 65.5 144.5 |
| N-3263-A | 3 | 206.375 8.1250 | 419.100 16.5000 | 120.650 4.7500 | 11.9 0.47 | 11.9 0.47 | 13000 2920000 | 970 219000 | 90.7 200.0 |
| XC760 | 2 | 206.375 8.1250 | 419.100 16.5000 | 120.650 4.7500 | 9.7 0.38 | 9.7 0.38 | 11400 2560000 | 870 195000 | 88.2 194.5 |
| T9020 | 4 | 228.600 9.0000 | 431.800 17.0000 | 88.773 3.4950 | 1.5 0.06 | 9.7 0.38 | 10900 2450000 | 850 192000 | 65.7 144.8 |
| T911 | 4 | 228.600 9.0000 | 482.600 19.0000 | 104.775 4.1250 | 1.5 0.06 | 11.2 0.44 | 15200 3420000 | 1140 256000 | 98.3 216.6 |
| T911F ⁽³⁾ | 5 | 228.600 9.0000 | 482.600 19.0000 | 104.775 4.1250 | 1.5 0.06 | 11.2 0.44 | 21200 4750000 | 10850 2440000 | 97.9 215.9 |
| T911A | 4 | 234.950 9.2500 | 482.600 19.0000 | 104.775 4.1250 | 1.5 0.06 | 11.2 0.44 | 15200 3420000 | 1140 256000 | 103.0 227.1 |
| T921 | 4 | 234.950 9.2500 | 546.100 21.5000 | 127.000 5.0000 | 1.5 0.06 | 16.0 0.63 | 21300 4780000 | 1570 353000 | 171.0 377.0 |
| T921F ⁽³⁾ | 5 | 234.950 9.2500 | 546.100 21.5000 | 127.000 5.0000 | 1.5 0.06 | 16.0 0.63 | 30000 6750000 | 15550 3500000 | 171.0 377.0 |
| T9250F ⁽³⁾ | 5 | 234.950 9.2500 | 546.100 21.5000 | 127.000 5.0000 | 1.5 0.06 | 16.0 0.63 | 31200 7050000 | 16050 3600000 | 164.8 363.4 |
| N-3235-A | 3 | 241.300 9.5000 | 495.300 19.5000 | 127.000 5.0000 | 11.2 0.44 | 11.2 0.44 | 18600 4180000 | 1320 298000 | 140.0 308.0 |
| N-3517-A | 3 | 241.300 9.5000 | 495.300 19.5000 | 127.000 5.0000 | 12.7 0.50 | 12.7 0.50 | 19000 4280000 | 1590 357000 | 137.0 303.0 |

⁽¹⁾Maximum shaft or housing fillet radius that bearing corners will clear.

⁽²⁾Contact your Timken engineer for details.

⁽³⁾Published load ratings are breaker-block ratings. Consult your Timken engineer for use in application analysis.

Continued on next page.

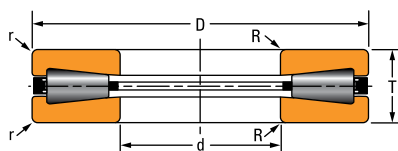

Fig. 3

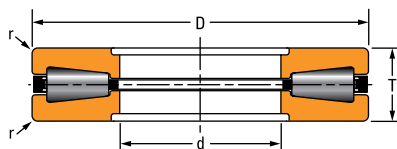

Fig. 4

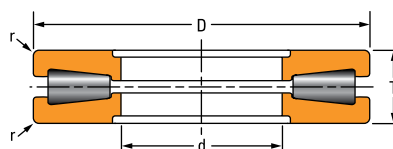

Fig. 5

Continued from previous page.

| Bearing Number | Figure Number | Bearing Dimensions | | | Fillet Radius ⁽¹⁾ | | Load Rating | | Bearing Weight |
|------------------------|---------------|--------------------|--------------------|-------------------|------------------------------|----------------|--------------------|---------------------|-----------------|
| | | Bore | O.D. | Width | Shaft (Max.) | Housing (Max.) | Static Load Rating | Dynamic Load Rating | |
| | | d | D | T | R | r | C _{a0} | C _{a90} | |
| | | mm in. | mm in. | mm in. | mm in. | mm in. | kN lbf. | kN lbf. | kg lbs. |
| T1011 | 4 | 254.000 10.0000 | 539.750 21.2500 | 117.475 4.6250 | 1.5 0.06 | 11.2 0.44 | 19400 4350000 | 1420 319000 | 147.0 324.1 |
| N-3243-A | 3 | 273.050 10.7500 | 552.450 21.7500 | 133.350 5.2500 | 11.2 0.44 | 11.2 0.44 | 22400 5030000 | 1650 371000 | 173.0 381.0 |
| N-3259-A | 3 | 273.050 10.7500 | 566.674 22.3100 | 177.800 7.0000 | 14.7 0.58 | 14.7 0.58 | 24900 5590000 | 1750 393000 | 254.0 559.0 |
| N-3251-A | 3 | 273.050 10.7500 | 603.250 23.7500 | 146.050 5.7500 | 11.2 0.44 | 11.2 0.44 | 27700 6230000 | 2000 449000 | 240.0 528.0 |
| N-3513-A | 3 | 273.050 10.7500 | 603.250 23.7500 | 146.050 5.7500 | 12.7 0.50 | 12.7 0.50 | 27900 6260000 | 2220 498000 | 235.0 518.0 |
| T1115 | 4 | 279.400 11.0000 | 495.300 19.5000 | 133.350 5.2500 | 1.5 0.06 | 6.4 0.25 | 14000 3150000 | 1090 245000 | 125.0 275.6 |
| T1120 | 4 | 279.400 11.0000 | 603.250 23.7500 | 136.525 5.3750 | 1.5 0.06 | 11.2 0.44 | 25300 5690000 | 1810 408000 | 212.0 467.4 |
| T1120F ⁽³⁾ | 5 | 279.400 11.0000 | 603.250 23.7500 | 136.525 5.3750 | 1.5 0.06 | 11.2 0.44 | 35000 7870000 | 18000 4040000 | 212.0 467.4 |
| T1421 | 4 | 355.600 14.0000 | 533.400 21.0000 | 101.600 4.0000 | 1.5 0.06 | 6.4 0.25 | 12100 2710000 | 840 189000 | 82.9 182.7 |
| T1421F ⁽³⁾ | 5 | 355.600 14.0000 | 533.400 21.0000 | 101.600 4.0000 | 1.5 0.06 | 6.4 0.25 | 17200 3870000 | 8000 1790000 | 84.1 185.4 |
| G-2308-B | 3 | 355.600 14.0000 | 622.300 24.5000 | 115.888 4.5625 | 11.2 0.44 | 11.2 0.44 | 26500 5950000 | 1860 419000 | (2) |
| T14520 | 4 | 368.300 14.5000 | 603.300 23.7500 | 120.650 4.7500 | 1.5 0.06 | 9.7 0.38 | 18100 4060000 | 1420 319000 | 144.0 317.5 |
| T16021 | 4 | 406.400 16.0000 | 711.200 28.0000 | 146.050 5.7500 | 1.5 0.06 | 9.7 0.38 | 29000 6530000 | 2130 480000 | 259.6 572.4 |
| T16021F ⁽³⁾ | 5 | 406.400 16.0000 | 711.200 28.0000 | 146.050 5.7500 | 1.5 0.06 | 9.7 0.38 | 38200 8600000 | 19600 4400000 | 264.0 582.0 |
| T16050 | 4 | 406.400 16.0000 | 838.200 33.0000 | 177.800 7.0000 | 1.5 0.06 | 12.7 0.50 | 48000 10800000 | 3320 747000 | 517.0 1139.8 |
| T16050F ⁽³⁾ | 5 | 406.400 16.0000 | 838.200 33.0000 | 177.800 7.0000 | 1.5 0.06 | 12.7 0.50 | 66500 15000000 | 34200 7650000 | 501.5 1106.0 |

⁽¹⁾Maximum shaft or housing fillet radius that bearing corners will clear.

⁽²⁾Contact your Timken engineer for details.

⁽³⁾Published load ratings are breaker-block ratings. Consult your Timken engineer for use in application analysis.

Continued on next page.

THRUST BEARING DATA

THRUST TAPERED ROLLER BEARINGS – TYPE TTHD

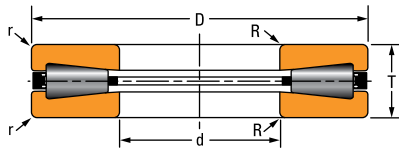

Fig. 3

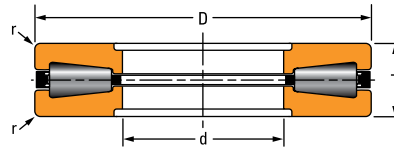

Fig. 4

TABLE 44. THRUST TAPERED ROLLER BEARINGS – TYPE TTHD – continued

| Bearing Number | Figure Number | Bearing Dimensions | | | Fillet Radius ⁽¹⁾ | | Load Rating | | Bearing Weight |
|----------------|---------------|---------------------|---------------------|-------------------|------------------------------|---------------------|---------------------------------------|---|-----------------|
| | | Bore d | O.D. D | Width T | Shaft (Max.) R | Housing (Max.) r | Static Load Rating C _{a0} | Dynamic Load Rating C _{a90} | |
| | | mm in. | mm in. | mm in. | mm in. | mm in. | kN lbf. | kN lbf. | kg lbs. |
| B-8948-G | 4 | 406.400 16.0000 | 914.400 36.0000 | 190.500 7.5000 | 5.0 0.20 | 5.0 0.20 | 81000 18200000 | 5430 1220000 | 721.0 1590.0 |
| T20020 | 4 | 508.000 20.0000 | 990.600 39.0000 | 196.850 7.7500 | 1.5 0.06 | 1.5 0.06 | 66700 15000000 | 4530 1020000 | 735.0 1620.0 |
| XC2102 | 3 | 1003.070 39.4910 | 1117.600 44.0000 | 50.800 2.0000 | 3.3 0.13 | 3.3 0.13 | 14900 3350000 | 530 119000 | 64.2 141.4 |
| XC2101 | 3 | 1162.050 45.7500 | 1282.700 50.5000 | 52.388 2.0625 | 3.3 0.13 | 3.3 0.13 | 19000 4280000 | 620 139000 | 79.9 176.2 |
| T48000 | 4 | 1219.200 48.0000 | 1524.000 60.0000 | 136.525 5.3750 | 1.5 0.06 | 9.7 0.38 | 74800 16800000 | 3450 775000 | 596.0 1314.0 |

⁽¹⁾Maximum shaft or housing fillet radius that bearing corners will clear.

⁽²⁾Contact your Timken engineer for details.

⁽³⁾Published load ratings are breaker-block ratings. Consult your Timken engineer for use in application analysis.

TYPE TTHDFL

- Consists of one thrust tapered race, one flat race, rollers and cage.
- Most sizes utilize pin-type cages with hardened pins through the center of the rollers, allowing closer roller spacing to maximize load capacity.
- Smaller sizes have brass cages designed for unidirectional retention of rollers.
- Combines the outstanding features of thrust tapered and cylindrical roller bearings to offer the highest possible load capacity of any thrust bearing of its size.
- Originally developed for screwdown applications in metal rolling mills where high axial loads are common.

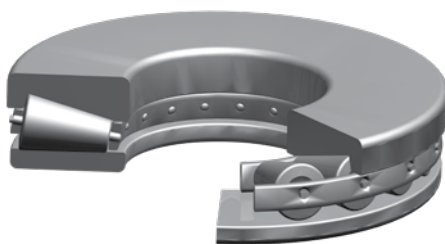

Fig. 73. Type TTHDFL thrust tapered roller bearing.

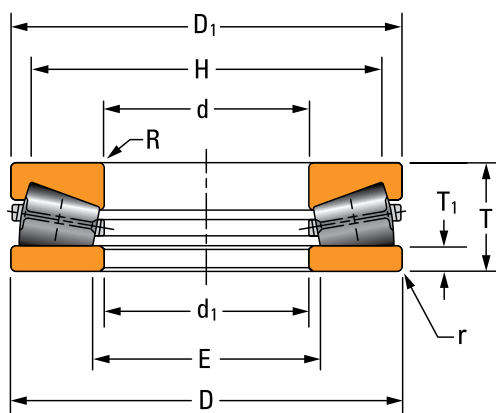

Fig. 74. Type TTHDFL thrust tapered roller bearing assembly.

OVERALL DIMENSIONS:

- d – Bore diameter
- D – Bearing O.D.
- T – Bearing width
- T₁ – Ring thickness
- d₁ – Large bore I.D.
- D₁ – Small diameter O.D.
- E – Housing shoulder diameter
- H – Shaft shoulder diameter
- R – Shaft maximum fillet radius
- r – Housing maximum fillet radius

THRUST BEARING DATA

THRUST TAPERED ROLLER BEARINGS – TYPE TTHDFL

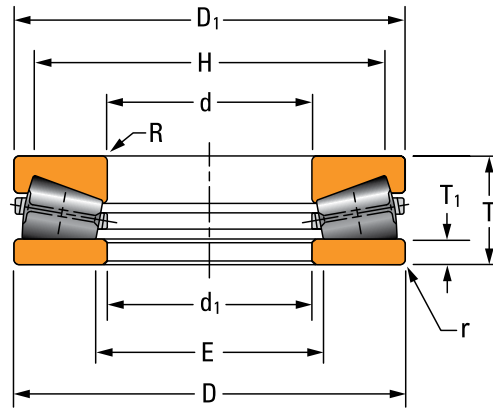

TABLE 45. THRUST TAPERED ROLLER BEARINGS – TYPE TTHDFL

| Bearing Number | Bearing Dimensions | | | Rings | | | Fillet Radius ⁽¹⁾ | | Shoulder Diameter | | Load Rating | | Bearing Weight |
|-----------------|--------------------|--------------------|-------------------|----------------|---------------------|-----------------|------------------------------|----------------|-------------------|----------------|--------------------|---------------------|----------------|
| | Bore | O.D. | Width | Thickness | Small Diameter O.D. | Large Bore I.D. | Shaft (Max.) | Housing (Max.) | Shaft (Min.) | Housing (Max.) | Static Load Rating | Dynamic Load Rating | |
| | d | D | T | T ₁ | D ₁ | d ₁ | R | r | H | E | C ₁₀ | C ₉₀ | |
| | mm in. | mm in. | mm in. | mm in. | mm in. | mm in. | mm in. | mm in. | mm in. | mm in. | kN lbf. | kN lbf. | kg lbs. |
| C-8515-A | 76.200 3.0000 | 161.925 6.3750 | 33.325 1.3120 | 7.62 0.300 | 161.93 6.375 | 76.20 3.000 | 2.5 0.10 | 2.5 0.10 | 150.5 5.93 | 88.6 3.49 | 2600 584000 | 200 44300 | 3.5 7.6 |
| W-3490-A | 88.900 3.5000 | 190.500 7.5000 | 50.800 2.0000 | 8.26 0.325 | 188.93 7.438 | 92.08 3.625 | 3.3 0.13 | 3.3 0.13 | 169.4 6.67 | 105.7 4.16 | 2450 551000 | 250 56500 | 7.1 15.6 |
| N-3568-A | 101.600 4.0000 | 247.650 9.7500 | 66.675 2.6250 | 12.70 0.500 | 247.65 9.750 | 101.60 4.000 | 3.6 0.14 | 3.6 0.14 | 222.0 8.74 | 120.7 4.75 | 5130 1153000 | 390 87800 | 18.0 39.0 |
| 120TTVF85 00487 | 120.000 4.7244 | 300.000 11.8110 | 79.000 3.1103 | 16.51 0.650 | 298.50 11.752 | 125.00 4.921 | 4.0 0.16 | 4.0 0.16 | 270.7 10.66 | 148.5 5.85 | 7310 1640000 | 620 140000 | 31.8 70.0 |
| T4920 | 124.993 4.9210 | 185.738 7.3125 | 25.400 1.0000 | 6.60 0.260 | 185.74 7.313 | 124.99 4.921 | 1.5 0.06 | 2.0 0.08 | 172.9 6.81 | 135.1 5.32 | 1250 282000 | 90 21000 | 2.4 5.2 |
| N-3586-A | 126.962 4.9985 | 279.400 11.0000 | 58.738 2.3125 | 11.43 0.450 | 279.40 11.000 | 133.35 5.250 | 5.6 0.22 | 5.6 0.22 | 255.3 10.05 | 146.1 5.75 | 7020 1580000 | 520 117000 | 18.4 40.6 |
| W-3217-B | 127.000 5.0000 | 266.700 10.5000 | 58.738 2.3125 | 12.70 0.500 | 265.94 10.470 | 127.51 5.020 | 3.6 0.14 | 3.6 0.14 | 240.3 9.46 | 143.4 5.65 | 4780 1080000 | 400 89000 | 16.9 37.3 |
| D-3461-C | 127.000 5.0000 | 266.700 10.5000 | 58.738 2.3125 | 12.70 0.500 | 265.94 10.470 | 127.51 5.020 | 3.5 0.14 | 3.5 0.14 | 240.5 9.47 | 148.5 5.85 | 4780 1080000 | 400 89000 | 17.0 37.4 |
| T660V | 168.275 6.6250 | 304.800 12.0000 | 69.850 2.7500 | 21.92 0.863 | 304.80 12.000 | 168.28 6.625 | 6.4 0.25 | 6.4 0.25 | 274.0 10.79 | 180.9 7.12 | 6510 1460000 | 490 111000 | 23.7 52.2 |
| G-3304-B | 168.275 6.6250 | 304.800 12.0000 | 69.850 2.7500 | 14.29 0.562 | 303.21 11.938 | 171.45 6.750 | 6.4 0.25 | 6.4 0.25 | 277.8 10.94 | 188.9 7.44 | 7170 1610000 | 580 130000 | 25.90 57.00 |
| S-4059-B | 174.625 6.8750 | 358.775 14.1250 | 82.550 3.2500 | 17.48 0.688 | 358.78 14.125 | 176.21 6.938 | 4.8 0.19 | 4.8 0.19 | 325.4 12.81 | 203.2 8.00 | 5570 1252000 | 2660 597000 | 48.0 105.0 |
| W-3218-B | 177.800 7.0000 | 368.300 14.5000 | 82.169 3.2500 | 17.46 0.688 | 366.71 14.438 | 180.98 7.125 | 6.1 0.31 | 6.1 0.31 | 336.6 13.25 | 203.2 8.00 | 11900 1405500 | 880 660500 | 48.6 107.1 |
| C-8435-A | 177.800 7.0000 | 368.300 14.5000 | 82.550 3.2500 | 17.45 0.688 | 366.67 14.436 | 180.98 7.125 | 7.9 0.31 | 7.9 0.31 | 366.5 13.25 | 203.2 8.00 | 11900 2670000 | 880 198000 | 49.0 109.0 |
| G-3353-B | 177.800 7.0000 | 368.300 14.5000 | 82.550 3.2500 | 17.48 0.688 | 364.75 14.360 | 180.98 7.125 | 6.1 0.24 | 6.1 0.24 | 336.6 13.25 | 203.2 8.00 | 11250 2530000 | 760 171000 | 49.0 109.0 |
| N-3559-A | 177.800 7.0000 | 412.750 16.2500 | 111.125 4.3750 | 19.05 0.750 | 419.10 16.500 | 190.50 7.500 | 14.7 0.58 | 7.6 0.30 | 374.7 14.75 | 215.9 8.50 | 13000 2920000 | 1060 237000 | 91.6 202.0 |
| B-8809-C | 200.000 7.8745 | 405.643 15.9700 | 111.125 4.3750 | 25.40 1.000 | 396.85 15.624 | 203.20 8.000 | 4.0 0.16 | 4.0 0.16 | 360.0 14.17 | 228.6 9.00 | 13000 2920000 | 1060 237000 | 78.0 155.7 |
| N-3553-A | 203.200 8.0000 | 419.100 16.5000 | 92.075 3.6250 | 15.88 0.625 | 419.10 16.500 | 203.20 8.000 | 11.2 0.44 | 11.2 0.44 | 379.7 14.95 | 231.9 9.13 | 13700 3070000 | 1070 241000 | 62.0 137.0 |

⁽¹⁾Maximum shaft or housing fillet radius that bearing corners will clear.

⁽²⁾Bearing includes special features; contact your Timken engineer for details.

Continued on next page.

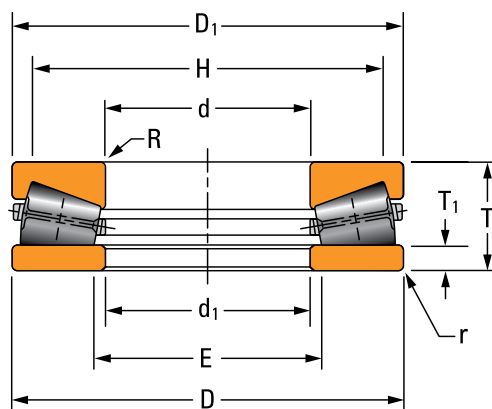

Continued from previous page.

| Bearing Number | Bearing Dimensions | | | Rings | | | Fillet Radius ⁽¹⁾ | | Shoulder Diameter | | Load Rating | | Bearing Weight |
|----------------|--------------------|--------------------|-------------------|----------------|---------------------|------------------|------------------------------|----------------|-------------------|----------------|--------------------|---------------------|------------------|
| | Bore | O.D. | Width | Thickness | Small Diameter O.D. | Large Bore I.D. | Shaft (Max.) | Housing (Max.) | Shaft (Min.) | Housing (Max.) | Static Load Rating | Dynamic Load Rating | |
| | d | D | T | T ₁ | D ₁ | d ₁ | R | r | H | E | C _{a0} | C _{a90} | |
| | mm in. | mm in. | mm in. | mm in. | mm in. | mm in. | mm in. | mm in. | mm in. | mm in. | kN lbf. | kN lbf. | kg lbs. |
| T-6240-A | 228.600 9.0000 | 482.600 19.0000 | 104.775 4.1250 | 22.61 0.890 | 482.60 19.000 | 228.60 9.000 | 4.1 0.16 | 11.2 0.44 | 449.3 17.69 | 255.3 10.05 | 20400 4590000 | 1430 320000 | 93.0 205.0 |
| V-463-A | 234.950 9.2500 | 546.100 21.5000 | 152.400 6.0000 | 25.40 1.000 | 546.10 21.500 | 244.48 9.625 | 14.7 0.58 | 9.1 0.36 | 492.5 19.39 | 271.3 10.68 | 30900 6950000 | 2310 519000 | 200.5 442.0 |
| N-3506-A | 241.300 9.5000 | 552.450 21.7500 | 139.700 5.5000 | 25.40 1.000 | 549.28 21.625 | 246.08 9.688 | 7.6 0.30 | 7.6 0.30 | 502.9 19.80 | 279.4 11.00 | 31100 6990000 | 2220 499000 | 186.0 410.0 |
| N-3560-A | 241.300 9.5000 | 584.200 23.0000 | 152.400 6.0000 | 31.75 1.250 | 581.03 22.875 | 246.08 9.688 | 7.6 0.30 | 7.6 0.30 | 526.0 20.71 | 279.4 11.00 | 33700 7580000 | 2450 551000 | 284.8 480.5 |
| I-2077-C | 253.975 9.9990 | 508.000 20.0000 | 95.250 3.7500 | 19.05 0.750 | 507.19 19.968 | 256.38 10.094 | 6.4 0.25 | 6.4 0.25 | 468.3 18.44 | 282.6 11.12 | 19600 4400000 | 1370 307000 | 110.20 243.00 |
| C-8326-A | 254.000 10.0000 | 508.000 20.0000 | 107.950 4.2500 | 21.44 0.844 | 506.43 19.938 | 257.18 10.125 | 4.8 0.19 | 4.8 0.19 | 466.9 18.38 | 287.0 11.30 | 22500 5050000 | 1590 358000 | 105.6 232.9 |
| C-8184-A | 254.000 10.0000 | 546.100 21.5000 | 127.000 5.0000 | 25.40 1.000 | 544.53 21.438 | 257.18 10.125 | 4.8 0.19 | 4.8 0.19 | 504.4 19.86 | 288.9 11.38 | 28300 6370000 | 2030 457000 | 152.9 337.0 |
| T10100V | 256.540 10.1000 | 546.100 21.5000 | 164.719 6.4850 | 38.22 1.505 | 542.93 21.375 | 256.54 10.100 | 1.5 0.06 | 6.4 0.25 | 485.1 19.10 | 299.5 11.79 | 28300 6370000 | 2070 465000 | 203.5 448.6 |
| G-3224-C | 256.540 10.1000 | 546.100 21.5000 | 165.100 6.5000 | 34.92 1.375 | 542.92 21.375 | 258.76 10.188 | 6.1 0.24 | 6.1 0.24 | 515.9 20.31 | 301.6 11.88 | 28400 6390000 | 2290 515000 | 227.20 501.00 |
| G-3291-C | 256.540 10.1000 | 546.100 21.5000 | 165.100 6.5000 | 34.93 1.375 | 542.93 21.375 | 258.78 10.188 | 7.9 0.31 | 7.9 0.31 | 485.0 19.09 | 301.6 11.88 | 28400 6390000 | 2290 515000 | 212.3 479.0 |
| S-4077-C | 259.999 10.2362 | 479.948 18.8956 | 132.080 5.2000 | 26.99 1.062 | 478.36 18.833 | 263.17 10.361 | 4.8 0.19 | 4.8 0.19 | 427 16.81 | 300 11.81 | 16500 3710000 | 1390 312000 | 126.50 279.00 |
| N-3580-A | 273.050 10.7500 | 609.600 24.0000 | 161.925 6.3750 | 31.75 1.250 | 609.60 24.000 | 292.10 11.500 | 6.4 0.25 | 6.4 0.25 | 556.0 21.89 | 316.7 12.47 | 35000 7880000 | 2630 591000 | 252.0 541.3 |
| T11000 | 279.400 11.0000 | 603.250 23.7500 | 136.525 5.3750 | 38.10 1.500 | 601.70 23.689 | 282.58 11.125 | 1.5 0.06 | 11.2 0.44 | 543.5 21.40 | 313.8 12.35 | 32200 7240000 | 2090 469000 | 202.6 446.7 |
| T11001V | 279.400 11.0000 | 603.250 23.7500 | 136.525 5.3750 | 38.10 1.500 | 603.25 23.750 | 279.40 11.000 | 1.5 0.06 | 11.2 0.44 | 543.5 21.40 | 313.8 12.35 | 32200 7240000 | 2570 577000 | 203.3 448.2 |
| T11002V | 279.400 11.0000 | 603.250 23.7500 | 136.525 5.3750 | 38.10 1.500 | 603.25 23.750 | 279.40 11.000 | 1.5 0.06 | 11.2 0.44 | 543.5 21.40 | 313.8 12.35 | 32200 7240000 | 2570 577000 | 203.3 448.1 |
| C-7964-C | 279.400 11.0000 | 603.250 23.7500 | 136.525 5.3750 | 29.36 1.156 | 628.65 24.750 | 282.58 11.125 | 4.8 0.19 | 4.8 0.19 | 577.9 22.75 | 317.5 12.50 | 38700 8700000 | 2530 568000 | 230.0 506.0 |
| C-8091-C | 279.400 11.0000 | 603.250 23.7500 | 136.525 5.3750 | 30.16 1.188 | 601.66 23.688 | 282.58 11.125 | 11.2 0.44 | 4.8 0.19 | 552.4 21.75 | 317.5 12.50 | 33300 7500000 | 2270 511000 | 202.7 446.9 |

⁽¹⁾Maximum shaft or housing fillet radius that bearing corners will clear.

⁽²⁾Bearing includes special features; contact your Timken engineer for details.

Continued on next page.

THRUST BEARING DATA

THRUST TAPERED ROLLER BEARINGS – TYPE TTHDFL

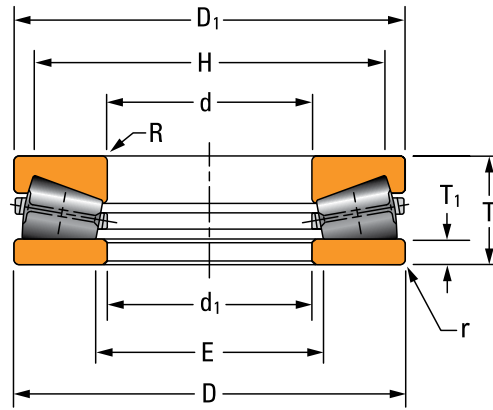

TABLE 45. THRUST TAPERED ROLLER BEARINGS – TYPE TTHDFL – continued

| Bearing Number | Bearing Dimensions | | | Rings | | | Fillet Radius ⁽¹⁾ | | Shoulder Diameter | | Load Rating | | Bearing Weight |
|----------------|--------------------|---------------------|--------------------|----------------|---------------------|------------------|------------------------------|----------------|-------------------|----------------|--------------------|---------------------|-------------------|
| | Bore | O.D. | Width | Thickness | Small Diameter O.D. | Large Bore I.D. | Shaft (Max.) | Housing (Max.) | Shaft (Min.) | Housing (Max.) | Static Load Rating | Dynamic Load Rating | |
| | d | D | T | T ₁ | D ₁ | d ₁ | R | r | H | E | C _{a0} | C _{a90} | |
| | mm in. | mm in. | mm in. | mm in. | mm in. | mm in. | mm in. | mm in. | mm in. | mm in. | kN lbf. | kN lbf. | kg lbs. |
| I-2290-C | 279.400 11.0000 | 603.250 23.7500 | 136.525 5.3750 | 25.40 1.000 | 601.68 23.688 | 282.58 11.125 | 6.1 0.24 | 6.1 0.24 | 549.3 21.63 | 321.5 12.66 | 35300 7940000 | 2530 570000 | 232.0 511.0 |
| T11500 | 292.100 11.5000 | 660.400 26.0000 | 127.000 5.0000 | 23.50 0.925 | 660.40 26.000 | 292.10 11.500 | 1.5 0.06 | 7.9 0.31 | 597.0 23.50 | 323.9 12.75 | 44000 9880000 | 2890 650000 | 235.2 518.4 |
| N-3311-A | 292.100 11.5000 | 660.400 26.0000 | 127.000 5.0000 | 19.29 0.759 | 673.10 26.500 | 295.28 11.625 | 9.5 0.38 | 9.5 0.38 | 644.8 25.38 | 334.4 13.17 | 45700 10300000 | 3030 682000 | 343.0 755.0 |
| G-3272-C | 304.775 11.9990 | 609.600 24.0000 | 114.046 4.4900 | 28.58 1.125 | 606.81 23.890 | 307.18 12.094 | 6.4 0.25 | 6.4 0.25 | 565.2 22.25 | 342.9 13.50 | 33100 7430000 | 2060 464000 | 180.0 396.6 |
| E-1994-C | 304.800 12.0000 | 673.100 26.5000 | 171.450 6.7500 | 37.31 1.469 | 671.51 26.438 | 307.98 12.125 | 7.6 0.30 | 7.6 0.30 | 609.3 23.99 | 333.1 13.11 | 41700 9370000 | 3060 687000 | 311.1 685.9 |
| F-3090-A | 304.800 12.0000 | 736.600 29.0000 | 279.400 11.0000 | 44.45 1.750 | 735.01 28.938 | 307.98 12.125 | 9.1 0.36 | 9.1 0.36 | 602.4 23.72 | 385.8 15.19 | 46400 10400000 | 4000 900000 | 629.2 1387.2 |
| I-2060-C | 368.541 14.5095 | 609.156 23.9825 | 120.269 4.7350 | 25.40 1.000 | 604.84 23.812 | 371.48 14.625 | 11.2 0.44 | 11.2 0.44 | 565.2 22.25 | 401.6 15.81 | 22400 5040000 | 1640 369000 | 160.6 354.0 |
| T15500 | 393.700 15.5000 | 495.300 19.5000 | 44.450 1.7500 | 11.15 0.439 | 495.30 19.500 | 393.70 15.500 | 3.3 0.13 | 3.3 0.13 | 471.6 18.57 | 408.3 16.07 | 6900 1550000 | 370 83700 | 20.2 44.5 |
| T15501 | 393.700 15.5000 | 495.300 19.5000 | 44.450 1.7500 | 11.15 0.439 | 495.30 19.500 | 393.70 15.500 | 3.3 0.13 | 3.3 0.13 | 471.6 18.57 | 408.3 16.07 | 6900 1550000 | 370 83700 | 18.1 40.0 |
| F-3131-G | 431.800 17.0000 | 863.600 34.0000 | 228.600 9.0000 | 44.45 1.750 | 862.01 33.938 | 434.98 17.125 | 10.2 0.40 | 10.2 0.40 | 783.3 30.84 | 489 19.25 | 66800 15000000 | 4790 1080000 | 659.0 1452.8 |
| E-2054-G | 440.000 17.3219 | 863.600 34.0000 | 228.600 9.0000 | 44.45 1.750 | 862.03 33.938 | 441.20 17.370 | 10.2 0.40 | 10.2 0.40 | 787.4 31.00 | 489.0 19.25 | 66800 15000000 | 4790 1080000 | 763.0 1681.0 |
| F-2342-A | 457.200 18.0000 | 762.000 30.0000 | 139.700 5.5000 | 25.40 1.000 | 760.43 29.938 | 460.38 18.125 | 5.1 0.20 | 5.1 0.20 | 713.6 28.09 | 508.0 20.00 | 43300 9740000 | 2870 645000 | 262.0 578.0 |
| T18500 | 469.900 18.5000 | 917.575 36.1250 | 222.250 8.7500 | 44.45 1.750 | 917.58 36.125 | 469.90 18.500 | 12.7 0.50 | 12.7 0.50 | 825.7 32.51 | 519.6 20.46 | 68200 15300000 | 4830 1090000 | 508.1 1120.1 |
| A-6096-C | 508.000 20.0000 | 990.600 39.0000 | 196.850 7.7500 | 67.47 2.656 | 990.60 39.000 | 508.58 20.062 | 12.7 0.50 | 12.7 0.50 | 927.1 36.50 | 563.6 22.19 | 77800 17500000 | 4420 994000 | 882.50 1946.00 |
| G-3734-A | 508.000 20.0000 | 990.600 39.0000 | 196.850 7.7500 | 67.47 2.656 | 990.60 39.000 | 509.58 20.062 | 15.1 0.59 | 15.1 0.59 | 927.1 36.50 | 563.6 22.19 | 77800 17500000 | 4420 994000 | 857.0 1890.0 |
| T20750 | 527.050 20.7500 | 635.000 25.0000 | 44.450 1.7500 | 12.70 0.500 | 635.00 25.000 | 527.05 20.750 | 3.3 0.13 | 3.3 0.13 | 611.0 24.05 | 544.4 21.43 | 7750 1740000 | 360 80200 | 28.6 63.0 |
| F-3093-A | 558.800 22.0000 | 1066.800 42.0000 | 285.370 11.2350 | 57.15 2.250 | 1065.21 41.938 | 561.98 22.125 | 10.2 0.40 | 10.2 0.40 | 952.5 37.50 | 639.8 25.19 | 89200 20100000 | 6550 1470000 | 1335.0 2943.1 |

⁽¹⁾Maximum shaft or housing fillet radius that bearing corners will clear.

⁽²⁾Bearing includes special features; contact your Timken engineer for details.

Continued on next page.

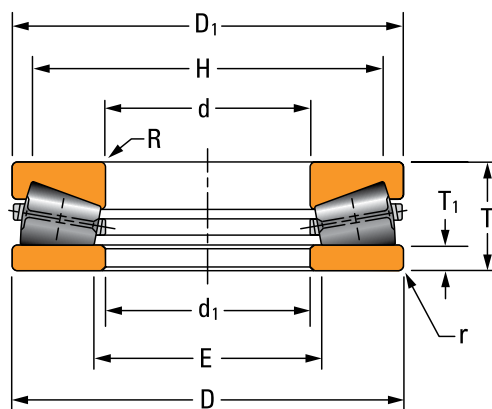

Continued from previous page.

| Bearing Number | Bearing Dimensions | | | Rings | | | Fillet Radius ⁽¹⁾ | | Shoulder Diameter | | Load Rating | | Bearing Weight |
|-------------------------|---------------------|---------------------|-------------------|----------------|---------------------|-------------------|------------------------------|----------------|-------------------|-----------------|--------------------|---------------------|------------------|
| | Bore | O.D. | Width | Thickness | Small Diameter O.D. | Large Bore I.D. | Shaft (Max.) | Housing (Max.) | Shaft (Min.) | Housing (Max.) | Static Load Rating | Dynamic Load Rating | |
| | d | D | T | T ₁ | D ₁ | d ₁ | R | r | H | E | C _{a0} | C _{a90} | |
| | mm in. | mm in. | mm in. | mm in. | mm in. | mm in. | mm in. | mm in. | mm in. | mm in. | kN lbf. | kN lbf. | kg lbs. |
| E-2394-A ⁽²⁾ | 558.927 22.0050 | 762.000 30.0000 | 101.600 4.0000 | 27.79 1.094 | 762.00 30.000 | 559.05 22.010 | 6.4 0.25 | 3.0 0.12 | 736.6 29.00 | 587.5 23.13 | 22900 5150000 | 1310 293000 | 127.2 309.1 |
| J-940-A | 609.600 24.0000 | 812.800 32.0000 | 101.600 4.0000 | 27.79 1.094 | 812.80 32.000 | 609.60 24.000 | 6.4 0.25 | 6.4 0.25 | 778.5 30.65 | 639.3 25.17 | 26200 5890000 | 1420 319000 | 174.0 398.0 |
| F-3172-C | 711.200 28.0000 | 965.200 38.0000 | 127.000 5.0000 | 30.16 1.188 | 963.61 37.938 | 714.38 28.125 | 4.8 0.19 | 4.8 0.19 | 917.6 36.12 | 762 30.00 | 37300 8390000 | 2140 480000 | 354.20 781.00 |
| H-2054-G | 711.200 28.0000 | 990.600 39.0000 | 190.500 7.5000 | 44.45 1.750 | 989.01 38.938 | 712.79 28.062 | 10.2 0.40 | 10.2 0.40 | 932.0 36.69 | 738.7 29.08 | 50900 11400000 | 3420 770000 | 460.00 1013.5 |
| E-2172-A ⁽²⁾ | 749.300 29.5000 | 952.500 37.5000 | 127.000 5.0000 | 31.75 1.250 | 955.68 37.625 | 762.00 30.000 | 5.1 0.20 | 2.5 0.10 | 916.0 36.06 | 781.2 30.75 | 24800 5570000 | 1460 328000 | 285.0 629.0 |
| T30620 | 777.697 30.6180 | 889.000 35.0000 | 47.625 1.8750 | 14.26 0.562 | 889.00 35.000 | 777.70 30.618 | 3.3 0.13 | 3.3 0.13 | 863.2 33.99 | 796.6 31.36 | 11500 2580000 | 440 99300 | 44.7 98.6 |
| E-2267-A | 800.100 31.5000 | 1041.400 41.0000 | 139.700 5.5000 | 30.94 1.218 | 1041.40 41.000 | 800.10 31.500 | 6.0 0.24 | 4.0 0.16 | 999.4 39.35 | 849.8 33.46 | 40600 9120000 | 2440 548000 | 308.1 679.3 |
| E-2421-A | 850.900 33.5000 | 1130.300 44.5000 | 149.860 5.9000 | 33.32 1.312 | 1130.00 44.489 | 850.90 33.500 | 9.5 0.38 | 3.2 0.13 | 1063.6 41.88 | 890.6 35.06 | 48800 11000000 | 2890 650000 | 462.0 1018.0 |
| T34250 | 870.001 34.2520 | 980.001 38.5827 | 50.000 1.9685 | 14.22 0.560 | 980.00 38.583 | 870.00 34.252 | 3.3 0.13 | 3.3 0.13 | 950.7 37.43 | 898.4 35.37 | 12500 2820000 | 480 109000 | 52.7 116.3 |
| E-1987-C | 939.800 37.0000 | 1244.600 49.0000 | 152.400 6.0000 | 35.71 1.406 | 1244.60 49.000 | 942.34 37.100 | 1.5 0.06 | 1.5 0.06 | 1193.8 47.00 | 984.3 38.75 | 65200 14600000 | 3440 774000 | 544.3 1200.0 |
| S-4228-C | 970.700 38.2165 | 1249.950 49.2105 | 130.000 5.1881 | 30.96 1.219 | 1249.95 49.211 | 970.70 38.217 | 4.8 0.19 | 4.8 0.19 | 1206.5 47.50 | 1012.8 39.88 | 59400 13400000 | 2900 651000 | 499.0 1099.0 |
| T45750 | 1162.050 45.7500 | 1282.700 50.5000 | 52.388 2.0625 | 15.96 0.628 | 1282.70 50.500 | 1162.05 45.750 | 3.3 0.13 | 3.3 0.13 | 1256.2 49.45 | 1180.0 46.46 | 19000 4280000 | 620 139000 | 80.7 177.8 |
| T45751 | 1162.050 45.7500 | 1282.700 50.5000 | 57.099 2.2480 | 20.67 0.814 | 1282.70 50.500 | 1162.05 45.750 | 3.3 0.13 | 3.3 0.13 | 1256.2 49.45 | 1180.0 46.46 | 19000 4280000 | 620 139000 | 80.7 177.8 |
| T53250 | 1352.550 53.2500 | 1473.200 58.0000 | 52.375 2.0620 | 15.89 0.626 | 1473.20 58.000 | 1352.55 53.250 | 3.3 0.13 | 3.3 0.13 | 1444.7 56.88 | 1368.5 53.88 | 21100 4750000 | 650 146000 | 94.4 208.0 |

⁽¹⁾Maximum shaft or housing fillet radius that bearing corners will clear.

⁽²⁾Bearing includes special features; contact your Timken engineer for details.

TYPE TTHDFLSA

- Same basic roller and raceway design as the TTHDFL, except that the lower race is composed of two pieces whose faces are spherically ground to permit self-alignment under conditions of initial misalignment.
- TTHDFLSA bearings should not be used if dynamic misalignment (changing under load) is expected.

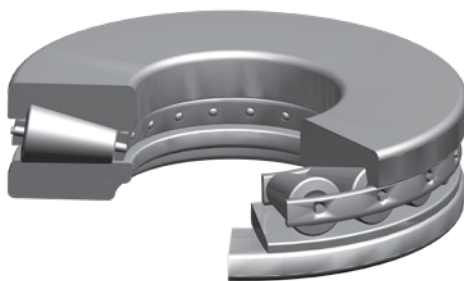
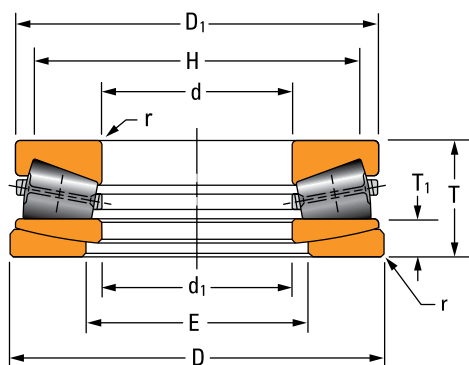

Fig. 75. Type TTHDFLSA thrust tapered roller bearing.



OVERALL DIMENSIONS:

- d – Bore diameter
- D – Bearing O.D.
- T – Bearing width
- T₁ – Ring thickness
- d₁ – Large bore I.D.
- D₁ – Small diameter O.D.
- E – Housing shoulder diameter
- H – Shaft shoulder diameter
- r – Shaft/housing maximum fillet radius

Fig. 76. Type TTHDFLSA thrust tapered roller bearing assembly.

THRUST BEARING DATA

THRUST TAPERED ROLLER BEARINGS – TYPE TTHDFLSA

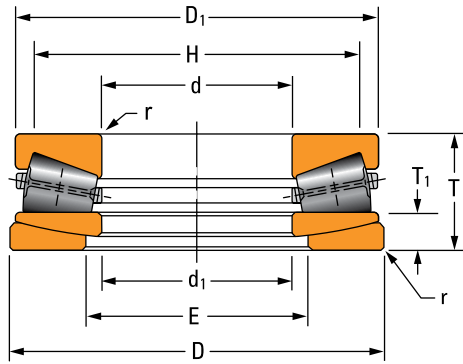

TABLE 46. THRUST TAPERED ROLLER BEARINGS – TYPE TTHDFLSA

| Bearing Number | Bearing Dimensions | | | Rings | | | Fillet ⁽¹⁾ Radius (Max.) r | Shoulder Diameter | | Load Rating | | Bearing Weight |
|----------------|--------------------|--------------------|--------------------|----------------|---------------------|------------------|--|-------------------|----------------|---------------------|----------------------|-----------------|
| | Bore | O.D. | Width | Thickness | Small Diameter O.D. | Large Bore I.D. | | Shaft (Min.) | Housing (Max.) | Static Load Ratings | Dynamic Load Ratings | |
| | d | D | T | T ₁ | D ₁ | d ₁ | | H | E | C _{a0} | C _{a90} | |
| | mm in. | mm in. | mm in. | mm in. | mm in. | mm in. | mm in. | mm in. | mm in. | kN lbf. | kN lbf. | kg lbs. |
| A-5934-B | 101.600 4.0000 | 203.200 8.0000 | 47.625 1.8750 | 15.37 0.605 | 203.20 8.000 | 101.60 4.000 | 1.5 0.06 | 182.6 7.19 | 119.1 4.69 | 2300 517000 | 200 44200 | (2) |
| C-7862-C | 127.000 5.0000 | 266.700 10.5000 | 71.425 2.8120 | 25.40 1.000 | 266.70 10.500 | 128.59 5.063 | 3.6 0.14 | 238.2 9.38 | 149.4 5.88 | 4920 1110000 | 400 91200 | 27.0 59.0 |
| B-7976-C | 184.150 7.2500 | 406.400 16.0000 | 203.200 8.0000 | 66.68 2.625 | 404.81 15.938 | 187.32 7.375 | 6.1 0.24 | 346.1 13.62 | 228.6 9.00 | 15000 3380000 | 1370 308000 | 157.4 347.0 |
| B-8824-C | 199.374 7.8730 | 399.948 15.7460 | 121.841 4.7969 | 36.40 1.433 | 396.88 15.625 | 203.20 8.000 | 4.1 0.16 | 358.8 14.12 | 240.5 9.47 | 13000 2920000 | 1060 237000 | 82.7 182.4 |
| S-3806-B | 199.975 7.8730 | 399.975 15.7470 | 121.881 4.7985 | 36.40 1.433 | 399.98 15.747 | 203.20 8.000 | 4 0.16 | 360.7 14.20 | 240.5 9.47 | 13000 2920000 | 1060 237000 | (2) |
| E-2004-C | 228.600 9.0000 | 482.549 18.9980 | 158.750 6.2500 | 44.91 1.768 | 479.55 18.880 | 231.78 9.125 | 4.8 0.19 | 419.1 16.50 | 282.6 11.12 | 20000 4500000 | 1670 375000 | 170.1 375.0 |
| H-2212-A | 228.600 9.0000 | 482.600 19.0000 | 158.750 6.2500 | 44.91 1.768 | 479.55 18.880 | 257.18 10.125 | 6.4 0.25 | 431.8 17.00 | 282.6 11.13 | 20000 4500000 | 1670 375000 | 142.2 313.5 |
| H-1685-C | 241.300 9.5000 | 488.899 19.2480 | 152.400 6.0000 | 57.15 2.250 | 482.60 19.000 | 242.09 9.531 | 6.1 0.24 | 431.8 17.00 | 279.4 11.00 | 18900 4240000 | 1460 329000 | 155.9 343.7 |
| P-1739-C | 304.800 12.0000 | 609.600 24.0000 | 215.900 8.5000 | 61.90 2.437 | 608.01 23.938 | 307.98 12.125 | 9.7 0.38 | 536.6 21.12 | 349.2 13.75 | 31100 6990000 | 2610 586000 | 305.6 673.8 |
| B-8750-G | 355.600 14.0000 | 660.400 26.0000 | 254.000 10.0000 | 76.20 3.000 | 657.23 25.875 | 358.78 14.125 | 10.2 0.4 | 577.9 22.75 | 412.8 16.25 | 34200 7700000 | 2900 652000 | (2) |
| B-8424-C | 406.400 16.0000 | 869.950 34.2500 | 241.300 9.5000 | 82.55 3.250 | 887.41 34.938 | 438.15 17.250 | 16.5 0.65 | 803.3 31.62 | 463.6 18.25 | 73500 16500000 | 4840 1090000 | 858.0 1892.0 |
| B-8073-C | 508.000 20.0000 | 990.600 39.0000 | 196.850 7.7500 | 67.31 2.650 | 989.03 38.938 | 511.18 20.125 | 12.7 0.5 | 927.1 36.50 | 563.6 22.19 | 77800 17500000 | 4420 994000 | (2) |

⁽¹⁾Maximum shaft or housing fillet radius that bearing corners will clear.

⁽²⁾Contact your Timken engineer for details.

TYPES TTSP, TTSPS AND TTSPSPL

- Comprised of two thrust tapered races, rollers, cage and an outside retainer which holds the components together during shipping and installation.
- Off-apex roller arrangement.
- These are light-duty thrust bearings which are used extensively in the steering pivot positions of automotive and other industrial applications.
- Types TTSP, TTSPS and TTSPSPL are identical except for the cage construction.

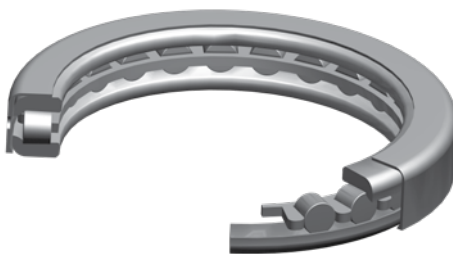
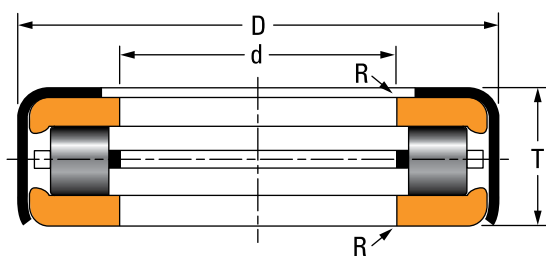

Fig. 77. Type TTSP thrust tapered roller bearing.



OVERALL DIMENSIONS:

- d – Bore diameter
- D – Bearing O.D.
- T – Bearing width
- R – Shaft maximum fillet radius

Fig. 78. Type TTSP thrust tapered roller bearing assembly.

DESIGN TYPES

TTSP

- Two tapered races.
- Stamped steel assembly retainer.
- Finger-type cage riding on small roller ends.

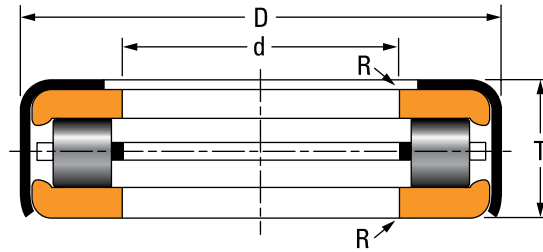

Fig. 79. Type TTSP.

TTSPS

- Two tapered races.
- Stamped steel assembly retainer.
- Finger-type cage riding on large roller ends.

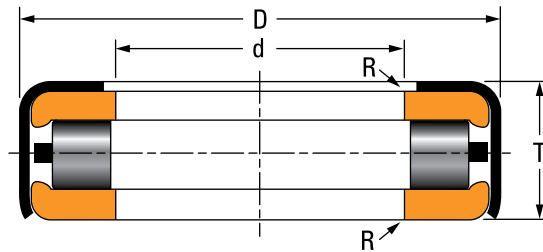

Fig. 80. Type TTSPS.

TTSPS

- Two tapered races.
- Stamped steel assembly retainer.
- Two-piece stamped steel cage.

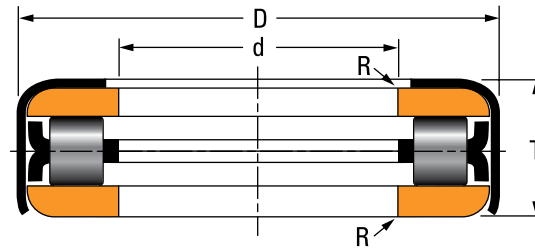

Fig. 81. Type TTSPS.

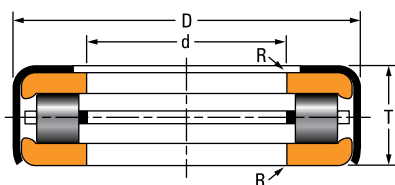

Fig. 1

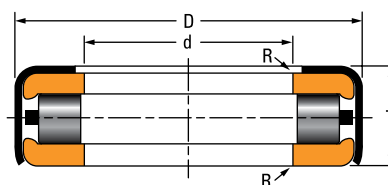

Fig. 2

TABLE 47. THRUST TAPERED ROLLER BEARINGS – TYPE TTSP

| Bearing Number | | Figure Number | Bearing Dimensions | | | Fillet ⁽¹⁾ Radius (Max.) R | Load Rating Steering Pivot Rating | Bearing Weight | Remarks |
|--------------------------|-----------------------|---------------|--------------------|------------------|------------------|---------------------------------------|-----------------------------------|----------------|---|
| No Oil Holes In Retainer | Oil Holes In Retainer | | Bore d | O.D. D | Width T | | | | |
| | | | mm in. | mm in. | mm in. | mm in. | N lbf. | kg lbs. | |
| T63 | T63W | 1 | 16.129 0.6350 | 41.275 1.6250 | 12.7 0.5000 | 0.8 0.03 | 11100 2500 | 0.1 0.2 | |
| T77 | T77W | 1 | 19.304 0.7600 | 41.275 1.6250 | 12.7 0.5000 | 0.8 0.03 | 11100 2500 | 0.1 0.2 | |
| T76 | T76W | 1 | 19.304 0.7600 | 41.275 1.6250 | 13.487 0.5310 | 0.8 0.03 | 11100 2500 | 0.1 0.2 | |
| T86 | | 1 | 20.257 0.7975 | 39.688 1.5625 | 14.288 0.5625 | 1.3 0.05 | 10700 2400 | 0.1 0.2 | |
| T82 | T82W | 1 | 20.879 0.8220 | 41.275 1.6250 | 13.487 0.5310 | 0.8 0.03 | 11100 2500 | 0.1 0.2 | |
| T88 | T88W | 1 | 22.479 0.8850 | 48.021 1.8906 | 15.088 0.5940 | 0.8 0.03 | 17300 3890 | 0.1 0.2 | |
| T89 | | 1 | 22.479 0.8850 | 48.021 1.8906 | 15.875 0.6250 | 0.8 0.03 | 17350 3900 | 0.1 0.3 | |
| T92 | | 2 | 23.825 0.9380 | 44.958 1.7700 | 13.487 0.5310 | 0.8 0.03 | 11950 2690 | (2) | T92 has two bores, other bore = 24.054 mm (0.9470 in.) |
| T93 | | 2 | 24.054 0.9470 | 44.958 1.7700 | 13.487 0.5310 | 0.8 0.03 | 11950 2690 | 0.1 0.2 | |
| T94 | T94W | 1 | 24.054 0.9470 | 48.021 1.8906 | 15.088 0.5940 | 0.8 0.03 | 17350 3900 | 0.1 0.2 | |
| T95 | T95W | 1 | 24.13 0.9500 | 50.8 2.0000 | 15.875 0.6250 | 0.8 0.03 | 18600 4200 | 0.1 0.3 | |
| T101 | T101W | 1 | 25.654 1.0100 | 50.8 2.0000 | 15.875 0.6250 | 0.8 0.03 | 18600 4200 | 0.1 0.3 | |
| T105 | | 1 | 25.654 1.0100 | 50.8 2.0000 | 15.875 0.6250 | 0.8 0.03 | 18600 4200 | (2) | T105 has 2 bores, other bore = 27.299 mm (1.0720 in.) |
| T102–T102R | | 1 | 25.654 1.0100 | 50.8 2.0000 | 16.916 0.6660 | 0.8 0.03 | 18600 4200 | (2) | T102 has extended retainer Contact Timken engineer for details |
| T114 | T114W | 1 | 25.654 1.0100 | 55.562 2.1875 | 15.875 0.6250 | 0.8 0.03 | 20000 4500 | (2) | T114 and T114W have two bores, other bore = 28.829 mm (1.1350 in.) |
| T104 | T104W | 1 | 26.289 1.0350 | 50.8 2.0000 | 15.875 0.6250 | 0.8 0.03 | 18600 4200 | 0.1 0.3 | |
| T107 | | 1 | 27.299 1.0720 | 50.8 2.0000 | 15.875 0.6250 | 0.8 0.03 | 18600 4200 | 0.1 0.3 | |
| T114X | | 2 | 28.829 1.1350 | 50.8 2.0000 | 15.875 0.6250 | 0.8 0.03 | 20000 4500 | (2) | T114X has two cages and two bores, other bore = 29.261 mm (1.1520 in.) |

⁽¹⁾Maximum shaft or housing fillet radius that bearing corners will clear.

⁽²⁾Contact your Timken engineer for details.

Continued on next page.

THRUST BEARING DATA

THRUST TAPERED ROLLER BEARINGS – TYPES TTSP, TTSPS AND TTSP L

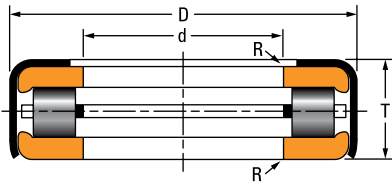

Fig. 1

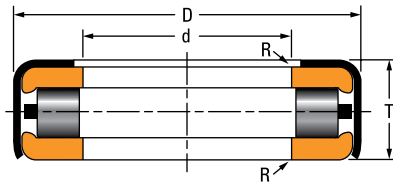

Fig. 2

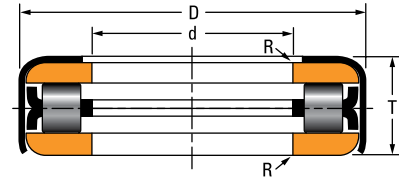

Fig. 3

TABLE 47. THRUST TAPERED ROLLER BEARINGS – TYPE TTSP – continued

| Bearing Number | | Figure Number | Bearing Dimensions | | | Fillet ⁽¹⁾ Radius (Max.) R | Load Rating | | Bearing Weight | Remarks |
|--------------------------|-----------------------|---------------|--------------------|-------------------|------------------|---------------------------------------|-----------------------|------------|-------------------|---------|
| No Oil Holes In Retainer | Oil Holes In Retainer | | Bore d | O.D. D | Width T | | Steering Pivot Rating | | | |
| | | | mm in. | mm in. | mm in. | mm in. | N lbf. | kg lbs. | | |
| T110 | T110W | 1 | 28.829 1.1350 | 53.188 2.0940 | 15.875 0.6250 | 0.8 0.03 | 20000 4500 | 0.1 0.3 | | |
| T113 | T113W | 1 | 28.829 1.1350 | 55.562 2.1875 | 15.875 0.6250 | 0.8 0.03 | 20000 4500 | 0.2 0.3 | | |
| T113X | | 1 | 28.829 1.1350 | 55.562 2.1875 | 15.875 0.6250 | 0.8 0.03 | 20000 4500 | 0.2 0.4 | | |
| T120 | | 2 | 30.416 1.1975 | 54.745 2.1553 | 11.43 0.4500 | 0.8 0.03 | 16500 3710 | 0.1 0.2 | | |
| T119 | T119W | 1 | 30.416 1.1975 | 55.562 2.1875 | 15.875 0.6250 | 0.8 0.03 | 20000 4500 | 0.2 0.3 | | |
| T121 | | 1 | 30.716 1.2093 | 55.562 2.1875 | 15.875 0.6250 | 0.8 0.03 | 20000 4500 | 0.2 0.4 | | |
| T126 | T126W | 1 | 32.004 1.2600 | 55.562 2.1875 | 15.875 0.6250 | 0.8 0.03 | 20000 4500 | 0.1 0.3 | | |
| T126A | T126AW | 1 | 32.004 1.2600 | 55.562 2.1875 | 15.875 0.6250 | 0.8 0.03 | 20000 4500 | 0.1 0.3 | T126A – two cages | |
| T1370 | | 1 | 35.02 1.3787 | 55.562 2.1875 | 15.875 0.6250 | 0.8 0.3 | 16000 3600 | 0.1 0.3 | | |
| T139 | T139W | 1 | 35.179 1.3850 | 58.738 2.3125 | 15.875 0.6250 | 0.8 0.03 | 21400 4800 | 0.2 0.3 | | |
| T142 | T142W | 1 | 35.179 1.3850 | 62.708 2.4688 | 19.431 0.7650 | 0.8 0.03 | 22400 5050 | 0.2 0.5 | | |
| T149 | T149W | 1 | 38.303 1.5080 | 65.883 2.5938 | 19.431 0.7650 | 0.8 0.03 | 23600 5300 | 0.2 0.5 | | |
| T158 | | 1 | 40.234 1.5840 | 65.883 2.5938 | 19.431 0.7650 | 0.8 0.03 | 23600 5300 | 0.2 0.5 | | |
| T1760 | | 3 | 44.623 1.7568 | 76.2 3.0000 | 10.922 0.4300 | 0.8 0.03 | 31600 7100 | 0.2 0.4 | | |
| T199 | T199W | 1 | 51.054 2.0100 | 74.612 2.9375 | 15.875 0.6250 | 0.8 0.03 | 26000 5850 | 0.2 0.4 | | |
| T309 | | 1 | 78.583 3.0938 | 102.395 4.0313 | 15.875 0.6250 | 0.8 0.03 | 35400 8000 | 0.3 0.6 | | |
| T387 | T387W | 1 | 96.425 3.8750 | 127 5.0000 | 17.463 0.7650 | 0.8 0.03 | 43000 9700 | 0.5 1.1 | | |
| T484 | | 1 | 123.012 4.8430 | 152.4 6.0000 | 17.463 0.6875 | 0.8 0.03 | 47500 10600 | 0.6 1.4 | | |
| T581 | | 1 | 147.638 5.8125 | 177.8 7.0000 | 17.463 0.6875 | 0.8 0.03 | 51500 11600 | 0.9 2.0 | | |

⁽¹⁾Maximum shaft or housing fillet radius that bearing corners will clear.

⁽²⁾Contact your Timken engineer for details.

TYPES TTC, TTCS AND TTCL

- Comprised of two thrust tapered races, rollers and an outside retainer which holds the components together during shipping and installation.
- Full complement design (cageless).
- These thrust bearings are specifically designed for oscillating applications.
- Types TTC, TTCS and TTCL are identical except for the outside retainer construction.



Fig. 82. Type TTC thrust tapered roller bearing.

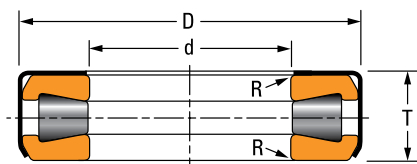

Fig. 83. Type TTC thrust tapered roller bearing assembly.

OVERALL DIMENSIONS:

- d – Bore diameter
- D – Bearing O.D.
- T – Bearing width
- R – Shaft maximum fillet radius

DESIGN TYPES

TTC

- Two tapered races.
- Full complement of rollers, no cage.
- Stamped-steel assembly retainer that fully wraps around one race.

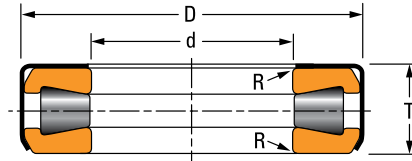

Fig. 84. Type TTC.

TTCS

- Two tapered races.
- Full complement of rollers, no cage.
- Stamped steel assembly retainer pressed onto the O.D. faces.

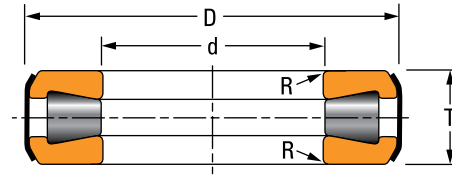

Fig. 85. Type TTCS.

TTCL

- Two tapered races.
- Full complement of rollers, no cage.
- Two-piece stamped steel retainer with O.D. seal.

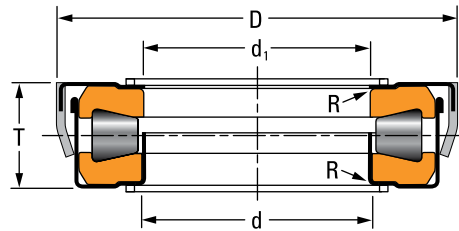

Fig. 86. Type TTCL.

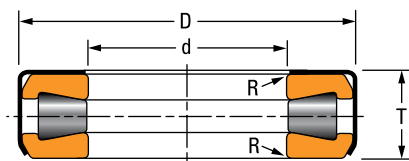

Fig. 1

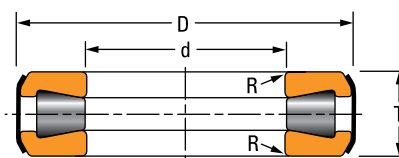

Fig. 2

TABLE 48. THRUST TAPERED ROLLER BEARINGS – TYPE TTC, TTCS AND TTCL

| Bearing Number | | Figure Number | Bearing Dimensions | | | Fillet ⁽¹⁾ Radius (Max.) R | Load Rating Steering Pivot Rating | Bearing Weight | Remarks |
|--------------------------|-----------------------|---------------------|--------------------|------------------|------------------|---------------------------------------|-----------------------------------|----------------|--|
| No Oil Holes In Retainer | Oil Holes In Retainer | | Bore d | O.D. D | Width T | | | | |
| mm in. | mm in. | | mm in. | mm in. | mm in. | N lbf. | kg lbs. | | |
| T130 | | 1 | 27.102 1.0670 | 66.675 2.6250 | 19.446 0.7656 | 0.8 0.03 | 42200 9450 | 0.3 0.8 | |
| T1260 | T1260W | 1 | 32.004 1.2600 | 55.562 2.1875 | 15.875 0.6250 | 0.8 0.03 | 27600 6200 | 0.2 0.4 | |
| T128 | | 2 | 32.004 1.2600 | 66.675 2.6250 | 18.654 0.7344 | 0.8 0.03 | 42200 9450 | 0.3 0.6 | |
| T127 | T127W | 1 | 32.004 1.2600 | 66.675 2.6250 | 19.446 0.7656 | 0.8 0.03 | 42200 9450 | 0.3 0.7 | |
| T1380 | | SPCL ⁽²⁾ | 35.179 1.3850 | 59.400 2.3386 | 15.875 0.6250 | 0.8 0.03 | 31200 7000 | 0.4 0.8 | Two-piece seal. |
| T136 | | 2 | 35.179 1.3850 | 66.675 2.6250 | 18.654 0.7344 | 0.8 0.03 | 42200 9450 | 0.3 0.6 | |
| T138 | T138W | 1 | 35.179 1.3850 | 66.675 2.6250 | 19.446 0.7656 | 0.8 0.03 | 42200 9450 | 0.3 0.7 | |
| T138XS | | SPCL ⁽²⁾ | 35.179 1.3850 | 66.675 2.6250 | 19.446 0.7656 | 0.8 0.03 | 42200 9450 | 0.3 0.7 | T138XS has two bores, other bore = 35.387 mm (1.3972 in.). |
| T1381 | | 2 | 35.180 1.3850 | 59.475 2.3415 | 15.875 0.6250 | 0.8 0.03 | 31200 7000 | 0.3 0.7 | |
| T144 | T144W | 1 | 36.754 1.4470 | 66.675 2.6250 | 19.446 0.7656 | 1.5 0.06 | 42200 9450 | 0.3 0.6 | |
| T144XA | | SPCL ⁽²⁾ | 36.754 1.4470 | 66.675 2.6250 | 19.446 0.7656 | 1.5 0.06 | 42200 9450 | 0.3 0.6 | T144XA has two bores, other bore = 37.137 mm (1.4621 in.). |
| T152 | | 2 | 38.354 1.5100 | 72.619 2.8590 | 20.638 0.8125 | 0.8 0.03 | 47000 10600 | 0.4 0.8 | |
| T151 | T151W | 1 | 38.354 1.5100 | 72.619 2.8590 | 21.433 0.8438 | 0.8 0.03 | 47000 10600 | 0.4 0.8 | |
| T157 | T157W | 1 | 39.954 1.5730 | 72.619 2.8590 | 21.433 0.8438 | 0.8 0.03 | 47000 10600 | 0.4 0.8 | |
| T178 | | 1 | 40.401 1.5906 | 73.000 2.8740 | 19.000 0.7480 | 0.8 0.03 | 47500 10700 | 0.3 0.7 | |
| T163 | T163W | 1 | 41.529 1.6350 | 72.619 2.8590 | 21.433 0.8438 | 0.8 0.03 | 47000 10600 | 0.4 0.8 | |
| T163X | T163XW | 1 | 41.529 1.6350 | 72.619 2.8590 | 21.433 0.8438 | 2 0.80 | 47000 10600 | 0.4 0.8 | |
| T169 | T169W | 1 | 43.104 1.6970 | 82.956 3.2660 | 23.812 0.9375 | 0.8 0.03 | 64000 14300 | 0.6 1.2 | |

⁽¹⁾Maximum shaft fillet radius that bearing corners will clear.

⁽²⁾SPCL = special not shown.

Continued on next page.

THRUST BEARING DATA

THRUST TAPERED ROLLER BEARINGS – TYPES TTC, TTCS AND TTCL

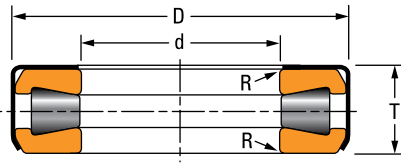

Fig. 1

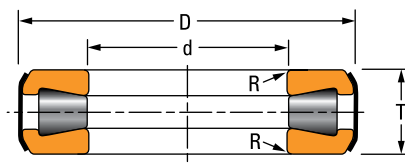

Fig. 2

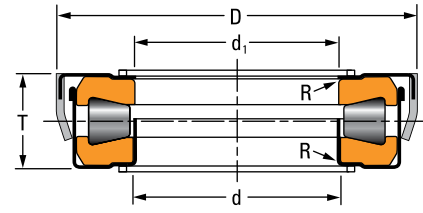

Fig. 3

TABLE 48. THRUST TAPERED ROLLER BEARINGS – TYPE TTC, TTCS AND TTCL – continued

| Bearing Number | | Figure Number | Bearing Dimensions | | | Fillet ⁽¹⁾ Radius (Max.) R | Load Rating Steering Pivot Rating | Bearing Weight | Remarks |
|--------------------------|-----------------------|---------------------|--------------------|------------------|------------------|---------------------------------------|-----------------------------------|----------------|--|
| No Oil Holes In Retainer | Oil Holes In Retainer | | Bore d | O.D. D | Width T | | | | |
| mm in. | mm in. | | mm in. | mm in. | mm in. | N lbf. | kg lbs. | | |
| T176 | T176W | 1 | 44.704 1.7600 | 82.956 3.2660 | 23.812 0.9375 | 0.8 0.03 | 64000 14300 | 0.5 1.2 | |
| T177 | | 1 | 45.000 1.7717 | 73.000 2.8740 | 20.000 0.7874 | 0.8 0.03 | 47500 10700 | 0.3 0.7 | |
| T177XA | | SPCL ⁽²⁾ | 45.000 1.7717 | 73.127 2.8790 | 20.000 0.7874 | 0.8 0.03 | 47500 10700 | 0.3 0.7 | T177XA has two bores, other bore = 45.484 mm (1.7907 in.). |
| T177S | | 3 | 45.000 1.7717 | 74.500 2.9331 | 20.221 0.7961 | 0.8 0.03 | 47500 10700 | 0.4 0.8 | |
| T177A | | 1 | 45.484 1.7907 | 73.000 2.8740 | 20.000 0.7874 | 0.8 0.03 | 47500 10700 | 0.3 0.7 | |
| T1921 | | 1 | 46.279 1.8220 | 80.010 3.1500 | 15.977 0.6290 | 0.8 0.03 | 56500 12700 | 0.3 0.8 | |
| T182 | T182W | 1 | 46.279 1.8220 | 82.956 3.2660 | 23.812 0.9375 | 0.8 0.03 | 64000 14300 | 0.5 1.2 | |
| T189 | T189W | 2 | 47.879 1.8850 | 82.956 3.2660 | 23.020 0.9063 | 0.8 0.03 | 64000 14300 | 0.5 1.1 | |
| T188 | T188W | 1 | 47.879 1.8850 | 82.956 3.2660 | 23.812 0.9375 | 0.8 0.03 | 64000 14300 | 0.5 1.2 | |
| T190 | | 2 | 47.879 1.8850 | 83.083 3.2710 | 23.020 0.9063 | 0.8 0.03 | 64000 14300 | 0.5 1.2 | |
| T1910 | | 3 | 49.000 1.9290 | 85.471 3.3650 | 16.383 0.6450 | 0.8 0.03 | 56500 12700 | 0.3 0.7 | |
| T1920 | | 3 | 49.000 1.9290 | 85.471 3.3650 | 16.383 0.6450 | 0.8 0.03 | 56500 12700 | 0.4 0.8 | |
| T1930 | | 3 | 49.000 1.9290 | 85.471 3.3650 | 16.383 0.6450 | 0.8 0.03 | 56500 12700 | 0.3 0.6 | |
| T193 | T193W | 2 | 49.454 1.9470 | 93.269 3.6720 | 26.187 1.0310 | 0.8 0.03 | 86000 19400 | 0.8 1.8 | |
| T194 | T194W | 1 | 49.454 1.9470 | 93.269 3.6720 | 26.975 1.0620 | 0.8 0.03 | 86000 19400 | 0.8 1.8 | |
| T195 | | 2 | 49.467 1.9475 | 93.396 3.6770 | 26.213 1.0320 | 0.8 0.03 | 86000 19400 | 0.9 1.9 | |
| T201 | T201W | 2 | 51.054 2.0100 | 93.269 3.6720 | 26.187 1.0310 | 3.3 0.13 | 86000 19400 | 0.8 1.7 | |
| T202 | T202W | 1 | 51.054 2.0100 | 93.269 3.6720 | 26.975 1.0620 | 3.3 0.13 | 86000 19400 | 0.8 1.8 | |
| T209 | T209W | 2 | 52.629 2.0720 | 93.269 3.6720 | 26.187 1.0310 | 0.8 0.03 | 86000 19400 | 0.8 1.7 | |

⁽¹⁾Maximum shaft fillet radius that bearing corners will clear.

⁽²⁾SPCL = special not shown.

Continued on next page.

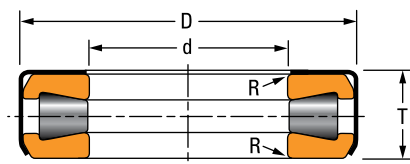

Fig. 1

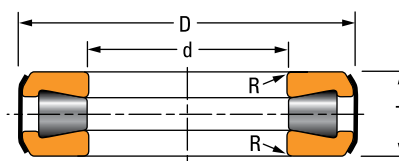

Fig. 2

Continued from previous page.

| Bearing Number | | Figure Number | Bearing Dimensions | | | Fillet ⁽¹⁾ Radius (Max.) R | Load Rating | | Remarks |
|--------------------------|-----------------------|---------------|--------------------|-------------------|------------------|---------------------------------------|-----------------------|----------------|---------|
| No Oil Holes In Retainer | Oil Holes In Retainer | | Bore d | O.D. D | Width T | | Steering Pivot Rating | Bearing Weight | |
| mm in. | mm in. | | mm in. | mm in. | mm in. | N lbf. | kg lbs. | | |
| T208 | T208W | 1 | 52.629 2.0720 | 93.269 3.6720 | 26.975 1.0620 | 0.8 0.03 | 86000 19400 | 0.8 1.7 | |
| T252 | T252W | 2 | 63.754 2.5100 | 111.125 4.3750 | 25.796 1.0156 | 0.8 0.03 | 124000 27900 | 1.1 2.2 | |
| T251 | T251W | 1 | 63.754 2.5100 | 111.125 4.3750 | 26.988 1.0625 | 0.8 0.03 | 124000 27900 | 1.1 2.4 | |
| T301 | T301W | 2 | 76.454 3.0100 | 133.350 5.2500 | 33.338 1.3125 | 2.3 0.09 | 178500 40000 | 1.9 4.1 | |
| T302 | T302W | 1 | 76.454 3.0100 | 133.350 5.2500 | 34.925 1.3750 | 2.3 0.09 | 178500 40000 | 2.0 4.4 | |
| T350 | | 2 | 88.900 3.5000 | 133.350 5.2500 | 33.335 1.3124 | 2.8 0.11 | 115500 26000 | 1.4 3.1 | |
| T4020 | | 2 | 102.108 4.0200 | 179.619 7.0716 | 31.750 1.2500 | 1.5 0.06 | 324000 73000 | 3.7 8.2 | |
| T402 | T402W | 2 | 102.108 4.0200 | 179.619 7.0716 | 44.450 1.7500 | 1.5 0.06 | 344000 77500 | 4.8 10.7 | |
| T600 | T600W | 1 | 152.400 8.0000 | 241.300 9.5000 | 76.200 3.0000 | 3.3 0.13 | 575000 129000 | 14.1 31.1 | |

⁽¹⁾Maximum shaft fillet radius that bearing corners will clear.

⁽²⁾SPCL = special not shown.

SCREWDOWN BEARINGS – TYPES TTHDSX/SV AND TTHDFLSX/SV

- Designed specifically for rolling mill screw-down systems in the metals industry.
- Full complement (cageless) designs.
- Design variants include bearings with either a convex or concave profile tapered race.

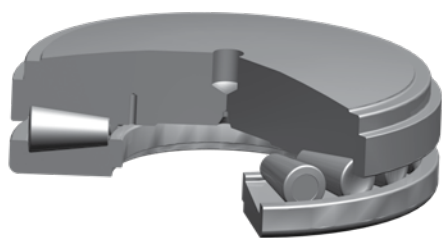

Fig. 87. Type TTHDSX.

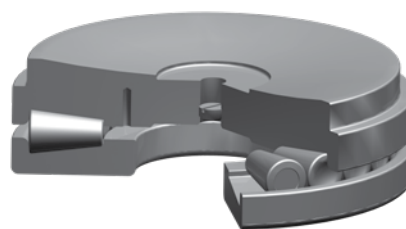

Fig. 88. Type TTHDSV.

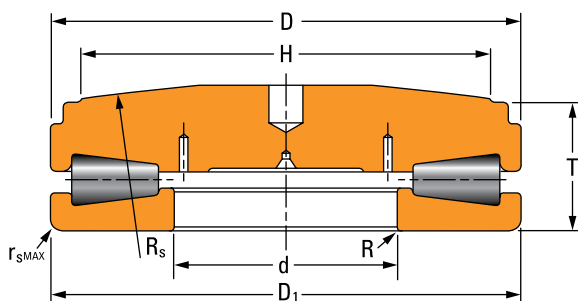

Fig. 89. Type TTHDSX thrust tapered roller bearing assembly.

OVERALL DIMENSIONS:

- d – Bore diameter (applies to TTHDSX and TTHDSV)
- D – Large O.D.
- D₁ – Small O.D.
- T – Bearing width
- H – Screw extension diameter
- R_s – Spherical radius
- R – Shaft maximum fillet radius
- r_{s max} – Housing maximum fillet radius

DESIGN TYPES

TTHDFLSX-1

- One lower flat race.
- One upper tapered race with a special convex profile.

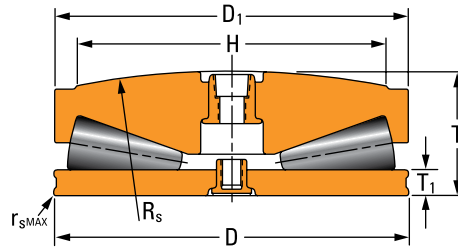

Fig. 90. Type TTHDFLSX-1.

TTHDFLSX-2

- One lower flat race.
- One upper tapered race with a special convex profile.
- Cage.

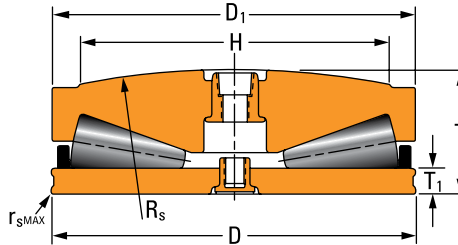

Fig. 91. Type TTHDFLSX-2.

TTHDFLSX-3

- Three-ring design.
- One lower flat race.
- One upper tapered race with a special convex profile.
- One top aligning plate.

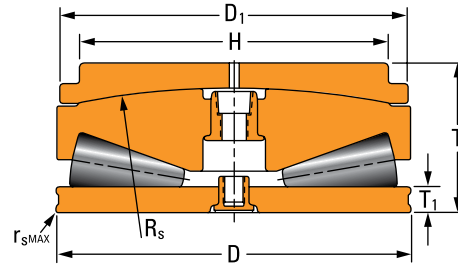

Fig. 92. Type TTHDFLSX-3.

TTHDSX-1

- One lower tapered race with axial bore.
- One upper tapered race with a special convex profile.

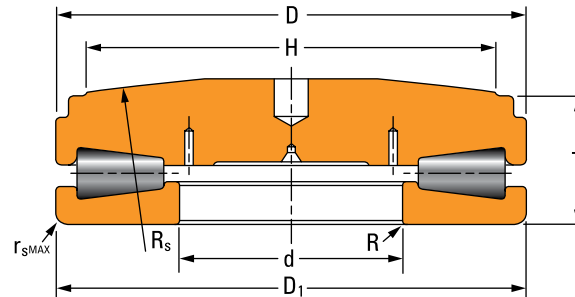

Fig. 93. Type TTHDSX-1.

TTHDSX-2

- One lower tapered race with axial bore and recess diameter.
- One upper tapered race with a special convex profile.

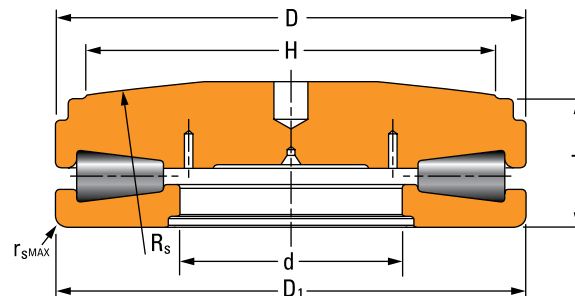

Fig. 94. Type TTHDSX-2.

TTHDFLSV-1

- One lower flat race.
- One upper tapered race with a special concave profile.

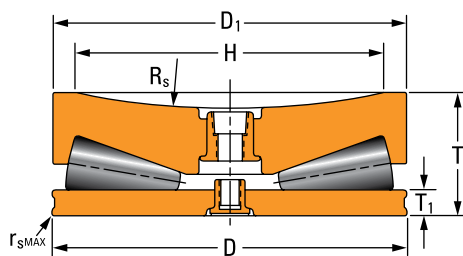

Fig. 95. Type TTHDFLSV-1.

TTHDFLSV-2

- Three-ring design.
- One lower flat race with a special convex profile.
- One upper tapered race.
- One bottom aligning plate.

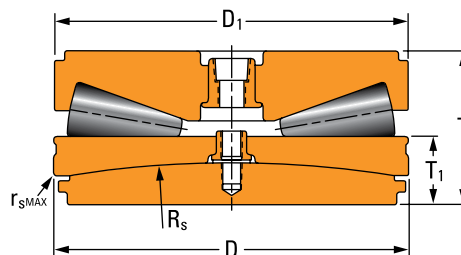

Fig. 96. Type TTHDFLSV-2.

TTHDSV-1

- One lower tapered race with axial bore.
- One upper tapered race with a special concave profile.

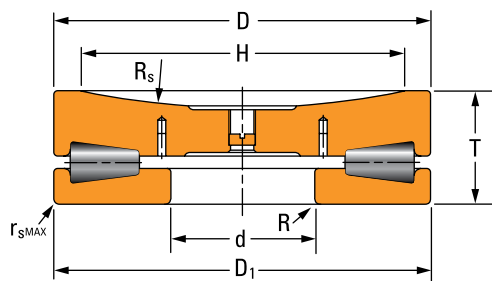

Fig. 97. Type TTHDSV-1.

TTHDSV-2

- One lower tapered race with axial bore and recess diameter.
- One upper tapered race with a special concave profile.

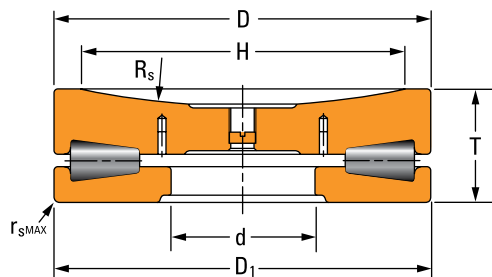

Fig. 98. Type TTHDSV-2.

TTHDDV

- One lower flat race.
- One upper tapered race.

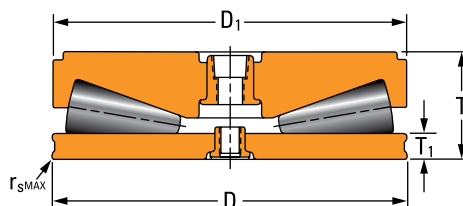

Fig. 99. Type TTHDDV.

THRUST BEARING DATA

THRUST TAPERED ROLLER BEARINGS – SCREWDOWN BEARINGS – TYPES TTHDSX/SV AND TTHDFLSX/SV

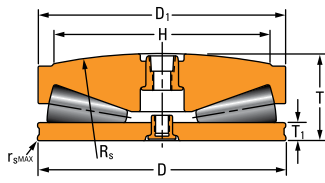

Fig. 1

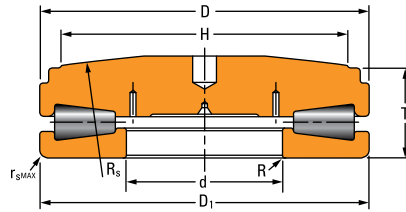

Fig. 3

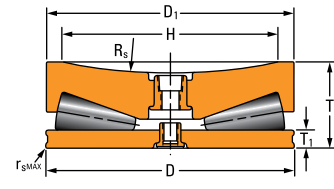

Fig. 7

TABLE 49. SCREWDOWN BEARINGS – TYPES TTHDSX/SV AND TTHDFLSX/SV

| Bearing Part Number | Figure No. | Bearing Dimensions | | | | | | Static Load Rating C_{a0} | Mounting Dimensions | | | Bearing Weight kg lbs. | Tolerance Table |
|---------------------|------------|--------------------|--------------------|------------------|------------------|-------------------|--------------------------|--------------------------------|---------------------|--------------------|-------------|------------------------------|-----------------|
| | | Large O.D. | Small O.D. | Bearing Width | Flat Race Width | Bore | Screw Extension Diameter | | Spherical Radius | | | | |
| | | D | D ₁ | T | T ₁ | d | H | | R _s | r _{s max} | R | | |
| | | mm in. | mm in. | mm in. | mm in. | mm in. | mm in. | mm in. | mm in. | mm in. | kg lbs. | | |
| B-7461-B | 1 | 123.825 4.8750 | 120.650 4.7500 | 43.332 1.7060 | 38.100 1.5000 | – | 101.600 4.0000 | 1500 337000 | 457.2 18.00 | 1.5 0.06 | – | (1) | 10, 11 |
| 58 TTSV 908 | 7 | 149.225 5.8750 | 146.863 5.7820 | 47.625 1.8750 | 12.700 0.5000 | – | 127.000 5.0000 | 2520 566000 | 228.6 9.00 | 1.5 0.06 | – | (1) | 10, 11 |
| T311-T311S | 3 | 161.925 6.3750 | 161.925 6.3750 | 49.213 1.9375 | – | 76.200 3.0000 | 127.000 5.0000 | 2330 524000 | 457.2 18.00 | 3.3 0.13 | 3.3 0.13 | 6.6 14.5 | 9, 10, 11 |
| 68 TTSV 910 | 7 | 174.625 6.8750 | 172.263 6.7820 | 52.375 2.0620 | 12.700 0.5000 | – | 152.400 6.0000 | 3180 716000 | 228.6 9.00 | 1.6 0.06 | – | (1) | 10, 11 |
| 68 TTSX 910 | 1 | 174.625 6.8750 | 172.263 6.7820 | 61.392 2.4170 | 12.700 0.5000 | – | 152.400 6.0000 | 3180 716000 | 457.2 18.00 | 1.5 0.06 | – | (1) | 10, 11 |
| 80 TTSX 914 | 1 | 203.200 8.0000 | 200.838 7.9070 | 75.616 2.9770 | 15.875 0.6250 | – | 177.800 7.0000 | 4630 1040000 | 508.0 20.00 | 1.6 0.06 | – | 17.7 38.9 | 10, 11 |
| 80 TTSX 914 OA076 | 1 | 203.200 8.0000 | 200.838 7.9070 | 95.250 3.7500 | 15.875 0.6250 | – | 177.800 7.0000 | 4630 1040000 | 508.0 20.00 | 1.5 0.06 | – | (1) | 10, 11 |
| T411FAS-T411S | 3 | 215.900 8.5000 | 215.900 8.5000 | 65.088 2.5625 | – | 76.200 3.0000 | 171.450 6.7500 | 4020 904000 | 508.0 20.00 | 3.3 0.13 | 3.3 0.13 | 8.9 19.6 | 9, 10, 11 |
| 105 TTSV 918 | 7 | 266.700 10.5000 | 264.338 10.4070 | 80.963 3.1875 | 19.050 0.7500 | – | 228.600 9.0000 | 8230 1850000 | 304.8 12.00 | 1.5 0.06 | – | 32.6 71.8 | Spec. |
| 105 TTSV 918 OC1150 | 7 | 266.700 10.5000 | 264.338 10.4070 | 80.950 3.1870 | 19.050 0.7500 | – | 228.600 9.0000 | 8230 1850000 | 355.6 14.00 | 1.5 0.06 | – | 30.0 66.0 | 10, 11 |
| 105 TTSX 918 B0035 | 1 | 266.700 10.5000 | 264.338 10.4070 | 94.412 3.7170 | 19.050 0.7500 | – | 228.600 9.0000 | 8230 1850000 | 609.6 24.00 | 1.5 0.06 | – | 38.0 83.8 | 10, 11 |
| T511FSA-T511S | 3 | 266.700 10.5000 | 266.700 10.5000 | 79.375 3.1250 | – | 101.600 4.0000 | 215.900 8.5000 | 6050 1360000 | 609.6 24.00 | 4.8 0.19 | 4.8 0.19 | 17.8 39.2 | 9, 10, 11 |
| T511FS-T511SB | 3 | 266.700 10.5000 | 266.700 10.5000 | 79.375 3.1250 | – | 112.700 4.4370 | 215.900 8.5000 | 6050 1360000 | 609.6 24.00 | 4.8 0.19 | 4.8 0.19 | 17.8 39.2 | 9, 10, 11 |
| T611FSA-T611SA | 3 | 317.500 12.5000 | 317.500 12.5000 | 87.313 3.4375 | – | – | 228.600 9.0000 | 8810 1980000 | 762.0 30.00 | 6.4 0.25 | – | 29.3 64.6 | 9, 10, 11 |
| T611FS-T611SA | 3 | 317.500 12.5000 | 317.500 12.5000 | 87.313 3.4375 | – | 152.400 6.0000 | 228.600 9.0000 | 8810 1980000 | 762.0 30.00 | 6.4 0.25 | 6.4 0.25 | 29.3 64.6 | 9, 10, 11 |

⁽¹⁾Contact your Timken engineer.

NOTE: Spec. = Special tolerance structure, contact your Timken engineer.

Continued on next page.

THRUST TAPERED ROLLER BEARINGS – SCREWDOWN BEARINGS – TYPES TTHDSX/SV AND TTHDFLSX/SV

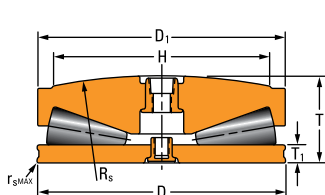

Fig. 1

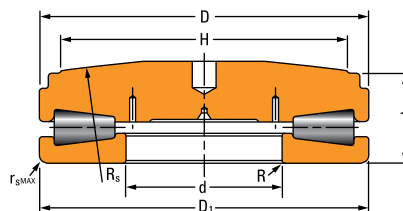

Fig. 3

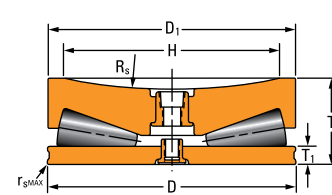

Fig. 7

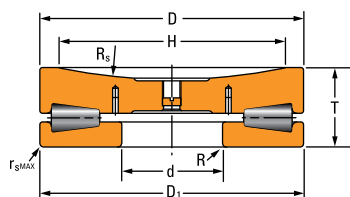

Fig. 8

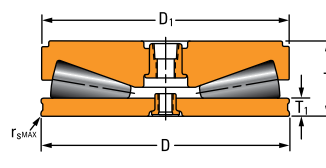

Fig. 10

Continued from previous page.

| Bearing Part Number | Figure No. | Bearing Dimensions | | | | | | Static Load Rating | Mounting Dimensions | | | Bearing Weight | Tolerance Table |
|---------------------|------------|--------------------|--------------------|-------------------|------------------|-------------------|--------------------------|--------------------|---------------------|-------------|-------------|----------------|-----------------|
| | | Large O.D. | Small O.D. | Bearing Width | Flat Race Width | Bore | Screw Extension Diameter | | Spherical Radius | $r_{s\max}$ | R | | |
| | | D | D ₁ | T | T ₁ | d | H | | R _s | | | | |
| mm in. | mm in. | mm in. | mm in. | mm in. | mm in. | mm in. | mm in. | mm in. | mm in. | kg lbs. | | | |
| 126 TTSV 922 | 7 | 320.675 12.6250 | 318.313 12.5320 | 95.250 3.7500 | 22.225 0.8750 | – | 279.400 11.0000 | 12540 2820000 | 381.0 15.00 | 1.6 0.06 | – | 55.4 122.2 | 10, 11 |
| 126 TTSV 922 OD617 | 7 | 320.675 12.6250 | 318.313 12.5320 | 127.000 5.0000 | 22.225 0.8750 | – | 228.600 9.0000 | 12540 2820000 | 533.4 21.00 | 1.5 0.06 | – | 55.4 122.2 | 10, 11 |
| 126 TTSX 922 C0740 | 1 | 320.675 12.6250 | 318.313 12.5320 | 110.973 4.3690 | 22.225 0.8750 | – | 279.400 11.0000 | 12540 2820000 | 762.0 30.00 | 1.5 0.06 | – | 64.6 142.3 | 10, 11 |
| 126 TTSX 922 OC076 | 1 | 320.675 12.6250 | 318.313 12.5320 | 126.187 4.9680 | 22.225 0.8750 | – | 279.400 11.0000 | 12540 2820000 | 762.0 30.00 | 1.5 0.06 | – | 64.6 142.3 | 10, 11 |
| 126 TTSX 922 E01984 | 1 | 329.938 12.9897 | 318.313 12.5320 | 110.973 4.3690 | 22.225 0.8750 | – | 279.400 11.0000 | 12540 2820000 | 762.0 30.00 | 1.8 0.07 | – | 64.0 140.0 | Spec. |
| T711FSS-T711SA | 8 | 368.300 14.5000 | 368.300 14.5000 | 104.775 4.1250 | – | – | 292.100 11.5000 | 11880 2670000 | 622.3 24.50 | 7.9 0.31 | – | 81.7 180.0 | 9, 10, 11 |
| T711FS-T711SA | 3 | 368.300 14.5000 | 368.300 14.5000 | 101.600 4.0000 | – | 177.800 7.0000 | 298.450 11.7500 | 11880 2670000 | 762.0 30.00 | 7.9 0.31 | 7.9 0.31 | 48.4 106.7 | 9, 10, 11 |
| 148 TTSF926 O0487 | 10 | 377.825 14.8750 | 375.463 14.7820 | 129.007 5.0790 | 25.400 1.0000 | – | – | 17440 3920000 | – | 1.5 0.06 | – | 110.0 243.0 | 10, 11 |
| 148 TTSV 926 A0529 | 7 | 377.825 14.8750 | 375.463 14.7820 | 111.125 4.3750 | 25.400 1.0000 | – | 330.200 13.0000 | 17440 3920000 | 457.2 18.00 | 1.5 0.06 | – | (1) | 10, 11 |
| 148 TTSX 926 | 1 | 377.825 14.8750 | 451.663 17.7820 | 129.007 5.0790 | 25.400 1.0000 | – | 330.200 13.0000 | 17440 3920000 | 914.4 36.00 | 1.6 0.06 | – | 104.2 229.7 | 10, 11 |
| 148 TTSX 926 B0024 | 1 | 377.825 14.8750 | 375.463 14.7820 | 141.707 5.5790 | 38.100 1.5000 | – | 330.200 13.0000 | 17440 3920000 | 914.4 36.00 | 1.5 0.06 | – | 104.2 229.7 | 10, 11 |
| 148 TTSX 926 OB452 | 1 | 377.825 14.8750 | 375.463 14.7820 | 129.007 5.0790 | 25.400 1.0000 | – | 330.200 13.0000 | 17440 3920000 | 711.2 28.00 | 1.5 0.06 | – | 104.2 229.7 | 10, 11 |
| 148 TTSX 926 OD806 | 1 | 377.825 14.8750 | 374.650 14.7500 | 129.007 5.0790 | 25.400 1.0000 | – | 330.200 13.0000 | 17440 3920000 | 1384.3 54.50 | 1.5 0.06 | – | 104.2 229.7 | 10, 11 |
| 161 TTSV 930 OA534 | 7 | 409.575 16.1250 | 407.213 16.0320 | 139.700 5.5000 | 28.575 1.1250 | – | 330.200 13.0000 | 20420 4590000 | 508.0 20.00 | 3.0 0.12 | – | (1) | 10, 11 |
| 161 TTSX 930 | 1 | 409.575 16.1250 | 407.213 16.0320 | 140.767 5.5420 | 28.575 1.1250 | – | 355.600 14.0000 | 20420 4590000 | 1016.0 40.00 | 3.2 0.13 | – | 134.8 297.1 | 10, 11 |

(1) Contact your Timken engineer.

NOTE: Spec. = Special tolerance structure, contact your Timken engineer.

Continued on next page.

THRUST BEARING DATA

THRUST TAPERED ROLLER BEARINGS – SCREWDOWN BEARINGS – TYPES TTHDSX/SV AND TTHDFLSX/SV

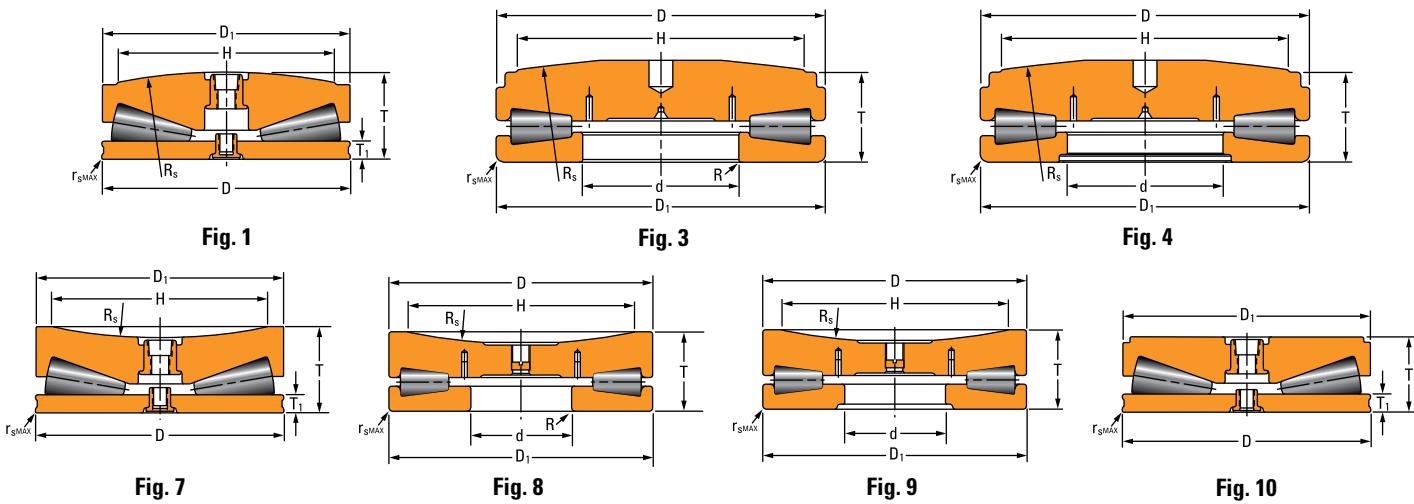

TABLE 49. SCREWDOWN BEARINGS – TYPES TTHDSX/SV AND TTHDFLSX/SV – continued

| Bearing Part Number | Figure No. | Bearing Dimensions | | | | | | Static Load Rating C_{a0} | Mounting Dimensions | | | Bearing Weight | Tolerance Table |
|---------------------|------------|--------------------|--------------------|-------------------|-------------------|-------------------|--------------------------|--------------------------------|---------------------|--------------------|-------------|----------------|-----------------|
| | | Large O.D. | Small O.D. | Bearing Width | Flat Race Width | Bore | Screw Extension Diameter | | Spherical Radius | | R | | |
| | | D | D ₁ | T | T ₁ | d | H | | R _s | r _{s max} | | | |
| mm in. | mm in. | mm in. | mm in. | mm in. | mm in. | mm in. | mm in. | mm in. | mm in. | kg lbs. | | | |
| 161 TTSX 930 D0035 | 1 | 409.575 16.1250 | 407.213 16.0320 | 140.767 5.5420 | 28.575 1.1250 | – | 355.600 14.0000 | 20420 4590000 | 1016.0 40.00 | 3.0 0.12 | – | 134.8 297.1 | 10, 11 |
| T811FSA-T811SB | 8 | 422.275 16.6250 | 419.100 16.5000 | 120.650 4.7500 | – | – | 342.900 13.5000 | 15080 3390000 | 508.0 20.00 | 9.7 0.38 | – | 104.0 229.3 | 9, 10, 11 |
| T811FS-T811SA | 3 | 422.275 16.6250 | 419.100 16.5000 | 115.888 4.5625 | – | 203.200 8.0000 | 342.900 13.5000 | 15080 3390000 | 838.2 33.00 | 9.7 0.38 | 9.7 0.38 | 106.3 234.3 | 9, 10, 11 |
| 172 TTSF 934 | 10 | 438.150 17.2500 | 435.788 17.1570 | 130.175 5.1250 | 31.750 1.2500 | – | – | 23840 5360000 | – | 3.0 0.12 | – | (1) | 10, 11 |
| 172 TTSV 934 BA528 | 7 | 438.150 17.2500 | 435.788 17.1570 | 149.225 5.8750 | 50.800 2.0000 | – | 381.000 15.0000 | 23840 5360000 | 1270.0 50.00 | – | – | (1) | 10, 11 |
| 172 TTSX 934 | 1 | 438.150 17.2500 | 435.788 17.1570 | 150.673 5.9320 | 130.175 5.1250 | – | 381.000 15.0000 | 23840 5360000 | 1016.0 40.00 | 3.0 0.12 | – | 163.6 360.8 | 10, 11 |
| D-2271-C | 10 | 438.150 17.2500 | 438.150 17.2500 | 130.175 5.1250 | 31.750 1.2500 | – | – | 23840 5360000 | – | 3.2 0.13 | – | 141.4 311.7 | 10, 11 |
| S-3229-B | 7 | 457.200 18.0000 | 448.462 17.6560 | 161.925 6.3750 | 31.750 1.2500 | – | 336.550 13.2500 | 26290 5910000 | 508.0 20.00 | 3.0 0.12 | – | (1) | 10, 11 |
| 190 TTSX 940 OA617 | 1 | 482.600 19.0000 | 480.187 18.9050 | 152.781 6.0150 | 38.100 1.5000 | – | 419.100 16.5000 | 29220 6570000 | 1066.8 42.00 | 1.5 0.06 | – | 170.8 376.4 | 10, 11 |
| B-6096-C | 7 | 482.600 19.0000 | 482.600 19.0000 | 146.050 5.7500 | 38.291 1.5075 | – | 431.800 17.0000 | 27930 6280000 | 1270.0 50.00 | – | – | 171.2 377.4 | Spec. |
| B-6593-C | 7 | 482.600 19.0000 | 482.600 19.0000 | 152.400 6.0000 | 44.641 1.7575 | – | 431.800 17.0000 | 6310 28070000 | 1270.0 50.00 | – | – | 131.5 290.0 | Spec. |
| T9030FSA-T9030SA | 4 | 482.600 19.0000 | 482.600 19.0000 | 131.763 5.1875 | – | 168.275 6.6250 | 419.100 16.5000 | 20640 4640000 | 1295.4 51.00 | 11.2 0.44 | – | 170.2 375.2 | 9, 10, 11 |
| T9030FSA-T9030SB | 4 | 482.600 19.0000 | 482.600 19.0000 | 131.763 5.1875 | – | 168.275 6.6250 | 419.100 16.5000 | 20640 4640000 | 1066.8 42.00 | 11.2 0.44 | – | 170.2 375.2 | 9, 10, 11 |
| T9030FS-T9030SA | 3 | 482.600 19.0000 | 482.600 19.0000 | 150.622 5.9300 | – | – | 419.100 16.5000 | 20640 4640000 | 1295.4 51.00 | 11.2 0.44 | – | 204.6 451.0 | 9, 10, 11 |
| T911FS-T911S | 9 | 482.600 19.0000 | 482.600 19.0000 | 146.050 5.7500 | – | 228.600 9.0000 | 428.625 16.8750 | 20280 4560000 | 608.3 23.95 | 11.2 0.44 | – | 149.8 330.2 | 9, 10, 11 |

(1) Contact your Timken engineer.

NOTE: Spec. = Special tolerance structure, contact your Timken engineer.

Continued on next page.

THRUST TAPERED ROLLER BEARINGS – SCREWDOWN BEARINGS – TYPES TTHDSX/SV AND TTHDFLSX/SV

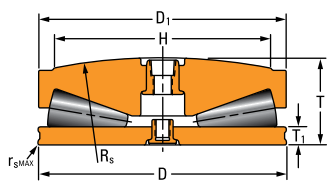

Fig. 1

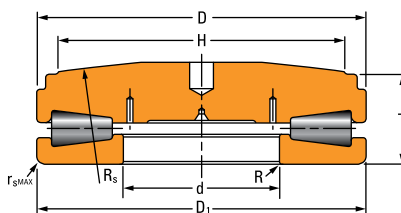

Fig. 3

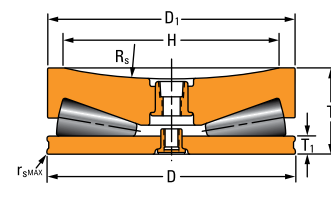

Fig. 7

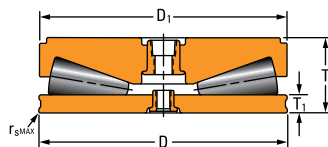

Fig. 10

Continued from previous page.

| Bearing Part Number | Figure No. | Bearing Dimensions | | | | | | Static Load Rating | Mounting Dimensions | | | Bearing Weight | Tolerance Table |
|---------------------|------------|--------------------|--------------------|-------------------|------------------|-----------|--------------------------|--------------------|---------------------|--------------|---|----------------|-----------------|
| | | Large O.D. | Small O.D. | Bearing Width | Flat Race Width | Bore | Screw Extension Diameter | | Spherical Radius | $r_{s\ max}$ | R | | |
| | | D | D ₁ | T | T ₁ | d | H | | R _s | | | | |
| mm in. | mm in. | mm in. | mm in. | mm in. | mm in. | mm in. | mm in. | mm in. | mm in. | kg lbs. | | | |
| T9030FSB-T9030SC | 3 | 492.811 19.4020 | 495.249 19.4980 | 145.288 5.7200 | – | – | 431.800 17.0000 | 20640 4640000 | 1066.8 42.00 | 3.0 0.12 | – | (1) | 9, 10, 11 |
| 195 TTSF 938 | 10 | 495.300 19.5000 | 492.938 19.4070 | 145.288 5.7200 | 34.925 1.3750 | – | – | 29540 6640000 | – | 3.0 0.12 | – | 184.5 406.7 | 10, 11 |
| 195 TTSV 938 OA452 | 7 | 495.300 19.5000 | 492.938 19.4070 | 146.050 5.7500 | 34.925 1.3750 | – | 431.800 17.0000 | 29540 6640000 | 635.0 25.00 | 3.2 0.13 | – | 162.8 358.9 | 10, 11 |
| 195 TTSV 938 OC902 | 7 | 495.300 19.5000 | 488.950 19.2500 | 146.050 5.7500 | 34.925 1.3750 | – | 431.800 17.0000 | 29540 6640000 | 635.0 25.00 | 3.0 0.12 | – | 162.8 358.9 | 10, 11 |
| 195 TTSX 938 | 1 | 495.300 19.5000 | 492.938 19.4070 | 170.612 6.7170 | 34.925 1.3750 | – | 431.800 17.0000 | 29540 6640000 | 1066.8 42.00 | 3.0 0.12 | – | 205.4 452.7 | 10, 11 |
| 195 TTSX 938 G01185 | 1 | 495.300 19.5000 | 492.938 19.4070 | 170.612 6.7170 | 34.925 1.3750 | – | 431.800 17.0000 | 29540 6640000 | 1066.8 42.00 | 3.0 0.12 | – | 204.4 450.7 | 10, 11 |
| 195 TTSX 938 OG547 | 1 | 495.300 19.5000 | 495.300 19.5000 | 170.612 6.7170 | 34.925 1.3750 | – | 431.800 17.0000 | 29540 6640000 | 1066.8 42.00 | 3.0 0.12 | – | 204.4 450.7 | Spec. |
| 195 TTSX 938 OM1907 | 1 | 495.300 19.5000 | 492.938 19.4070 | 170.612 6.7170 | 34.925 1.3750 | – | 431.800 17.0000 | 29540 6640000 | 1066.8 42.00 | 3.0 0.12 | – | 204.4 450.7 | 10, 11 |
| 202 TTSX 942 FE1199 | 1 | 514.350 20.2500 | 521.513 20.5320 | 188.722 7.4300 | 34.925 1.3750 | – | 403.225 15.8750 | 35630 8010000 | 635.0 25.00 | 1.5 0.06 | – | 238.5 525.9 | 10, 11 |
| 206 TTSV 942 | 7 | 523.875 20.6250 | 521.513 20.5320 | 152.400 6.0000 | 34.925 1.3750 | – | 457.200 18.0000 | 35630 8010000 | 635.0 25.00 | 3.0 0.12 | – | 190.8 420.6 | 10, 11 |
| 206 TTSX 942 | 1 | 523.875 20.6250 | 521.513 20.5320 | 175.768 6.9200 | 34.925 1.3750 | – | 457.200 18.0000 | 35630 8010000 | 1270.0 50.00 | 3.0 0.12 | – | 258.0 568.0 | 10, 11 |
| 206 TTSX 942 B0529 | 1 | 523.875 20.6250 | 521.513 20.5320 | 175.768 6.9200 | 34.925 1.3750 | – | 457.200 18.0000 | 35630 8010000 | 1270.0 50.00 | 3.2 0.13 | – | 258.0 568.0 | 10, 11 |
| 210 TTSV 944 CA1481 | 7 | 533.400 21.0000 | 533.400 21.0000 | 177.800 7.0000 | 31.750 1.2500 | – | 457.200 18.0000 | 36650 8240000 | 1270.0 50.00 | 1.5 0.06 | – | 257.0 567.0 | Spec. |
| 210 TTSV 944 DA1708 | 7 | 533.400 21.0000 | 533.400 21.0000 | 190.500 7.5000 | 44.450 1.7500 | – | 457.200 18.0000 | 36650 8240000 | 1270.0 50.00 | – | – | 279.5 616.0 | Spec. |
| 210 TTSX 944 A0574 | 1 | 533.400 21.0000 | 531.012 20.9060 | 177.800 7.0000 | 31.750 1.2500 | – | 457.200 18.0000 | 36650 8240000 | 1981.2 78.00 | – | – | 249.1 549.2 | 10, 11 |

(1) Contact your Timken engineer.

NOTE: Spec. = Special tolerance structure, contact your Timken engineer.

Continued on next page.

THRUST BEARING DATA

THRUST TAPERED ROLLER BEARINGS – SCREWDOWN BEARINGS – TYPES TTHDSX/SV AND TTHDFLSX/SV

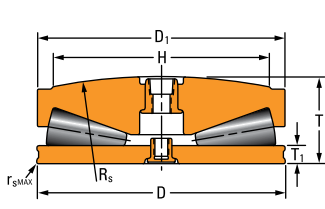

Fig. 1

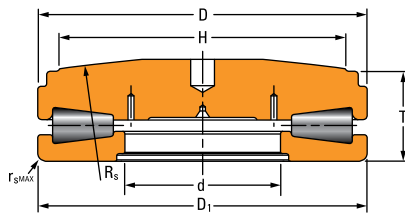

Fig. 4

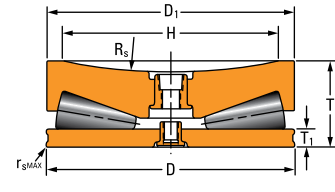

Fig. 7

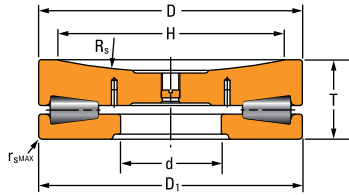

Fig. 9

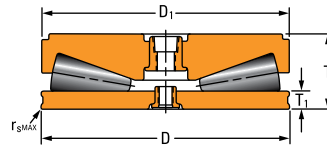

Fig. 10

TABLE 49. SCREWDOWN BEARINGS – TYPES TTHDSX/SV AND TTHDFLSX/SV – continued

| Bearing Part Number | Figure No. | Bearing Dimensions | | | | | | Static Load Rating | Mounting Dimensions | | | Bearing Weight | Tolerance Table |
|---------------------|------------|--------------------|--------------------|-------------------|------------------|--------------------|--------------------------|--------------------|---------------------|--------------------|-----------|----------------|-----------------|
| | | Large O.D. | Small O.D. | Bearing Width | Flat Race Width | Bore | Screw Extension Diameter | | Spherical Radius | | | | |
| | | D | D ₁ | T | T ₁ | d | H | | R _s | r _{s max} | R | | |
| | | mm in. | mm in. | mm in. | mm in. | mm in. | mm in. | kN lbf. | mm in. | mm in. | mm in. | kg lbs. | |
| 210 TTSX 944 BA1479 | 1 | 533.400 21.0000 | 533.400 21.0000 | 177.800 7.0000 | 31.750 1.2500 | – | 457.200 18.0000 | 36650 8240000 | 1981.2 78.00 | – | – | 271.0 598.0 | 10, 11 |
| B-6435-C | 7 | 533.400 21.0000 | – | 190.500 7.5000 | 50.991 2.0075 | – | – | 37630 8460000 | 1270.0 50.00 | – | – | (1) | Spec. |
| D-2272-C | 1 | 533.400 21.0000 | 533.400 21.0000 | 190.500 7.5000 | 31.750 1.2500 | – | 469.392 18.4800 | 39190 8810000 | 1220.8 48.06 | 2.5 0.10 | – | 224.2 494.3 | Spec. |
| A-6639-A | 1 | 533.451 21.0020 | 533.400 21.0000 | 190.500 7.5000 | 31.750 1.2500 | – | 469.392 18.4800 | 39190 8810000 | 1235.5 48.64 | 2.5 0.10 | – | 287.0 673.0 | Spec. |
| 210 TTSF 944 | 10 | 535.991 21.1020 | 535.991 21.1020 | 189.992 7.4800 | 31.750 1.2500 | – | – | 36650 8240000 | – | 2.0 0.08 | – | 274.0 604.0 | Spec. |
| 212 TTSV 942 EB1876 | 7 | 539.750 21.2500 | 539.750 21.2500 | 196.850 7.7500 | 41.275 1.6250 | – | 406.400 16.0000 | 35630 8010000 | 635.0 25.00 | 11.2 0.44 | – | 288.0 635.0 | Spec. |
| T1011FS-T1011S | 4 | 539.750 21.2500 | 539.750 21.2500 | 149.225 5.8750 | – | 254.000 10.0000 | 447.751 17.6280 | 25670 5770000 | 1066.8 42.00 | 11.2 0.44 | – | 225.8 497.8 | 9, 10, 11 |
| T9250FS-T9250S | 9 | 546.100 21.5000 | 546.100 21.5000 | 168.275 6.6250 | – | 234.950 9.2500 | 457.200 18.0000 | 29980 6740000 | 641.4 25.25 | 16.0 0.63 | – | 222.2 489.8 | 9, 10, 11 |
| T9250FAS-T9250SA | 4 | 549.275 21.6250 | 546.100 21.5000 | 155.575 6.1250 | – | 139.700 5.5000 | 457.200 18.0000 | 29980 6740000 | 1295.4 51.00 | 16.0 0.63 | – | 265.7 585.8 | 9, 10, 11 |
| M-4153-C | 7 | 551.688 21.7200 | 539.750 21.2500 | 158.369 6.2350 | 25.400 1.0000 | – | 406.400 16.0000 | 35900 8070000 | 635.0 25.00 | 3.0 0.12 | – | 294.8 650.0 | 10, 11 |
| 218 TTSV 946 | 7 | 555.625 21.8750 | 553.263 21.7820 | 165.100 6.5000 | 38.100 1.5000 | – | 482.600 19.0000 | 38340 8620000 | 635.0 25.00 | 3.2 0.13 | – | 288.4 635.7 | 10, 11 |
| 218 TTSX 946 | 1 | 555.625 21.8750 | 553.263 21.7820 | 190.856 7.5140 | 38.100 1.5000 | – | 482.600 19.0000 | 38340 8620000 | 1270.0 50.00 | 3.0 0.12 | – | 284.4 626.9 | 10, 11 |
| B-6903-C | 1 | 555.625 21.8750 | 553.263 21.7820 | 227.787 8.9680 | 63.500 2.5000 | – | 425.450 16.7500 | 32870 7390000 | 1930.4 76.00 | – | – | 352.5 777.1 | Spec. |
| B-8867-G | 1 | 555.625 21.8750 | 553.263 21.7820 | 201.828 7.9460 | 38.100 1.5000 | – | 482.600 19.0000 | 37540 8440000 | 1930.4 76.00 | – | – | 373.0 867.0 | 10, 11 |
| S-4674-G | 10 | 577.850 22.7500 | 581.025 22.8750 | 228.600 9.0000 | 50.800 2.0000 | – | – | 43500 9780000 | – | – | – | 434.0 957.0 | Spec. |

(1) Contact your Timken engineer.

NOTE: Spec. = Special tolerance structure, contact your Timken engineer.

Continued on next page.

THRUST TAPERED ROLLER BEARINGS – SCREWDOWN BEARINGS – TYPES THDSX/SV AND THDFLSX/SV

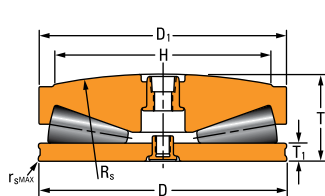

Fig. 1

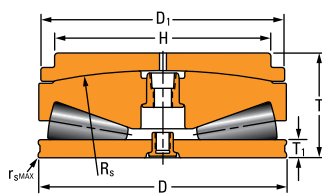

Fig. 2

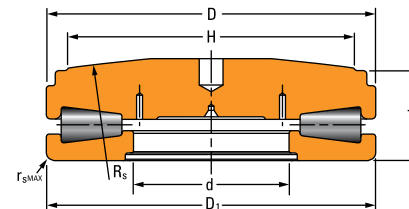

Fig. 4

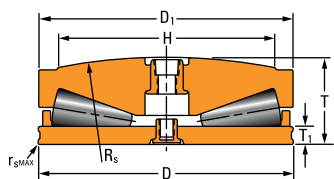

Fig. 5

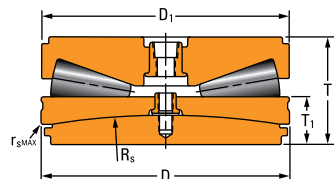

Fig. 6

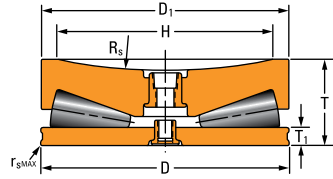

Fig. 7

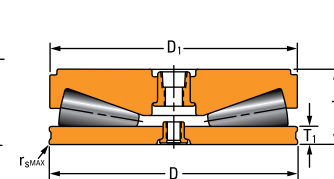

Fig. 10

Continued from previous page.

| Bearing Part Number | Figure No. | Bearing Dimensions | | | | | | Static Load Rating C_{a0} | Mounting Dimensions | | | Bearing Weight | Tolerance Table |
|---------------------|------------|--------------------|--------------------|-------------------|-------------------|--------------------|--------------------------|--------------------------------|---------------------|--------------|-----------|-----------------|-----------------|
| | | Large O.D. | Small O.D. | Bearing Width | Flat Race Width | Bore | Screw Extension Diameter | | Spherical Radius | $r_{s\max}$ | R | | |
| | | D | D_1 | T | T_1 | d | H | | R_s | | | | |
| | | mm in. | mm in. | mm in. | mm in. | mm in. | mm in. | kN lbf. | mm in. | mm in. | mm in. | kg lbs. | |
| 228 TTSF 950 BA1668 | 10 | 581.025 22.8750 | 578.663 22.7820 | 167.894 6.6100 | 38.100 1.5000 | – | – | 43500 9780000 | – | 3.0 0.12 | – | 297.0 655.0 | 23, 23 |
| 228 TTSX 950 | 1 | 581.025 22.8750 | 578.663 22.7820 | 193.777 7.6290 | 38.100 1.5000 | – | 508.000 20.0000 | 43500 9780000 | 1422.4 56.00 | 3.0 0.12 | – | 318.0 701.1 | 10, 11 |
| 228 TTSX 950 A02017 | 1 | 581.025 22.8750 | 578.663 22.7820 | 193.777 7.6290 | 38.100 1.5000 | – | 508.000 20.0000 | 43500 9780000 | 1422.4 56.00 | 3.0 0.12 | – | 431.0 950.0 | 10, 11 |
| S-3632-C | 6 | 581.025 22.8750 | 581.025 22.8750 | 240.005 9.4490 | 107.950 4.2500 | – | – | 39140 8800000 | 1270.0 50.00 | 1.5 0.06 | – | (1) | Spec. |
| R-3355-A | 1 | 603.250 23.7500 | 601.675 23.6880 | 207.620 8.1740 | 44.450 1.7500 | – | 495.300 19.5000 | 43500 9780000 | 1308.1 51.50 | 4.8 0.19 | – | 431.0 950.0 | Spec. |
| T1120FS-T1120S | 4 | 603.250 23.7500 | 603.250 23.7500 | 161.925 6.3750 | – | 279.400 11.0000 | 482.600 19.0000 | 33410 7510000 | 1308.1 51.50 | 11.2 0.44 | – | 306.4 675.6 | 9, 10, 11 |
| 240 TTSF 954 | 10 | 609.600 24.0000 | 607.238 23.9070 | 177.038 6.9700 | 38.100 1.5000 | – | – | 48930 11000000 | – | 3.0 0.12 | – | (1) | Spec. |
| 240 TTSX 954 | 1 | 609.600 24.0000 | 607.238 23.9070 | 204.013 8.0320 | 38.100 1.5000 | – | 533.400 21.0000 | 48930 11000000 | 1524.0 60.00 | 3.0 0.12 | – | 370.4 816.6 | 10, 11 |
| S-21292-C | 2 | 609.600 24.0000 | 710.006 27.9530 | 253.660 9.9866 | 38.037 1.4975 | – | 585.000 23.0315 | 48930 11000000 | 1524.0 60.00 | 3.3 0.13 | – | 494.0 1088.0 | Spec. |
| T-5263-C | 10 | 638.226 25.1270 | – | 184.150 7.2500 | 38.100 1.5000 | – | – | 53380 12000000 | – | 3.0 0.12 | – | (1) | Spec. |
| 252 TTSF 958 | 10 | 641.350 25.2500 | 638.988 25.1570 | 205.740 8.1000 | 38.100 1.5000 | – | – | 52930 11900000 | – | 3.0 0.12 | – | 432.0 952.0 | 10, 11 |
| 252 TTSV 958 | 7 | 641.350 25.2500 | 638.988 25.1570 | 184.150 7.2500 | 38.100 1.5000 | – | 558.800 22.0000 | 52930 11900000 | 762.0 30.00 | 3.2 0.13 | – | 580.0 858.0 | 10, 11 |
| 252 TTSX 958 | 1 | 641.350 25.2500 | 638.988 25.1570 | 212.674 8.3730 | 38.100 1.5000 | – | 558.800 22.0000 | 52930 11900000 | 1524.0 60.00 | 3.0 0.12 | – | 424.0 933.0 | 10, 11 |
| N-21041-B | 1 | 641.350 25.2500 | 638.988 25.1570 | 212.674 8.3730 | 38.100 1.5000 | – | 558.800 22.0000 | 52930 11900000 | 1524.0 60.00 | 3.0 0.12 | – | 424.0 934.0 | 10, 11 |
| B-9122-A | 5 | 692.150 27.2500 | 689.762 27.1560 | 233.629 9.1980 | 38.100 1.5000 | – | 590.550 23.2500 | 52490 11800000 | 1524.0 60.00 | 3.0 0.12 | – | 603.0 1329.0 | Spec. |

(1) Contact your Timken engineer.

NOTE: Spec. = Special tolerance structure, contact your Timken engineer.

THRUST BEARING DATA

THRUST TAPERED ROLLER BEARING – TYPES TTHDSX/SV AND TTHDFLSX/SV

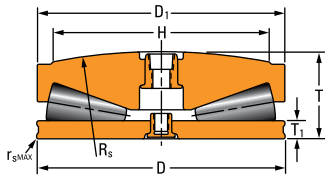

Fig. 1

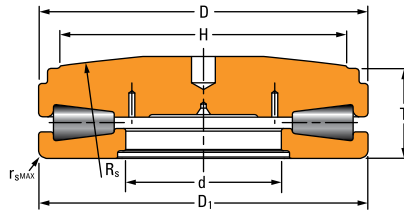

Fig. 4

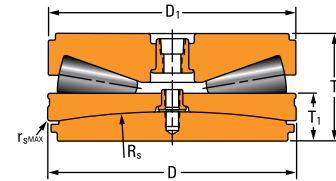

Fig. 6

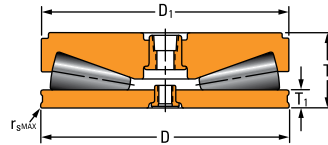

Fig. 10

TABLE 49. SCREWDOWN BEARINGS – TYPES TTHDSX/SV AND TTHDFLSX/SV – continued

| Bearing Part Number | Figure No. | Bearing Dimensions | | | | | | Static Load Rating | Mounting Dimensions | | | Bearing Weight | Tolerance Table |
|---------------------|------------|---------------------|---------------------|--------------------|-------------------|--------------------|--------------------------|--------------------|---------------------|--------------------|------------|------------------|-----------------|
| | | Large O.D. | Small O.D. | Bearing Width | Flat Race Width | Bore | Screw Extension Diameter | | Spherical Radius | | | | |
| | | D | D ₁ | T | T ₁ | d | H | | R _s | r _{s max} | R | | |
| | | mm in. | mm in. | mm in. | mm in. | mm in. | mm in. | mm in. | mm in. | mm in. | kg lbs. | | |
| S-4718-A | 1 | 840.000 33.0709 | 838.000 32.9920 | 281.610 11.0870 | 44.450 1.7500 | – | 725.000 28.5430 | 91190 20500000 | 1524.0 60.00 | – | – | 986.0 2174.0 | Spec. |
| V-505-A | 10 | 840.000 33.0709 | 838.000 32.9920 | 249.619 9.8275 | 44.450 1.7500 | – | – | 91190 20500000 | – | 3.2 0.13 | – | 916.0 2019.0 | 10, 11 |
| N-21100-C | 6 | 850.000 33.4646 | 850.000 33.4646 | 360.000 14.1732 | 194.350 7.6515 | – | – | 78290 17600000 | 1500.0 59.06 | – | – | 1350.0 2955.0 | Spec. |
| T17020FS-T17020S | 4 | 942.975 37.1250 | 939.800 37.0000 | 260.350 10.2500 | – | 431.800 17.0000 | 762.000 30.0000 | 82290 18500000 | 2000.3 78.75 | 12.7 0.50 | – | 1260.0 2776.0 | 9, 10, 11 |
| T12040FS-T12040S | 4 | 1146.175 45.1250 | 1143.000 45.0000 | 317.500 12.5000 | – | 304.800 12.0000 | 990.600 39.0000 | 136560 30700000 | 2000.3 78.75 | 19.1 0.75 | – | 2530.0 5577.0 | 9, 10, 11 |

(1) Contact your Timken engineer.

NOTE: Spec. = Special tolerance structure, contact your Timken engineer.

TYPE TTDWK AND TTDFLK

- Double-acting thrust tapered roller bearing construction.
- Used extensively on work roll axial positions in metals rolling mill applications where axial loads are very high.
- Design variants include one tapered inner race and two flat outer races, or one flat inner race and two tapered outer races.

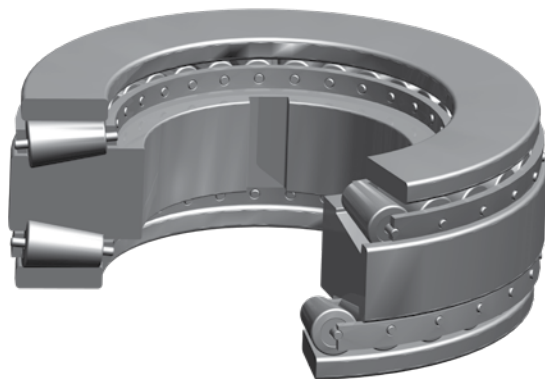

Fig. 100. Type TTDWK double-row thrust tapered roller bearing.

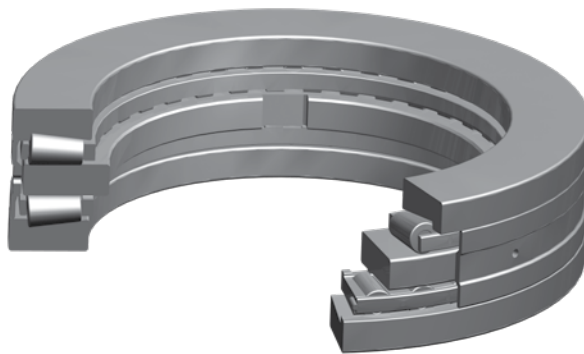

Fig. 101. Type TTDFLK double-row thrust tapered roller bearing.

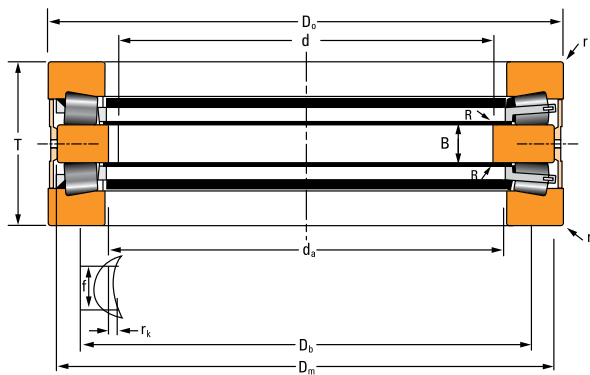

Fig. 102. Type TTDFLK double-row thrust tapered roller bearing assembly.

OVERALL DIMENSIONS:

- d – Bore diameter
- D₀ – Outer rings O.D.
- D_m – Inner ring O.D.
- D_b – Outer ring backing diameter
- T – Bearing width
- B – Inner ring width
- R – Shaft maximum fillet radius
- r – Housing maximum fillet radius
- r_k – Keyway height
- f – Keyway width
- b – Keyway depth (where applicable)

DESIGN TYPES

TTDW

- Two single flat outer races.
- One double tapered inner race with extended ribs.
- Oil slots on double race faces.

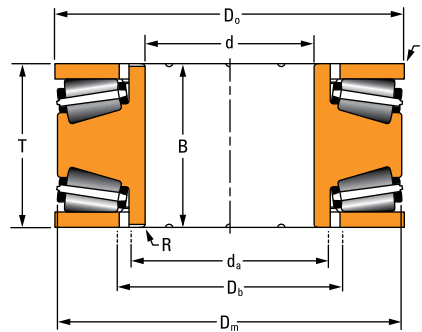

Fig. 103. Type TTDW.

TTDK 1

- Two single flat outer races.
- One double tapered inner race.
- Inner-ring bore keyway.

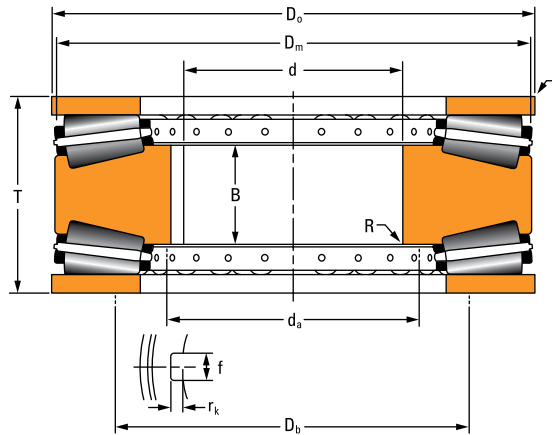

Fig. 104. Type TTDK 1.

TTDK 2

- Two single flat outer races.
- One double tapered inner race.
- One outer-ring spacer with oil groove.

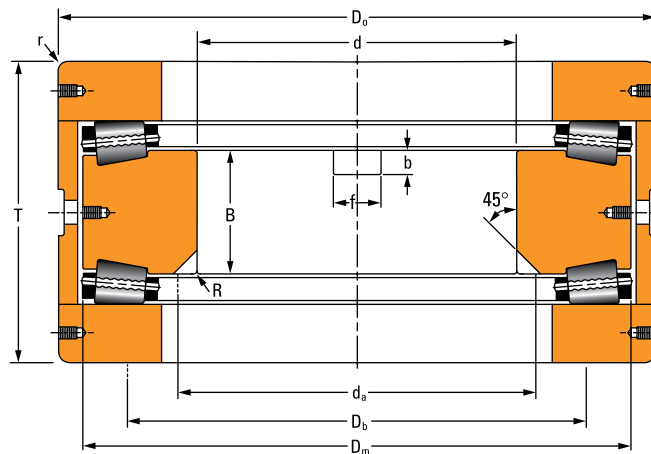

Fig. 105. Type TTDK 2.

TTDFLK 1

- Two single tapered outer races.
- One flat inner race.
- Inner-ring bore keyway (optional).
- One outer-ring spacer with oil slots.

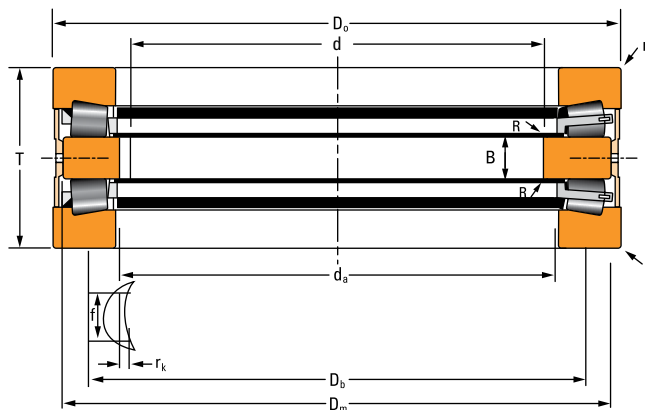

Fig. 106. Type TTDFLK 1.

TTDFLK 2

- Two single tapered outer races.
- One flat inner race.
- Inner-ring face keyway (optional).
- One outer-ring spacer with oil slots.

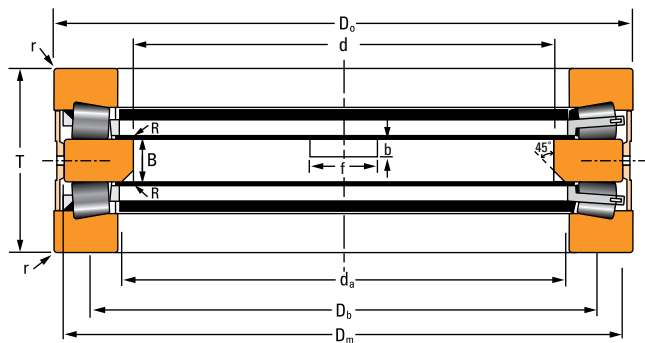

Fig. 107. Type TTDFLK 2.

THRUST BEARING DATA

THRUST TAPERED ROLLER BEARINGS – TYPES TTDWK AND TTDFLK

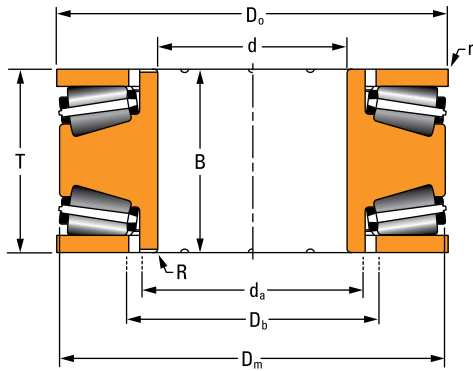

Fig. 1

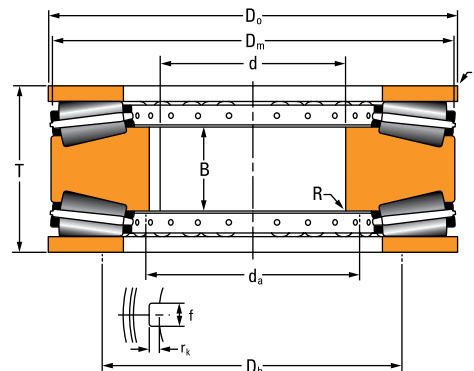

Fig. 2

TABLE 50. THRUST TAPERED ROLLER BEARINGS – TYPES TTDWK AND TTDFLK

| Bearing Part Number | | Figure No. | Bearing Dimensions | | | | Cage Type ⁽¹⁾ | |
|---------------------|--------------------|------------|--------------------|--------------------|--------------------|--------------------|--------------------------|------------------|
| Thrust Race Double | Thrust Race Single | | Bore | O.D. | | Bearing Width | | Inner Ring Width |
| | | | d | D_o | D_m | T | | B |
| | | mm in. | mm in. | mm in. | mm in. | mm in. | | |
| T660DW | T660FA | 2 | 142.000 5.5906 | 293.000 11.5354 | 304.800 12.0000 | 130.000 5.1180 | 55.000 2.1654 | P |
| T730DW | T730FA | 2 | 170.000 6.6929 | 249.970 9.8413 | 246.913 9.7210 | 70.000 2.7559 | 19.000 0.7480 | P |
| T6110F | T6110 | 4 | 170.000 6.6929 | 240.000 9.4488 | 228.600 9.0000 | 84.000 3.3070 | 20.000 0.7874 | MB |
| T770DW | T770FA | 2 | 180.000 7.0866 | 279.975 11.0226 | 275.000 10.8268 | 90.000 3.5433 | 31.826 1.2490 | P |
| H-21033-B | - | 4 | 180.000 7.0866 | 280.000 11.0236 | 263.000 10.3500 | 90.000 3.5433 | 20.000 0.7874 | MB |
| T7020F | T7020 | 4 | 180.000 7.0866 | 280.000 11.0236 | 265.000 10.4330 | 90.000 3.5433 | 20.000 0.7874 | MB |
| T8011DW | T8011F | 2 | 203.200 8.0000 | 390.855 15.3880 | 403.860 15.9000 | 152.400 6.0000 | 72.898 2.8700 | P |
| T8010DW | T8010F | 1 | 203.200 8.0000 | 431.317 16.9810 | 403.860 15.9000 | 152.400 6.0000 | 152.400 6.0000 | P |
| T8110F | T8110 | 4 | 220.000 8.6614 | 300.000 11.8110 | 289.000 11.3770 | 96.000 3.7795 | 22.000 0.8661 | MB |
| T1080DW | T1080FA | 2 | 250.000 9.8425 | 379.949 14.9586 | 375.000 14.7638 | 100.000 3.9370 | 36.576 1.4400 | P |
| T9130FW | T9130 | 4 | 250.000 9.8425 | 380.000 14.9606 | 364.000 14.3307 | 100.000 3.9370 | 22.000 0.8661 | MB |
| T10400F | T10400 | 4 | 260.000 10.2362 | 360.000 14.1732 | 344.000 13.5433 | 92.000 3.6620 | 20.000 0.7874 | MB |
| T10250DW | T10250F | 1 | 260.350 10.2500 | 584.124 22.9970 | 533.400 21.0000 | 222.250 8.7500 | 222.250 8.7500 | P |
| M-21135-C | H-21120-C | 5 | 291.150 11.4626 | 519.940 20.4701 | 480.000 18.8976 | 265.900 10.4685 | 118.000 4.6457 | MB |
| T12100F | T12100 | 4 | 320.000 12.5984 | 470.000 18.5039 | 448.000 17.6378 | 130.000 5.1181 | 30.000 1.1811 | MB |

⁽¹⁾Cage type: P – Pin MB – Machined Bronze

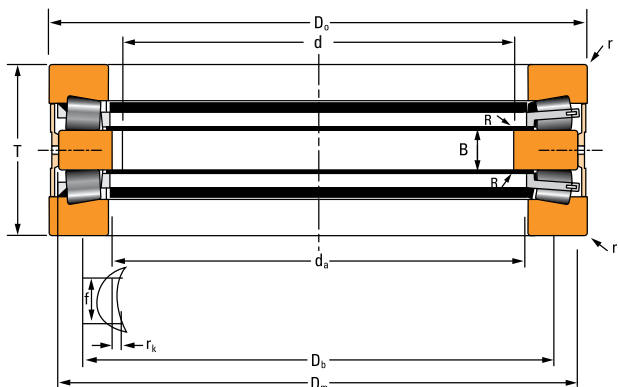

Fig. 4

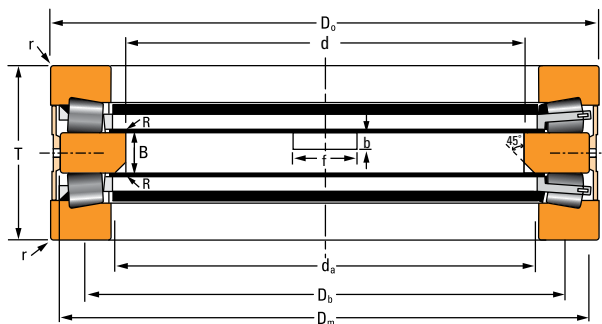

Fig. 5

| Mounting Dimensions | | | | Keyway Dimensions | | | Load Ratings | | | Bearing Weight |
|---------------------|-----------------------------|---------------------|-----------------------------|-------------------|--------------|--------------|-----------------------|------------------------|--------------------|----------------|
| Max Shaft Radius | Inner Ring Backing Diameter | Max. Housing Radius | Outer Ring Backing Diameter | f | b | r_k | Dynamic | | Static Load Rating | |
| | | | | | | | 1 Million Revolutions | 90 Million Revolutions | | |
| R | d_a | r | D_b | | | | C_{a1} | C_{a90} | C_{a0} | |
| mm in. | mm in. | mm in. | mm in. | mm in. | mm in. | mm in. | kN lbf. | kN lbf. | kN lbf. | kg lbs. |
| 1.5 0.06 | 162.0 6.38 | 3.3 0.13 | 168.0 6.61 | 30.0 1.18 | – | 9.0 0.35 | 1900 426200 | 500 111000 | 6510 1460000 | 44.0 97.0 |
| 1.5 0.06 | 182.9 7.20 | 3.3 0.13 | 186.0 7.32 | 30.0 1.18 | – | 6.0 0.24 | 440 97790 | 120 25400 | 1820 408000 | 8.0 18.0 |
| 0.6 0.02 | 182.0 7.17 | 2.0 0.08 | 190.0 7.48 | – | – | – | 500 112850 | 130 29225 | 1600 359690 | 11.0 24.0 |
| 1.5 0.06 | 192.0 7.56 | 3.3 0.13 | 196.0 7.72 | 30.0 1.18 | – | 6.0 0.24 | 720 162470 | 190 42200 | 2990 672000 | 18.0 39.0 |
| 1.0 0.04 | 185.0 7.28 | 2.0 0.08 | 254.0 10.00 | 20.0 0.79 | – | 4.0 0.16 | 764 171760 | 198 44500 | 2510 564300 | 22.0 48.0 |
| 1.0 0.04 | 192.0 7.56 | 2.0 0.08 | 205.0 8.07 | – | – | – | 740 167000 | 190 43160 | 2410 541790 | 20.0 44.0 |
| 1.5 0.06 | 236.5 9.31 | 3.3 0.13 | 260.4 10.25 | 30.0 1.18 | – | 10.0 0.39 | 2850 639100 | 740 166000 | 11900 2670000 | 133.0 294.0 |
| 4.8 0.19 | 235.0 9.25 | 2.0 0.08 | 260.4 10.30 | – | – | – | 2850 639100 | 740 166000 | 11900 2670000 | 158.0 348.0 |
| 1.5 0.06 | 231.0 9.09 | 2.0 0.08 | 245.0 9.65 | – | – | – | 600 135335 | 160 35070 | 2070 465355 | 19.0 42.0 |
| 1.5 0.06 | 266.7 10.50 | 3.3 0.13 | 275.0 10.83 | 30.0 1.18 | – | 7.0 0.28 | 1348 302995 | 350 78700 | 6010 1350000 | 36.0 79.0 |
| 0.6 0.02 | 267.0 10.51 | 2.0 0.08 | 285.0 11.22 | 30.0 1.18 | – | 6.7 0.26 | 1200 269770 | 310 69915 | 5030 1130790 | 40.0 88.0 |
| 2.0 0.08 | 276.0 10.87 | 2.0 0.08 | 290.0 11.42 | – | – | – | 810 182320 | 210 47210 | 3110 699160 | 26.0 57.0 |
| 7.1 0.28 | 304.8 12.00 | 2.0 0.08 | 355.6 14.00 | – | – | – | 5570 1249500 | 1450 324000 | 21600 4850000 | 132.0 292.0 |
| 4.0 0.16 | 340.0 13.39 | 12.7 0.50 | 493.0 19.40 | 46.0 1.81 | 23.0 0.91 | – | 2510 564270 | 650 146130 | 9800 2201300 | 279.0 616.0 |
| 1.1 0.04 | 340.0 13.39 | 3.0 0.12 | 360.0 14.17 | – | – | – | 1770 397910 | 460 103190 | 7670 1724290 | 75.0 165.0 |

Continued on next page.

THRUST BEARING DATA

THRUST TAPERED ROLLER BEARINGS – TYPES TTDWK AND TTDFLK

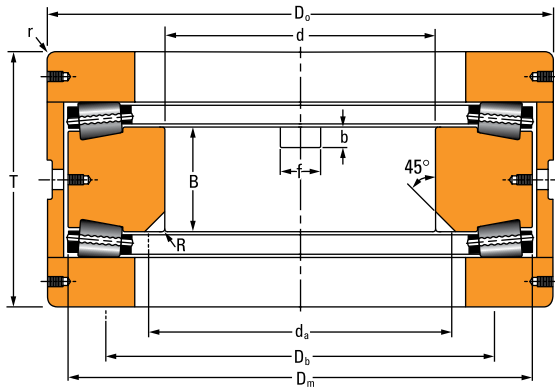

Fig. 3

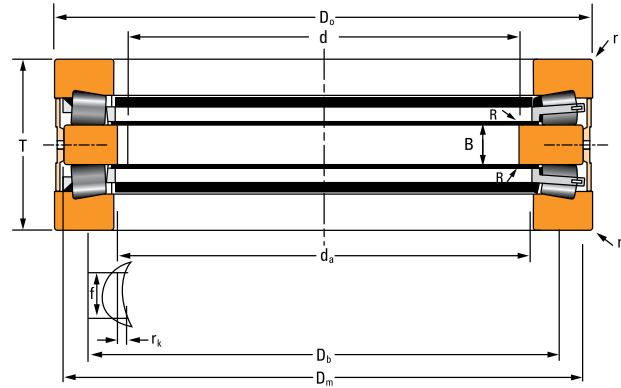

Fig. 4

TABLE 50. THRUST TAPERED ROLLER BEARINGS – TYPES TTDWK AND TTDFLK – continued

| Bearing Part Number | | Figure No. | Bearing Dimensions | | | | | Cage Type ⁽¹⁾ |
|---------------------|--------------------|------------|--------------------|--------------------|--------------------|--------------------|-------------------|--------------------------|
| Thrust Race Double | Thrust Race Single | | Bore | O.D. | | Bearing Width | Inner Ring Width | |
| | | | d | D _o | D _m | T | B | |
| | | mm in. | mm in. | mm in. | mm in. | mm in. | | |
| A-6881-A | A-6888-C | 5 | 336.150 13.2343 | 629.930 24.8004 | 576.961 22.7150 | 318.613 12.5438 | 130.000 5.1181 | MB |
| T13200DW | 13200F | 3 | 336.202 13.2363 | 629.872 24.7981 | 579.247 22.8050 | 318.493 12.5391 | 130.000 5.1181 | P |
| M-21136-C | H-21127-C | 5 | 351.150 13.8248 | 669.925 26.3750 | 610.000 24.0157 | 318.900 12.5551 | 131.000 5.1575 | MB |
| D-3637-A | D-3639-C | 4 | 380.000 14.9606 | 560.000 22.0472 | 538.785 21.2120 | 130.000 5.1181 | 32.000 1.2598 | MB |
| T17200FW | T17200 | 4 | 385.000 15.1575 | 650.000 25.5906 | 614.500 24.1930 | 240.000 9.4488 | 66.000 2.5984 | MB |
| T24000 | T24000F | 4 | 550.000 21.6535 | 760.000 29.9213 | 714.985 28.1490 | 294.500 11.5945 | 114.960 4.5260 | MB |
| F-21063-C | F-21068-B | 4 | 550.000 21.6535 | 760.000 29.9213 | 715.000 28.1500 | 230.000 9.0551 | 49.960 1.9669 | MB |
| D-3327-G | D-3333-C | 5 | 550.000 21.6535 | 760.000 29.9213 | 736.600 29.0000 | 230.000 9.0551 | 50.013 1.9690 | MB |

⁽¹⁾Cage type: P – Pin MB – Machined Bronze

⁽²⁾Contact your Timken engineer.

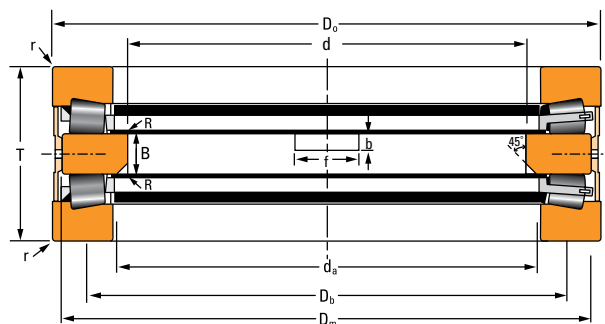

Fig. 5

| Mounting Dimensions | | | | Keyway Dimensions | | | Load Ratings | | | Bearing Weight |
|---------------------|-----------------------------|---------------------|-----------------------------|-------------------|--------------|--------------|-----------------------|------------------------|--------------------|-----------------|
| Max Shaft Radius | Inner Ring Backing Diameter | Max. Housing Radius | Outer Ring Backing Diameter | f | b | r_k | Dynamic | | Static Load Rating | |
| | | | | | | | 1 Million Revolutions | 90 Million Revolutions | | |
| R | d_a | r | D_b | f | b | r_k | C_{a1} | C_{a90} | C_{a0} | |
| mm in. | mm in. | mm in. | mm in. | mm in. | mm in. | mm in. | kN lbf. | kN lbf. | kN lbf. | kg lbs. |
| 4.0 0.16 | 405.0 15.94 | 13.0 0.51 | 588.5 23.17 | 50.0 1.97 | 25.0 0.98 | – | 4200 944200 | 1090 245040 | 18800 4226400 | 513.0 1130.0 |
| 4.1 0.16 | 401.3 15.80 | 13.0 0.51 | 412.0 16.22 | 50.0 1.97 | 25.0 0.98 | – | 3630 816200 | 940 212000 | 15600 3510000 | 107.0 236.0 |
| 3.0 0.12 | 420.0 16.53 | 12.7 0.50 | 622.3 24.50 | 55.0 2.17 | 30.0 1.18 | – | 4330 973400 | 1120 251800 | 18000 4046500 | 588.0 1295.0 |
| 2.8 0.11 | 420.0 16.54 | 3.0 0.12 | 519.1 20.44 | 45.0 1.77 | – | 10.0 0.39 | 2280 512560 | 590 133100 | 10200 2293000 | 96.0 211.0 |
| 3.0 0.12 | 408.9 16.10 | 10.2 0.40 | 456.2 17.96 | 45.5 1.79 | – | 25.4 1.00 | 4850 1090320 | 1260 283260 | 18800 4226410 | 282.0 621.0 |
| 3.0 0.12 | 580.0 22.83 | 6.0 0.24 | 704.5 27.74 | 45.1 1.78 | – | 9.9 0.39 | 3610 812000 | 940 211000 | 13900 3120000 | 373.3 823.0 |
| 3.0 0.12 | 575.0 22.64 | 6.0 0.24 | 705.0 27.75 | 45.1 1.78 | – | 9.9 0.39 | 3620 813800 | 940 210870 | 13900 3124850 | 310.0 683.0 |
| 3.0 0.12 | 609.6 24.00 | 6.4 0.25 | 717.6 28.25 | 50.8 2.00 | 19.0 0.75 | – | 4020 903700 | 1040 233800 | 16600 3731800 | (2) |

CROSSED ROLLER BEARINGS – TYPE TXR

- Compact design which offers lowest possible center of gravity in precision rotational applications.
- Stability of bearings greatly enhanced by effective spread and high stiffness of crossed roller set.
- Ideal choice for table bearing for vertical machining operations
- Provides low starting torque.
- Simplified construction facilitates installation and adjustments.
- Offered in various precision classes.



Fig. 108. Type TXR crossed roller bearing.

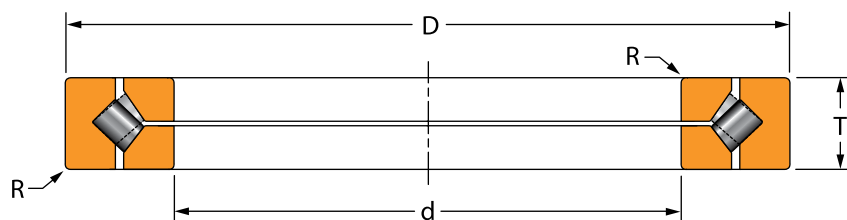

OVERALL DIMENSIONS:

- d – Bore diameter
- D – Bearing O.D.
- T – Bearing width
- R – Shaft/housing maximum fillet radius

Fig. 109. Type TXR crossed roller bearing assembly.

THRUST BEARING DATA

THRUST TAPERED ROLLER BEARINGS – CROSSED ROLLER BEARINGS – TYPE TXR

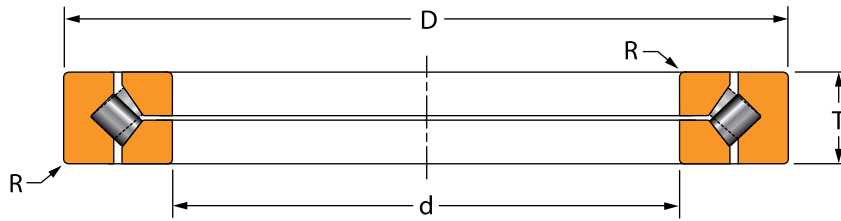

TABLE 51. CROSSED ROLLER BEARINGS – TYPE TXR

| Bearing Part Number | Bearing Dimensions | | | Fillet ⁽¹⁾ Radius (Max.) R | Load Ratings ⁽²⁾ | | Preload ^(4,5) mm in.. | K-Factor ⁽⁶⁾ K | Bearing Weight kg lbs. |
|--------------------------|---------------------|---------------------|-------------------|--|--------------------------------------|-------------------|-------------------------------------|------------------------------|---------------------------|
| | O.D. D | Bore d | Width T | | Radial ⁽³⁾ Load Rating | Axial Load Rating | | | |
| | mm in. | mm in. | mm in. | | kN lbf. | kN lbf. | | | |
| XR496051 | 279.400 11.0000 | 203.200 8.0000 | 31.750 1.2500 | 1.5 0.06 | 51 11500 | 62 13800 | 0.025 to 0.040 0.001 to 0.0015 | 0.48 | 6.1 13.0 |
| JXR637050 ⁽⁷⁾ | 400.000 15.7480 | 300.000 11.8110 | 37.000 1.4567 | 1.5 0.06 | 63 14200 | 80 18000 | 0.025 to 0.040 0.001 to 0.0015 | 0.45 | 13.0 28.0 |
| JXR652050 ⁽⁷⁾ | 425.000 16.7323 | 310.000 12.2047 | 45.000 1.7717 | 2.5 0.10 | 82 18500 | 102 23000 | 0.025 to 0.040 0.001 to 0.0015 | 0.46 | 25.0 55.0 |
| XR678052 | 457.200 18.0000 | 330.200 13.0000 | 63.500 2.5000 | 3.3 0.13 | 100 22500 | 123 27600 | 0.040 to 0.050 0.0015 to 0.002 | 0.47 | 34.8 77.0 |
| JXR699050 ⁽⁷⁾ | 495.000 19.4882 | 370.000 14.5669 | 50.000 1.9685 | 3.0 0.12 | 94 21000 | 119 26700 | 0.040 to 0.050 0.0015 to 0.002 | 0.45 | 76.0 167.0 |
| XR766051 | 609.600 24.0000 | 457.200 18.0000 | 63.500 2.5000 | 3.3 0.13 | 141 31600 | 178 40100 | 0.040 to 0.050 0.0015 to 0.002 | 0.45 | 57.4 127.0 |
| XR820060 | 760.000 29.9213 | 580.000 22.8346 | 80.000 3.1496 | 6.4 0.25 | 240 53900 | 299 67200 | 0.075 to 0.100 0.003 to 0.004 | 0.46 | 102.0 225.0 |
| XR855053 | 914.400 36.0000 | 685.800 27.0000 | 79.375 3.1250 | 3.3 0.13 | 270 60700 | 344 77200 | 0.075 to 0.100 0.003 to 0.004 | 0.45 | 155.5 343.0 |
| XR882055 | 1117.600 44.0000 | 901.700 35.5000 | 82.550 3.2500 | 3.3 0.13 | 300 67400 | 396 88900 | 0.100 to 0.150 0.004 to 0.006 | 0.44 | 195.8 432.0 |
| XR889058 | 1327.150 52.2500 | 1028.700 40.5000 | 114.300 4.5000 | 3.3 0.13 | 405 91000 | 534 120000 | 0.125 to 0.180 0.005 to 0.007 | 0.44 | 436.3 962.0 |
| XR897051 | 1828.800 72.0000 | 1549.400 61.0000 | 101.600 4.0000 | 3.3 0.13 | 518 116000 | 699 157000 | 0.150 to 0.200 0.006 to 0.008 | 0.43 | 512.9 1131.0 |

⁽¹⁾Maximum shaft or housing fillet radius that bearing corners will clear.

⁽²⁾Load calculations based on 500 RPM for 3000 hours.

⁽³⁾Two-row radial load rating shown.

⁽⁴⁾Preload set by adjustments to top inner ring clamping spacer plate.

⁽⁵⁾Values listed apply to lower speed applications. Other preload values are available on request. Contact your Timken representative.

⁽⁶⁾K-factor is a ratio of radial load rating to axial load rating.

⁽⁷⁾Metric size TXR.

NOTE: Application of preload values assumes suggested fitting practice in Engineering Section is used.



To view more Timken catalogs, go to www.timken.com/catalogs for interactive versions, or to download a catalog app for your smart phone or mobile device scan the QR code or go to timkencatalogs.squawqr.com.

TIMKEN

The Timken team applies their know-how to improve the reliability and performance of machinery in diverse markets worldwide. The company designs, makes and markets high-performance mechanical components, including bearings, belts, chain, gears and related mechanical power transmission products and services.

Price: USD \$75

Stronger. By Design.

www.timken.com